

TEAC

Transducer Digital Indicator Instructions for Use

TD-9000T

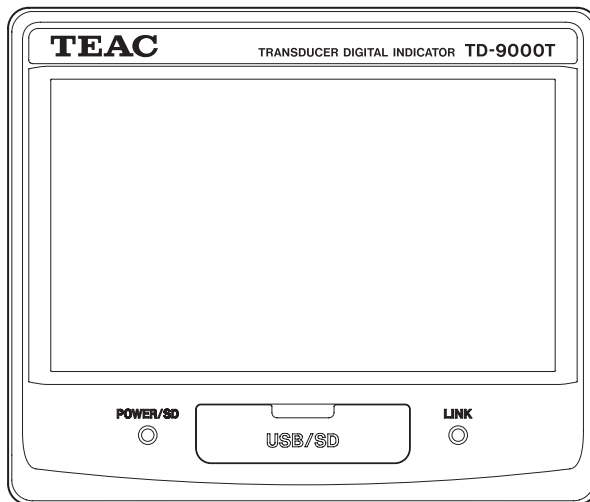

Introduction

Thank you for purchasing the TD-9000T Digital Indicator. Please read this document in its entirety before using the product to get the best performance and ensure safe and proper operation.

Features

- Five-digit digital display enables direct reading of physical quantities.
- Waveforms can be checked in real time even when they are being measured.
- Support for TEDS sensors makes calibration easy. Automatic calibration is also possible when a TEDS sensor is connected.
- An equivalent input function is included, making sensitivity adjustment without actual loads easy.
- Supports remote sense functions. Even using long cables measurement is possible without losing precision.
- Static strain measurement is possible. Identifying load cell defects and other problems through plastic deformity is easy.
- In addition to high and low limit comparison, this indicator also supports high high limit and low low limit comparison functions.
- Measurement is possible using combinations of band and five zone judgments as desired.
Each zone supports a variety of judgments, including constant comparison, sampling, peak, bottom, peak to peak, average value, maximum/minimum and inflection point.
- DIN size supports incorporation with testing devices and manufacturing equipment, for example.
- D/A output according to designated values is a standard feature.
- Product complies with RoHS.
- Waveform display function allows input signals to be checked as waveforms.
- Measurement data can be saved on SD cards and in the built-in memory of the unit.
- Linearization function improves linearity of load measurements.

SDHC Logo is a trademark of SD-3C, LLC.

TEAC is a trademark of TEAC CORPORATION, registered in the U.S. and other countries.

Other company names, product names and logos in this document are the trademarks or registered trademarks of their respective owners.

Included accessories

If anything is missing or damaged, contact us. (For contact information, see the last page.)

SENSOR connector plug	
B2CF 3.50/18/180LR SN OR BX or equivalent part	1
CONTROL connector plug	
HDCB-37P (05) connector or equivalent part	1
HDC-CTH (4-40) (10) case or equivalent part	1
Power input terminal bank cover	
(pre-installed on unit)	1

Disclaimers

Information is given about products in this manual only for the purpose of example and does not indicate any guarantees against infringements of third-party intellectual property rights and other rights related to them. TEAC Corporation will bear no responsibility for infringements on third-party intellectual property rights or their occurrence because of the use of these products.

Using SD cards

Avoid using SD cards with adapters for microSD cards and miniSD cards.

Media types

Compatible media

SD/SDHC cards

Recording capacity

2 GB – 32 GB

Recommended speed class

Class 10

Media that has been verified to operate with this system

This system uses SD/SDHC cards for recording. We provide a list of SD/SDHC cards that we have verified for operation with this system on our Information Products Division load cell website.

<https://loadcell.jp/en/>

You can also contact us. (For contact information, see the last page.)

- In this manual, SD/SDHC cards are referred to as “SD cards”.
- Prepare recording media that has been formatted by the TD-9000T (page 68).
- Do not use a computer to delete, move or otherwise alter data recorded on an SD card. Doing so could cause the TD-9000T to become unable to properly record data.

Insertion and removal

Always insert and remove SD cards when they are not being accessed.

Never remove an SD card when the unit is operating (including when recording). Doing so could cause recording to fail or recorded data to be lost, for example. Moreover, doing so could also damage the unit.

Inserting SD cards

- 1 Open the recording media slot cover on the bottom of the front of the unit.**
- 2 Push the SD card all the way into the SD card slot on the right side of the opening.**
 - The SD card has a front end that must be inserted first. Insert the card with the correct orientation.

Forcing a card into the card slot could damage this unit.

- A clicking sound can be heard when the card is pushed all the way in.

- 3 Close the recording media slot cover.**

Removing SD cards

- 1 Open the recording media slot cover.**
- 2 Push the SD card in gently.**
The SD card will come out part way.
- 3 Pull the SD card out by hand.**
- 4 Close the recording media slot cover.**

SD card write-protection switches

SD cards have write-protection switches.

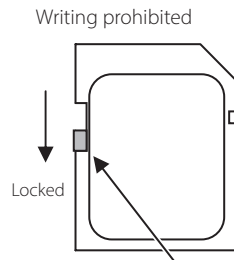

Write-protection switch
Writing data can be prohibited by moving the switch to the LOCK position.

- Slide the write-protection switch to one direction completely.

- To use an SD card for recording or to erase recording data on it or format it, unlock the write-protection.

ATTENTION

When using an SD card with a capacity of 2 GB, FAT file system restrictions limit the number of files to 127. Even when using a card with a larger capacity, we recommend keeping a maximum of about 1000 data files because processing speed becomes slower as the number of files increases (page 69).

Safety information

This document describes the safety instructions for the operation of the digital indicator. Before operating the product, read this document carefully to familiarize yourself with the unit.

 WARNING	Follow the instructions below to avoid risk of serious personal injury and death.
Never use beyond the rated specifications as there is the danger of property damage, injury, fire or electrical shock.	
Never use in flammable gaseous environments including the following locations as there is the danger of explosion. <ul style="list-style-type: none">• Locations containing corrosive or flammable gases• Locations near water, oil or subject to chemical splash	
If the product malfunctions (smells strange or becomes hot), stop using it immediately and unplug the power cord as there is danger of fire or electrical shock.	
Never attempt to disassemble the product.	
Carefully check connections and wiring before applying power.	
Be sure to ground the product (with ground resistance of 100 Ω or less).	
To allow the operator to immediately shut off the power to the product, install a switch or circuit breaker that complies with both IEC60947-1 and IEC60947-3 requirements near the product. The switch or breaker installed must also indicate that it functions to shut off the power to the unit.	
Do not allow foreign objects such as metal fragments that result from cutting panels, wires or other materials to enter this unit.	
If the unit is dropped or subject to strong impacts, it could break. If this occurs, stop using it and contact the seller from which you purchased it.	
Overvoltage category: I Pollution degree: 2	
If the unit is used in a manner not specified by the manufacturer, the protection provided by the unit may be impaired.	



CAUTION

Follow the instructions below to avoid risk of personal injury or property damage.

Disconnect the power cord when performing the following.

When wiring or connecting cables to the terminal banks for connecting the DC power supply, load cells and external inputs and outputs

Connecting the ground line

Wait for at least one minute between turning the unit on and off.

Never touch the rear panel or connectors while the product is turned on.

When connecting to a power supply, frame ground or signal input/output connector, be sure to wire them correctly after confirming the signal names and pin assignment numbers. Use shielded cables for signal input/output cables (load cell, external input/output).

Before use, fix the cables separately so that they do not hang to prevent the connectors from being pulled out and to protect the connectors from unnecessary pressure.

Conduct wiring in a place so that it will not be together or parallel with electrical wiring.

Avoid use in locations like the following.

- Near a power line
- Where a strong electric or magnetic field is present
- Where static electricity or noise, (for example, from a relay) is generated

Do not install in the following environments.

- Locations subject to temperatures exceeding the specified ranges for temperature and humidity
- Locations subject to radiant heat from heat sources
- Locations with high salt or iron content
- Locations exposed to dirt and dust
- Locations subject to direct vibration or shock
- Locations subject to severe temperature changes
- Outdoor, or locations with an altitude of higher than 2000 m
- Locations where freezing or condensation might occur

Do not operate a damaged unit.

The unit is classified as an open-type (built-in) device and must be installed inside a control panel.

If the top cover or panel faces become dirty, wipe it gently with a soft cloth that has been slightly dampened with a diluted neutral cleaning fluid and wrung out well. DO NOT use a chemically treated dust cloth, paint thinner, or other flammable solvents. Using any of them could damage the coating of the product.

If the product is used in a manner unintended by the manufacturer, the user's safety may be adversely affected.

Always attach the DC power terminal bank cover when an electric current is present.

If subject to electromagnetic waves (from transceivers, mobile phones, amateur wireless transmissions, etc.), use metal pipes for the wiring or make other countermeasures using shielding.

Model for USA

Supplier's Declaration of Conformity

Model number: TD-9000T

Trade name: TEAC

Responsible party: TEAC AMERICA, INC.

Address: 10410 Pioneer Blvd. Unit #3, Santa Fe Springs, CA 90670, U.S.A.

Telephone number: 1-323-726-0303

This device complies with Part 15 of the FCC Rules.

Operation is subject to the following two conditions: (1) this device may not cause harmful interference, and (2) this device must accept any interference received, including interference that may cause undesired operation.

Information

This equipment has been tested and found to comply with the limits for a Class A digital device, pursuant to part 15 of the FCC Rules. These limits are designed to provide reasonable protection against harmful interference when the equipment is operated in a commercial environment. This equipment generates, uses, and can radiate radio frequency energy and, if not installed and used in accordance with the instruction manual, may cause harmful interference to radio communications. Operation of this equipment in a residential area is likely to cause harmful interference in which case the user will be required to correct the interference at his own expense.

CAUTION

Changes or modifications not expressly approved by the party responsible for compliance could void the user's authority to operate the equipment.



Model for Canada

This Class A digital apparatus complies with Canadian ICES-003.

Cet appareil numérique de la classe A est conforme à la norme NMB-003 du Canada.

Model for Europe

DECLARATION OF CONFORMITY

This product complies with the European Directives request, and the other Commission Regulations.



DECLARACIÓN DE CONFORMIDAD

Este producto cumple con las exigencias de las directivas europeas y con los reglamentos de la Comisión Europea.

DÉCLARATION DE CONFORMITÉ

Ce produit est conforme aux directives européennes et aux autres réglementations de la Commission européenne.

KONFORMITÄTSERKLÄRUNG

Dieses Produkt entspricht den Anforderungen europäischer Richtlinien sowie anderen Verordnungen der Kommission.

Model for UK

This product complies with the applicable UK regulations.



WARNING

This is a Class A product. In a domestic environment, this product may cause radio interference in which case the user may be required to take adequate measures.

ATENCIÓN

Este es un producto de clase A. En un entorno no profesional, este aparato puede producir interferencias de radio, en cuyo caso el usuario será el responsable de tomar las medidas necesarias para solucionarlo.

AVERTISSEMENT

Il s'agit d'un produit de Classe A. Dans un environnement domestique, cet appareil peut provoquer des interférences radio, dans ce cas l'utilisateur peut être amené à prendre des mesures appropriées.

Warnung

Dies ist eine Einrichtung, welche die Funk-Entstörung nach Klasse A besitzt. Diese Einrichtung kann im Wohnbereich Funkstörungen verursachen; in diesem Fall kann vom Betreiber verlangt werden, angemessene Maßnahmen durchzuführen und dafür aufzukommen.

DISCLAIMER

TEAC disclaims all warranty, either expressed or implied, with respect to this product and the accompanying written materials. In no event shall TEAC be liable for any damages whatsoever (including, without limitation, damages for loss of business profits, business interruption, loss of business information or other loss) arising out of the use of or inability to use this product.

Disposing of this product

When disposing of this product, including accessories, consumable parts and related items, follow the regulations of the local, regional and national governments.

For European Customers

Disposal of electrical and electronic equipment and batteries and/or accumulators

- a) All electrical/electronic equipment and waste batteries/accumulators should be disposed of separately from the municipal waste stream via collection facilities designated by the government or local authorities.
- b) By disposing of electrical/electronic equipment and waste batteries/accumulators correctly, you will help save valuable resources and prevent any potential negative effects on human health and the environment.
- c) Improper disposal of waste electrical/electronic equipment and batteries/accumulators can have serious effects on the environment and human health because of the presence of hazardous substances in the equipment.

- d) The Waste Electrical and Electronic Equipment (WEEE) symbols, which show wheeled bins that have been crossed out, indicate that electrical/electronic equipment and batteries/accumulators must be collected and disposed of separately from household waste.



If a battery or accumulator contains more than the specified values of lead (Pb), mercury (Hg), and/or cadmium (Cd) as defined in the Battery Directive (2006/66/EC, 2013/56/EU), then the chemical symbols for those elements will be indicated beneath the WEEE symbol.



Pb, Hg, Cd

- e) Return and collection systems are available to end users. For more detailed information about the disposal of old electrical/electronic equipment and waste batteries/accumulators, please contact your city office, waste disposal service or the shop where you purchased the equipment.

Contents

Introduction	2	4. Settings	27
Features	2	4-1. Basic operation	27
Included accessories	2	4-1-1. Buttons	27
Using SD cards	3	4-1-2. Changing setting values	27
Media types	3	4-1-3. Option display	28
Media that has been verified to operate with this system	3	4-1-4. Returning to the Home Screen	28
Insertion and removal	3	4-1-5. Pop-up screens	28
Inserting SD cards	3	4-2. SENSOR settings	29
Removing SD cards	3	4-2-1. D/A converter	30
SD card write-protection switches	3	4-3. Load cell calibration	31
Safety information	4	Procedures shared by all calibration methods	32
1. Names and functions of parts	10	4-3-1. Equivalent input calibration	33
1-1. Front	10	4-3-2. Actual load calibration	35
1-2. Back	11	4-3-3. TEDS calibration	37
1-3. Home Screen	12	4-3-4. Load cell operation settings	40
1-3-1. Indicator value display	12	4-4. Displacement sensor calibration	41
1-3-2. Waveform display	13	Procedures shared by all calibration methods	42
1-3-3. Zooming the waveform display in/out	14	Locking and unlocking calibration values	42
1-4. Buttons and their functions	14	4-4-1. Equivalent input calibration	42
1-4-1. Digital zero	15	4-4-2. Actual load calibration	43
1-4-2. Measurement results display	15	4-5. Work settings	44
1-4-3. SENSOR MEMORY/WORK NUMBER setting	17	4-5-1. CONTINUOUS JUDGMENT	45
1-4-4. SD button	17	4-5-2. BAND JUDGMENT	46
1-5. Status change illustration	18	4-5-3. Zone judgment	48
1-6. Screen transition diagram	18	4-5-4. Band + Zone judgment	52
2. Installation	19	4-5-5. CURRENT BAND WAVE & MULTI-ZONE ARRANGEMENT screen	53
3. Making connections	20	4-6. Start/stop measurement	53
3-1. Connecting to the SENSOR connector	20	4-6-1. Measurement start/stop settings for zone judgment	53
3-1-1. SENSOR connector	20	4-6-2. Continuous judgment timing chart	55
3-2. Connecting a strain gauge transducer	20	4-6-3. Band judgment timing chart	55
3-2-1. About the remote sense function	20	4-6-4. Zone judgment timing chart	56
3-2-2. Notes about bridge voltage (excitation voltage)	20	5. System settings	65
3-3. Displacement sensor	21	5-1. Lock and language settings	65
3-3-1. Displacement sensor (voltage)	21	5-1-1. Lock settings	65
3-3-2. Displacement sensor (pulse)	22	5-1-2. Language setting	65
3-3-3. Displacement sensor (pulse) counting method	22	5-2. Memory and counter settings	66
3-4. D/A Converter	23	5-2-1. INTERNAL MEMORY	66
3-5. Control signal output terminals (CONTROL connector)	23	5-2-2. OK/NG COUNTERS	66
3-5-1. Connecting control output terminals	23	5-3. Various settings	67
3-5-2. Control output signals	24	5-3-1. DATE & TIME SETTING	67
3-6. Control signal input terminals (CONTROL connector)	24	5-3-2. TRIGGER OUTPUT	68
3-6-1. Connecting control input terminals	25	5-3-3. RESET TO FACTORY SETTINGS	68
3-6-2. Control input signals	25	5-3-4. SD CARD	68
3-7. RS-232C connector	26	5-3-5. SERIAL COMM.	71
3-8. Connecting the DC power supply input terminals	26	5-3-6. TEST & INFO	71
		5-3-7. FIELD NETWORK	71

6. Communication functions	72
6-1. Serial communication	72
6-1-1. Settings	72
6-1-2. Command lists	73
6-1-3. Communication protocol	78
6-1-4. Unique communication protocols	80
6-1-5. Timing	88
7. Setting lists	89
7-1. Setting menu list	89
7-1-1. SYSTEM	89
7-1-2. SENSOR	89
7-1-3. WORK	90
7-2. Setting value list	91
7-2-1. SETTINGS	91
7-2-2. CALIB. & SYSTEM	91
7-2-3. SYSTEM	91
7-2-4. SENSOR	92
7-2-5. WORK	95
8. Error message list	97
9. Warranty explanation	98
10. Specifications	99
11. External drawings	100

1. Names and functions of parts

1-1. Front

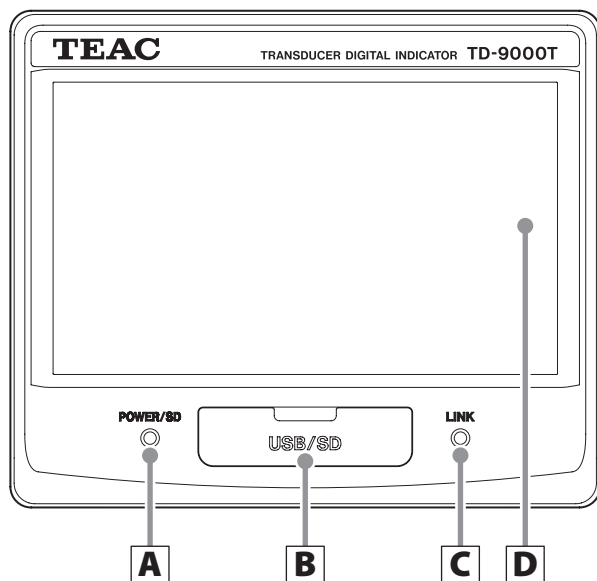

A POWER/SD indicator

This lights blue when the unit is on.
It lights magenta when an SD card is being accessed.

B Recording media slot cover

Open the cover to reveal the USB port (left) and SD card slot (right) inside.

ATTENTION

Do not use a USB hub when connecting the USB port on this unit and a computer. Connect them directly.

C LINK indicator

This shows the status of the communication option.
For details, see the operation manual of the communication option.

D Display

This shows indicator and setting values.

NOTE

This display is made with extremely high precision and has at least 99.99% effective pixels. Rarely, some pixels might not light or stay lit, but this is not a malfunction.

1-2. Back

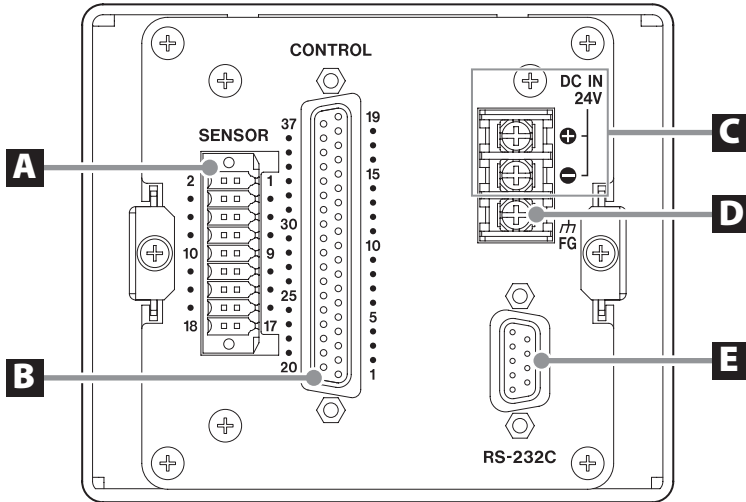

A SENSOR connector

Insert the included sensor connector plug here.

B CONTROL connector

C DC power supply input terminals

Connect a DC power supply.
The voltage range is DC 24 V \pm 10%.

D FG (frame grounding) terminal

Frame grounding terminal for DC power supply.

⚠ Always be sure to connect the frame grounding terminal.

E RS-232C connector

1. Names and functions of parts

1-3. Home Screen

When the unit is turned on, the screen last open when it was turned off reopens (indicator value or waveform screen).

1-3-1. Indicator value display

Indicator value display screen example

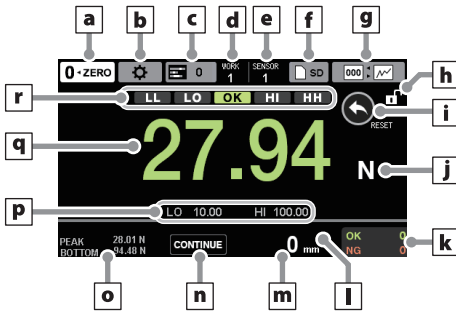

a ZERO (digital zero) button

This forcefully sets the indicator value to 0 (Digital zero function) (page 15).

b Setting button (*)

Touch to open the SETTINGS screen (page 27).

c Measurement result display button

Touch to show measurement results (page 15).

d Work number

This shows the currently selected work number.

e Sensor number

This shows the currently selected sensor number.

f SD card button

Screenshots and measurement results can be saved on SD cards.

g Screen switching button

Touch to switch between indicator value and waveform display.

h Panel lock indicator

This shows the "Prevent touchscreen operation" status set with the control signal input terminal (CONTROL connector).

: Touchscreen locked

: Touchscreen unlocked

i Reset button

This clears hold display.

j Load unit

The load unit shown is set by the Unit shown item on the load cell screen (page 40).

k Judgment statistics

This shows the number of OK and other judgment results.

l Displacement judgment

This shows the judgment result.

HI

This appears when the hold value exceeds the high limit value.

OK

This appears when the hold value is no less than the low limit value and no more than the high limit value.

LO

This appears when the hold value is below the low limit value.

HI/L

This appears when multiple zones are designated and HI and LO are mixed.

--

This appears when judgment (hold) was not possible.

m Displacement indicator value

The number of digits shown is the same as the display value on the displacement sensor calibration screen.

- Touch this during waveform display to open the DISPLACE.SENSOR screen.

n Status

CONTINUE: Continuous judgment

WAIT TRG: Waiting to start measurement

REC: Measuring

STOP: Measuring stopped (holding)

o Load peak and bottom values

This shows the peak and bottom values of load input.

Touch to reset these values.

p Management values

This shows the high limit, low limit, high high limit and low low limit setting values for continuous judgment.

- The high high limit and low low limit are shown when HHLL is enabled (page 45).

NOTE

During measurement (REC), judgment is conducted using the management values set in the work.

q Load indicator value

This shows the current indicator value. This can also show the zone judgment hold value after measurement (page 57).

The number of digits shown is the same as set for the rated capacity value.

- Touch this during waveform display to open the LOAD CELL screen.

r Load judgment

The judgment result appears highlighted.

HH

This appears when the hold value exceeds the high high limit value.

HI

This appears when the hold value exceeds the high limit value.

OK

This appears when the hold value is no less than the low limit value and no more than the high limit value.

LO

This appears when the hold value is below the low limit value.

LL

This appears when the hold value is below the low low limit value.

- HI and LO will be shown at the same time if they both occur in multi-zone judgment.

t SCALE button

Touch to zoom in/out or move the waveform display (page 14).

u Waveform

This shows the measurement results as a waveform.

Values between the low limit and the high limit are shown in white.

Values above the high limit or below the low limit are shown in red.

v Load judgment

The judgment result appears highlighted.

HI

This appears when the hold value exceeds the high limit value.

OK

This appears when the hold value is no less than the low limit value and no more than the high limit value.

LO

This appears when the hold value is below the low limit value.

H/L

This appears when multiple zones are designated and HI and LO are mixed.

--

This appears when judgment (hold) was not possible.

w Starting point

The Y axis is 0 by default, but it will change if the waveform is moved up or down (page 14).

The X axis is fixed to 0.

x Maximum display value

If load and displacement are set for the Y axis, the maximum displacement display value will be shown below the maximum load display value.

Example of screen during band measurement

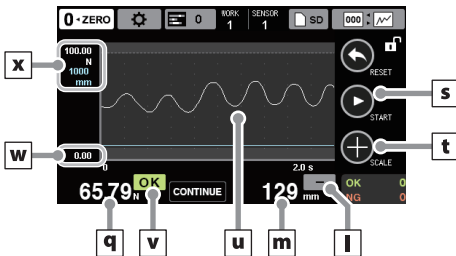

s START/STOP button

Touch to manually start and stop measurement.

Example of screen during multi-zone judgment

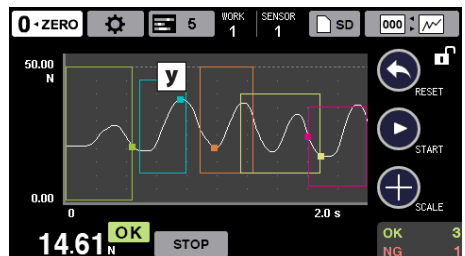

1. Names and functions of parts

y Zone ranges

These are shown by rectangles of different colors.

- The mark shows the hold position for the zone of the corresponding color.

1-3-2-1. X and Y axis default values

The X axis is set using "X AXIS FULL SCALE" on the SENSOR screen (page 29).

The Y axis is 110% of the "MAX. DISP. VALUE" on the load cell screen (page 40).

- The value set with "X AXIS FULL SCALE" is the basis for the measurement range. Set the full-scale range before setting band measurement and multi-zone ranges.

1-3-3. Zooming the waveform display in/out

On the waveform display screen, touch the \oplus button to open the GRAPH SCALE CHANGE SCREEN.

- This only increases/decreases the scale of the load waveform.

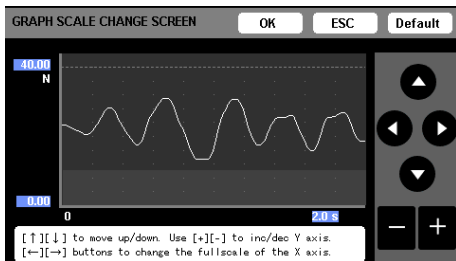

Change the maximum value of the Y axis.



Change the full-scale value of the X axis.



Change the minimum value of the Y axis.

NOTE

Setting a negative value will move the starting point up, enabling negative value waveforms to be shown.

OK

Confirm the settings and return to the waveform display screen.

ESC

Cancel the settings and return to the waveform display screen.

Default

Restore the default settings for waveform display.

1-4. Buttons and their functions

Button	Function
	Digital zero (page 15).
	Open SETTINGS screen (page 27).
	Show measurement results (page 15).
	Open SENSOR MEMORY/WORK NUMBER screen (page 17)
	Save screenshots and measurement results on SD cards. The icon shows the SD card status (page 17).
	Touch to switch between indicator value and waveform display.
	Reset the hold status. Touch during measurement to cancel measurement.
	Manually start and stop measurement.
	Zoom the waveform display in/out (page 14).
	Touch a load indicator value on the waveform display to open the LOAD CELL screen (page 40).
	Touch a displacement indicator value on the waveform display to open the DISPLACE. SENSOR screen (page 41)
	Reset the OK and NG counters.
	Reset peak and bottom values.
	Set the comparison values for continuous judgment (page 45).

1-4-1. Digital zero

The current indicator value for load or displacement becomes zero.

Touch the ZERO button on the screen to show options for the sensor to execute digital zero, and select the desired one (page 31).

When using a control signal input terminal (CONTROL connector), turn "Digital zero" on for load and turn "Zero balance displacement" on for displacement.

- The range for setting the digital zero is set with "D/Z LIMIT SETTING".
- Calibrating or turning the unit off will clear the digital zero.
- If a digital offset is set, after digital zero is executed, the load value shown will have the set digital offset value subtracted from 0 (page 41).

1-4-2. Measurement results display

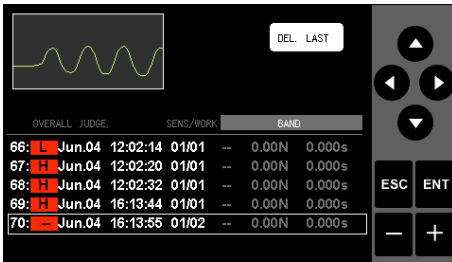

ATTENTION

Data saved in the built-in memory are shown. See "5-2. Memory and counter settings" on page 66 for details about data saving settings.

1-4-2-1. Operation when the measurement result list is open

DEL LAST

This deletes the newest measured data. Deleting measurement data does not affect judgment statistics.



Use to scroll up and down on the screen to show measurement results.



Use to scroll left and right on the screen to show measurement results.

ESC

Touch to return to the previous screen.

ENT

Show the waveform of the selected position.



Use to zoom the waveform display in and out.

Displayed items

Page 1 (initial page)

Number, overall judgment, date and time, sensor number/work number

Page 2 and later

Band judgment cases

Overall judgment, judgment value (Y axis: load/displacement), judgment position (X axis: time/displacement)

Multi-zone judgment cases

The set zones are shown in the following format.

Overall judgment, judgment value (Y axis: load/displacement), judgment position (X axis: time/displacement)



1-4-2-2. Opening measurement waveforms

When the measurement result list is shown, use the ▲ and ▼ buttons to select the data, and touch the ENT button.

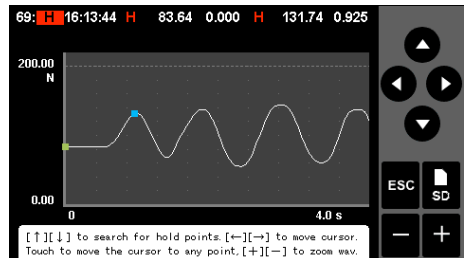

Touch the SD button to save a screenshot to the SD card.

1. Names and functions of parts

1-4-2-3. Operation during waveform display

Showing multi-zone judgment hold positions

Touch the ▲ button to show the cursor at the zone hold position. Use the ▲ and ▼ buttons to change the zone shown.

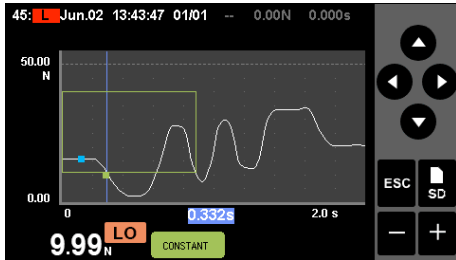

Zone display colors

1: olive, 2: cyan, 3: orange, 4: light yellow, 5: pink

Moving the cursor

Touch the graph to show the cursor at that position.

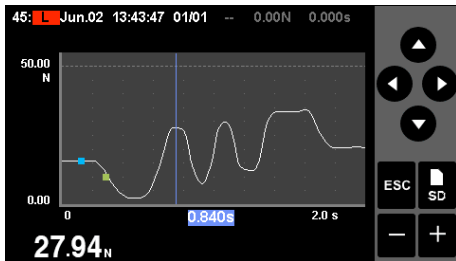

Use the ◀ and ▶ buttons to adjust the cursor position precisely.

- The point of intersection between the cursor and the hold position or other measurement waveform position could be slightly off due to calculation rounding errors, for example.

1-4-2-4. Saved data overview

Rather than saving all sampled data as is, this unit saves data at intervals.

2240 data points will be saved in the X axis full scale range.

For example, if the X axis is time, and X axis full scale is 800 ms, saving will occur at 0.4ms intervals (see the table below). For example, if the X axis is displacement and X axis full scale is 10,000, saving will occur at intervals of 5.

In the following example of data saving, the sampling frequency is 25 kHz, the X axis is time and X axis full scale is 800 ms.

- ○: Sampling data
- ●: Saved data

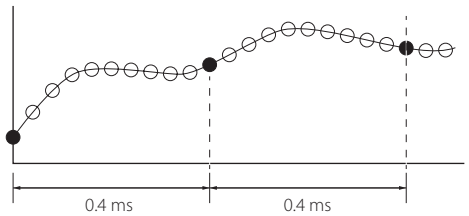

X axis full scale settings and saving intervals

X axis	Set time	Measurement time	Saving interval
Time	80 ms*	89.6 ms	0.04 ms
	170 ms*	179.2 ms	0.08 ms
	400 ms	448 ms	0.2 ms
	800 ms	896 ms	0.4 ms
	2.0 s	2.24 s	1 ms
	4.0 s	4.032 s	2 ms
	10.0 s	10.304 s	4.6 ms
	30.0 s	30.016 s	13.4 ms
	60.0 s	60.032 s	26.8 ms
Displacement	90.0 s	90.048 s	40.2 ms
	2000	2240	1.0
	4000	4480	2.0
	6000	6720	3.0
	8000	8960	4.0
	10000	11200	5.0
	15000	15680	7.0
20000	20160	9.0	
30000	31360	14.0	

1. Names and functions of parts

The previous waveforms are shown using the interval data. If a hold position is not at an interval data point, the hold position data will be shown in place of the sample data immediately preceding it.

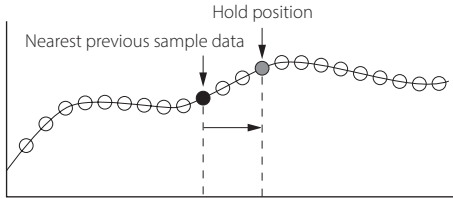

When measuring with the X axis as displacement, values are recorded only when displacement increases.

1-4-3. SENSOR MEMORY/WORK NUMBER setting

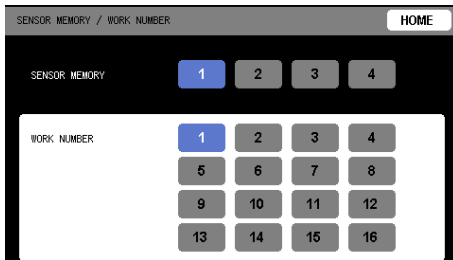

Touch the Setting button (✳) to change the sensor memory and work number without opening the settings screen.

ATTENTION

If work switching is set to external input, work numbers cannot be changed.

1-4-4. SD button

Touch the SD button to open the following screen.

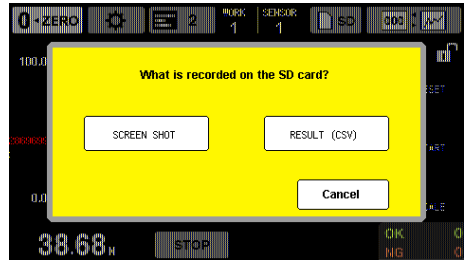

SCREEN SHOT

This saves the Home Screen display on the SD card in bit-map format.

The file will be saved with a name that starts with "td9kt_screen_".

RESULT (CSV)

The data shown when stopped will be saved to the SD card.

NOTE

The following icons show the SD card status.

Button	Status
	An SD card is loaded.
	The unit has detected that the number of files saved on the SD card has exceeded the maximum value that was set. When the maximum number has been exceeded, files will be overwritten from the oldest first.
	This shows that some error has occurred with the SD card and writing could not occur normally. If it always appears this way, for example, format the SD card or replace it with another one.
	The SD card is write-protected. Data cannot be saved.
	No SD card has been inserted in the unit or it is not recognized.

ATTENTION

Be aware that the SD card error status (red or yellow) will be updated when writing occurs.

1. Names and functions of parts

1-5. Status change illustration

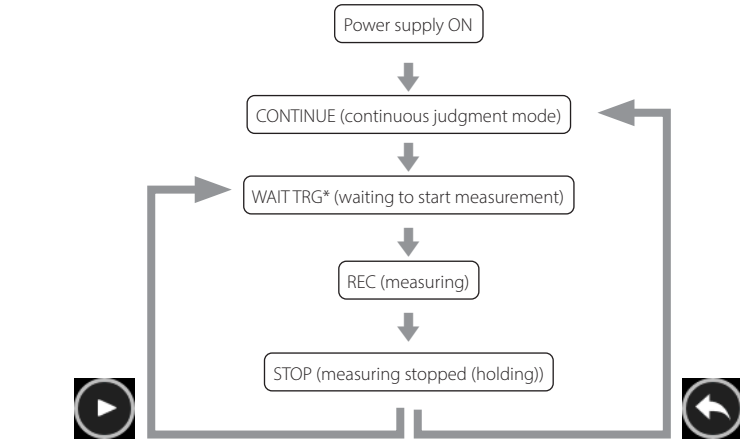

Start/stop measurement ON or touch START button

Clear results ON or touch Reset button

*Will skip if no trigger is set.

1-6. Screen transition diagram



2. Installation

Follow these procedures to install the TD-9000T in a control panel.

- 1** Open a hole in the panel in accordance with this dimensional drawing of the panel installation opening.

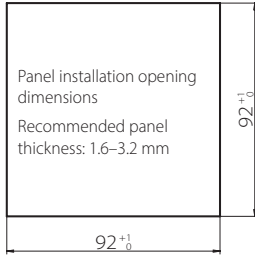

- 2** Remove the screws in two locations. Then, remove the left and right guide rails.

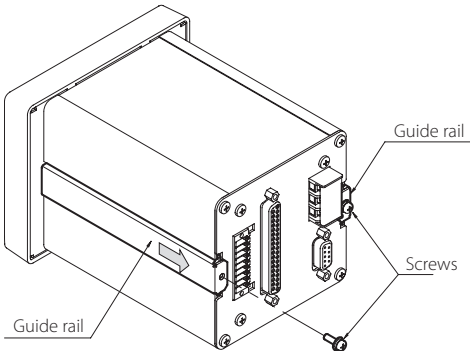

- 3** Insert the TD-9000T through the front of the panel.

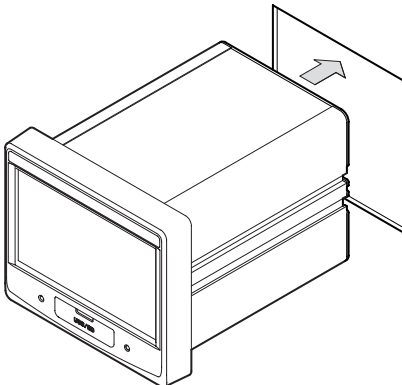

- 4** From the back, attach the guide rails removed in step 2 and secure them using screws in two places.

(Recommended tightening torque: 0.5 N·m ≈ 5.1 kgf·cm)

- Do not use any screws other than those included with the TD-9000T.

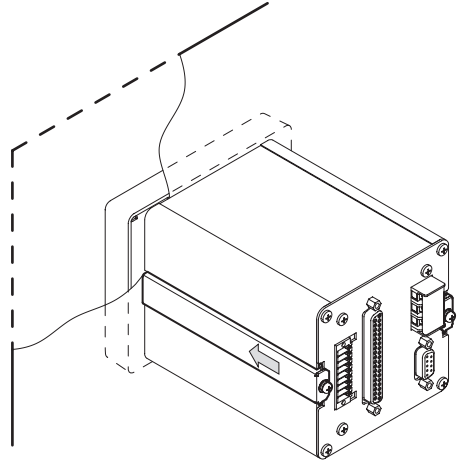

3. Making connections

3-1. Connecting to the SENSOR connector

A 2-piece type connector is used. Insert the included sensor connector plug into the SENSOR connector. When wiring the sensor connector plug, press the button for each pin while inserting the wire.

ATTENTION

Do not connect any connector plug other than one included because doing so could make it unsafe.

3-1-1. SENSOR connector

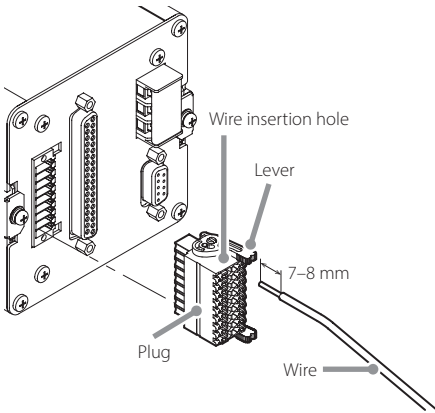

1 Remove 7-8 mm of the covering from the wire being connected, and twist it so that the tip does not come apart.

Suitable wiring is 0.14-1.5 mm² (26-16 AWG).

2 While pressing the buttons attached to each pin, insert the wires into the holes so that the tips do not come apart.

3 Pull the wire gently to confirm that it is securely clamped into the hole.

4 After the wires have been connected, press the plug into the indicator until the levers on both its sides lock.

3-2. Connecting a strain gauge transducer

3-2-1. About the remote sense function

Set the remote sense settings before connecting the sensor (page 33).

By default, this is set to "UNUSED (4-wire)".

The 6-wire format (remote sense format) is a superior connection method that compensates for reduced voltages due to cable length and voltage changes due to temperature changes, for example.

In systems installed outdoors and other situations where temperature changes are expected, as well as in cases when general precision is desired, for example, we recommend using the six-wire format for remote sense.

ATTENTION

- When using the 6-wire format (remote sense format), before connecting a sensor, always set "REMOTE SENSING" to "USED (6-wire)".
- Use "UNUSED (4-wire)" with 4-wire format.
- Incorrect connections or settings could cause damage to sensors.

3-2-2. Notes about bridge voltage (excitation voltage)

As a reference for setting the bridge voltage, consider that the output from the sensor should be increased, and set the maximum voltage in a range that does not exceed the maximum safe excitation voltage on the sensor test report.

A sensor could be damaged if this is set to a value that exceeds its maximum safe excitation voltage.

ATTENTION

- If the maximum safe excitation voltage is less than 5 V, set the bridge voltage to 2.5 V before connecting.
- In TEDS calibration, when TEDS data is read, if the bridge voltage setting is greater than the maximum safe excitation voltage recorded in the TEDS memory, the bridge voltage will be changed to a value that is no more than the maximum safe excitation voltage.

NOTE

The default value is 2.5 V (page 33).

3. Making connections

Connecting TEDS sensors and 4-wire sensors

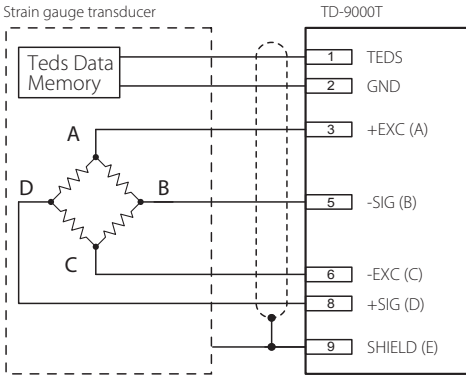

The wire colors are those that we use in the strain gauge transducers that we make.

Terminal number	Signal	Wire color
1	TEDS	Orange
2	GND	Green
3	+EXC (A)	Red
4	+SENS (F)	–
5	–SIG (B)	Black
6	–EXC (C)	Blue
7	–SENS(G)	–
8	+SIG (D)	White
9	SHIELD (E)	Yellow

Connecting using 6-wire sensors

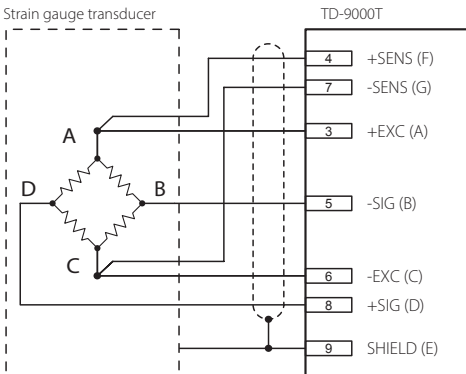

3-3. Displacement sensor

Power is only output (voltage or pulse) for the displacement sensor selected with INPUT MODE on the DISPLACE. SENSOR settings screen (page 41).

+12V is output when voltage is selected, and +5V is output when pulse is selected.

3-3-1. Displacement sensor (voltage)

The +12V power supply of pin 10 can be used as a 250mA (maximum) power supply for a displacement sensor (voltage).

Connection example

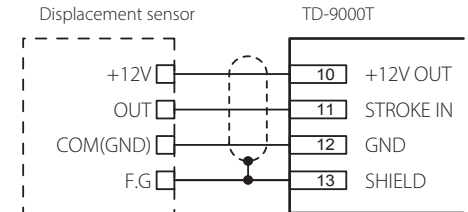

Terminal number	Signal
10	+12V OUT
11	STROKE IN
12	GND
13	SHIELD

Usable sensor characteristics

- Output between +SIG and –SIG: ± 3.2 mV/V or less
- Voltage (current) between +EXC and –EXC: 10V DC, 5V DC or 2.5V DC $\pm 10\%$ (30mA maximum current)

ATTENTION

Do not connect sensors that do not meet the rated output (output between +SIG and –SIG) and the maximum safe excitation voltage (voltage between +EXC and –EXC) specifications.

NOTE

If not using the TEDS function, terminals 1 and 2 can be left open.

3. Making connections

3-3-2. Displacement sensor (pulse)

Connect a differential square wave output type displacement sensor.

This unit internally converts differential output signals from sensors (RS422 level) to TTL level.

- The +5V power supply of pin 17 can be used as a 500mA (maximum) power supply for a displacement sensor (pulse).

Connection example

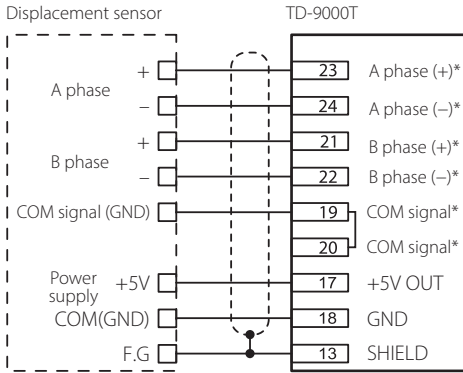

*CONTROL connector 19-24 (see page 24)

Terminal number	Signal
13	SHIELD
17	+5V OUT
18	GND
19*	COM signal
20*	COM signal
21*	Differential pulse displacement sensor B phase +
22*	Differential pulse displacement sensor B phase -
23*	Differential pulse displacement sensor A phase +
24*	Differential pulse displacement sensor A phase -

ATTENTION

Connect the COM signal in order to conform to the reference for the signal.

Failure to connect this could result in breakdown or malfunction.

3-3-3. Displacement sensor (pulse) counting method

The TD-9000T has modes that support A phase only and AB phase (2-phase) output signals from displacement sensors (pulse).

The count value changes as shown below for A phase only and AB phase output.

NOTE

HI: Input is OFF

LO: Input is ON

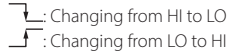

When output phase A

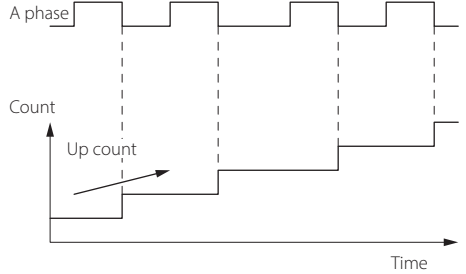

Up counts occur when the A phase input pulse signal is ON (at the falling edge).

When output phase AB

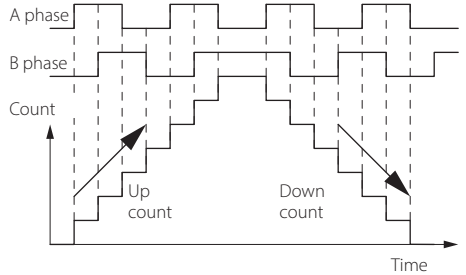

Count operations

A phase input	B phase input	Count operation
	LO	Up count
	HI	
HI		
LO		Down count
	HI	
	LO	
LO		Down count
HI		

Counts occur at both the rising and falling edges of A and B phase input pulses.

See "Count operations" above for whether the count is up or down.

3-4. D/A Converter

For voltage output, connect an external device with a load resistance of 2 k Ω or more to V-OUT and COM.

For current output, connect an external device with a load resistance, including cable wiring resistance, of 350 Ω or less to I-OUT and COM.

- Voltage output or current output can be used. They cannot output both at the same time. Set voltage or current in the D/A output setting of the sensor screen (page 29).

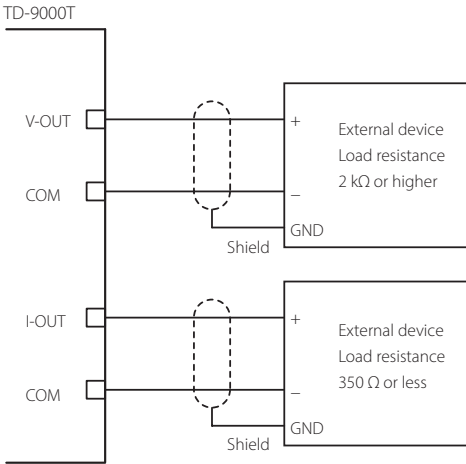

Terminal number	Signal	Explanation
14	V-OUT	D/A voltage output
15	I-OUT	D/A current output
16	COM	D/A output common terminal

- The D/A output is isolated from this unit's circuits.

3-5. Control signal output terminals (CONTROL connector)

Terminal number	Signal
1	COM signal
2	COM signal
3	Unit error
4	Load cell error
5	Measurement complete
6	Trigger output 2
7	Trigger output 1
8	Band judgment output (load HI)
9	Band judgment output (load OK)
10	Band judgment output (load LO)
11	Judgment output (displacement HI)
12	Judgment output (displacement OK)
13	Judgment output (displacement LO)
14	Judgment output (load HH)
15	Judgment output (load HI)
16	Judgment output (load OK)
17	Judgment output (load LO)
18	Judgment output (load LL)

- The judgment output is isolated from this unit's circuits by a photocoupler.

3-5-1. Connecting control output terminals

Open collector output (NPN, current sync)
20mA/30V maximum collector current

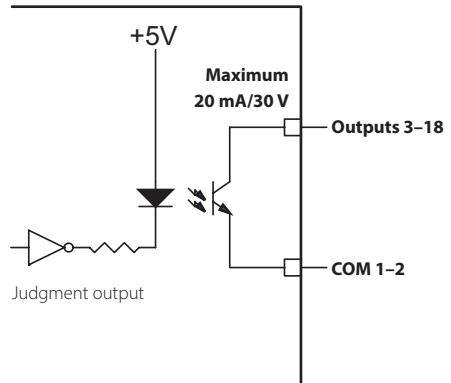

- For the operation of each signal, see "4-6. Start/stop measurement" on page 53.

3. Making connections

3-5-2. Control output signals

Unit error

This becomes ON if the load cell input exceeds the $\pm 3.2\text{mV/V}$ range.

Load cell error

This becomes ON if the load cell input exceeds the maximum display value.

Measurement complete

This becomes ON when a measurement is completed and the next measurement is possible.

Band judgment output

This outputs band judgments.

Judgment output

This outputs continuous judgments and multi-zone judgments.

3-6. Control signal input terminals (CONTROL connector)

Terminal number	Signal
19	COM signal
20	COM signal
21	Differential pulse displacement sensor B phase +
22	Differential pulse displacement sensor B phase -
23	Differential pulse displacement sensor A phase +
24	Differential pulse displacement sensor A phase -
25	Force backlight lighting
26	Prevent touchscreen operation
27	Force reset
28	Switch work 8
29	Switch work 4
30	Switch work 2
31	Switch work 1
32	Switch zone
33	Clear results (reset measurement results)
34	Enable/disable judgment output
35	Start/stop measurement
36	Zero balance displacement
37	Digital zero

- The control input signal is isolated from the unit's circuits by a photocoupler.
- Signals are input to each terminal by shorting and opening them with 19 and 20 COM.
A current of about 20 mA results from shorting.
When using a transistor, select one with a resistance of at least 10 Ω and elements that allow the flow of at least 40 mA when on.
- You can confirm the status of input and output signals on the screen shown in "5-3-6. TEST & INFO" on page 71.

ATTENTION

Conducting a forced reset when the unit is writing data to a USB flash drive or SD card could cause data loss.

3-6-1. Connecting control input terminals

Signals are input with the external input circuit when shorted or opened between any control input terminal and the COM terminal.

Shorts occur from both contact and non-contact (transistor, TTL open collector).

TD-9000T

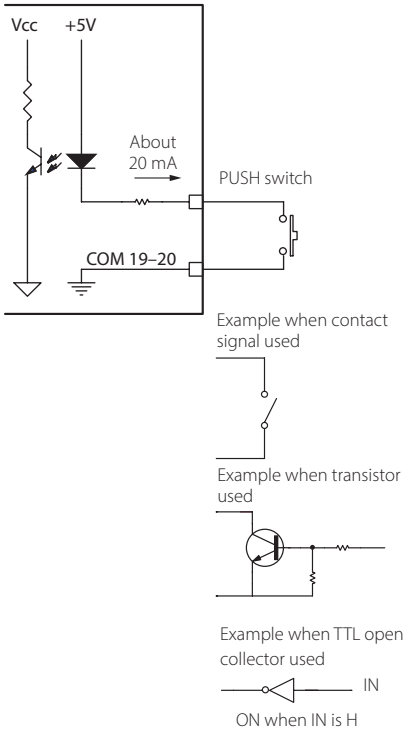

- When external contact is ON, about 20 mA flows. When using a transistor, for example, select one with a resistance of at least 10 V and elements that allow a flow of at least 40 mA when on.
- Do not apply voltage from an external source.

3-6-2. Control input signals

Differential pulse displacement sensor A phase, B phase

Connect a differential square wave output type displacement sensor (page 22).

Force backlight lighting

Enable the backlight while this is ON.

Prevent touchscreen operation

Disable touchscreen operation while this is ON.

Force reset

Setting this to ON restarts the unit.

Switch work

These can be used to specify the work number when the "WORK SWITCHING" setting on the WORK settings screen is "EXT. INPUT".

WORK SWITCHING 1 is the LSB and WORK SWITCHING 8 is the MSB.

WORK NUMBER	WORK SWITCHING			
	8	4	2	1
1	OFF	OFF	OFF	OFF
2	OFF	OFF	OFF	ON
3	OFF	OFF	ON	OFF
4	OFF	OFF	ON	ON
5	OFF	ON	OFF	OFF
6	OFF	ON	OFF	ON
7	OFF	ON	ON	OFF
8	OFF	ON	ON	ON
9	ON	OFF	OFF	OFF
10	ON	OFF	OFF	ON
11	ON	OFF	ON	OFF
12	ON	OFF	ON	ON
13	ON	ON	OFF	OFF
14	ON	ON	OFF	ON
15	ON	ON	ON	OFF
16	ON	ON	ON	ON

Switch zone

This is enabled when ZONE SWITCHING is set to EXT. INPUT (page 57). While ON, it becomes zone. Switching is limited to zones that have zone judgment enabled (page 53).

Clear results (reset measurement results)

Setting this to ON clears judgment results.

All judgment output is turned OFF, and continuous judgment (CONTINUE) starts.

Enable/disable judgment output

Setting this to ON disables all judgment output.

3. Making connections

Start/stop measurement

When "MEASURE. START. COND." or "MEASURE. STOP. COND." is set to "EXT. SIGNAL" on the WORK settings screen, this controls starting and stopping measurement.

Select the control method with EXT. START/STOP (page 67).

When set to "EDGE", measurement will start or stop when it switches from OFF to ON.

When set to "LEVEL", measurement will start when it switches to ON and stop when it switches to OFF.

Zero balance displacement

Setting this to ON zero-balances the displacement sensor.

Digital zero

Setting this to ON sets the digital zero (page 15).

3-7. RS-232C connector

Terminal number	Signal
1	---
2	TXD
3	RXD
4	---
5	GND
6	---
7	---
8	---
9	---

ATTENTION

The connector on the unit is a socket (female).

- Screws: No.4-40 UNC
- When using a commercially-available cable, be careful to confirm the connector shape.
- When using this connector to connect this unit with a computer or sequencer, use an RS-232C (9-pin) cable with straight wires.
- This connector and the USB port on the front of the unit cannot be used together. When using this connector, set "PORT SELECTION" to Rear D-SUB ("D-SUB") in the "SERIAL COMM" settings (page 72).

3-8. Connecting the DC power supply input terminals

The DC power supply input voltage should be $24\text{ V} \pm 10\%$. Use a power supply cord that is $0.517\text{--}2.081\text{ mm}^2$ (20–14 AWG). When connecting to the terminal bank, use a solderless terminal (M3, width of 6 mm or less).

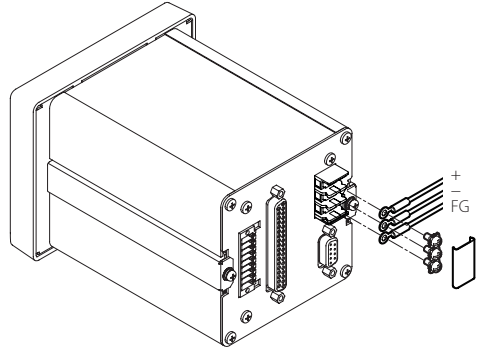

ATTENTION

- If using the unit as a CE compliant product, the power cord must be no more than 3m long.
- Allow the unit to warm up for at least five minutes after supplying power to it.
- The recommended tightening torque for terminals is 0.5 N·m (5.1 kgf·cm).

⚠ Always attach the cover to the power supply input terminal bank. Failure to do so could result in fire, electric shock or malfunction.

⚠ Use a power supply that conforms to a limited energy circuit as specified in IEC61010-1. Failure to do so could cause fire or other hazards.

4-1. Basic operation

Touch the  button on the HOME Screen to show the SETTINGS screen.

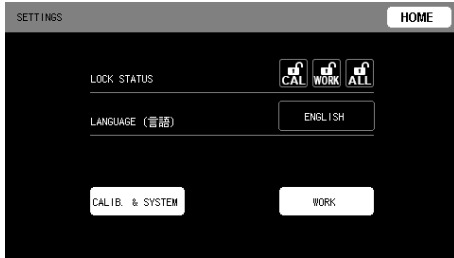

ATTENTION!

Use a finger to gently touch the screen. Do not use hard or sharp objects to touch the screen. Doing so could break the screen.

Do not touch the screen in multiple locations at the same time. It might not be able to recognize the touches correctly.

4-1-1. Buttons

Buttons include selection buttons and execution buttons.

Selection buttons

These show selectable options and the selected value. Selectable option buttons are shown as gray rectangles. The selected value is shown as a blue rectangle. This is the item selected from among the options.

Display example



Execution buttons

Touch these buttons to execute the actions shown on them.

White rectangular buttons move between screens.

HOME opens the Homes Screen.

ESC returns to the previous screen open before the current one.

OK confirms the setting and returns to the previous screen.

Display example



Use CALIB. & SYSTEM to make calibration and system settings. WORK opens work settings.

Display example



Touch buttons with white rectangular borders to execute the action shown on them.

EXECUTE executes the items shown next to the button.

Display example

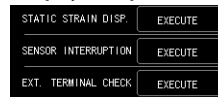

Setting value display buttons

White-bordered rectangular buttons to the right of setting items are setting value buttons. Touch one to open its settings screen.

Display example



4-1-2. Changing setting values

Setting values are shown inside white rectangles.

To change one, touch the white rectangle with a finger, for example, to open its settings screen.

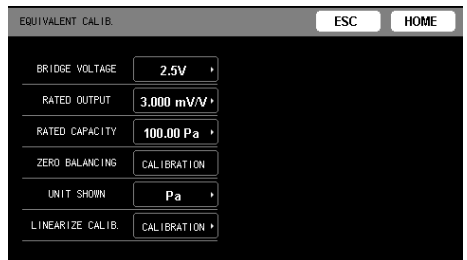

4. Settings

4-1-2-1. Inputting numerical setting values

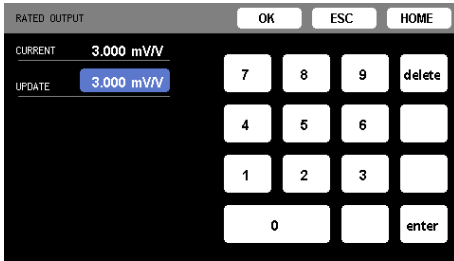

Touch a number button with a finger, for example, to input numerical values.

Touch OK to set the input value.

Touch delete to clear the input value.

Changing the decimal point position in load and displacement display

The decimal point position in load and displacement display is linked to the decimal point positions of the rated capacity values and display values on the Equivalent Input Calibration and Actual Load Calibration screens of each sensor. Input the number of digits to be shown for rated capacity values or display values. To not show any decimal point, input the decimal point at the end of the value and touch "OK" or "enter".

4-1-3. Option display

Selectable option buttons are shown as gray rectangles, and the selected value is shown as a blue rectangle.

Touch an option with a finger, for example, turning its background color blue and changing the selected item.

Touch OK to set the selected value.

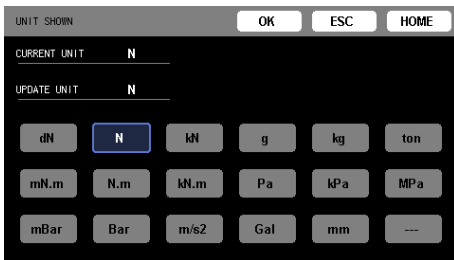

4-1-4. Returning to the Home Screen

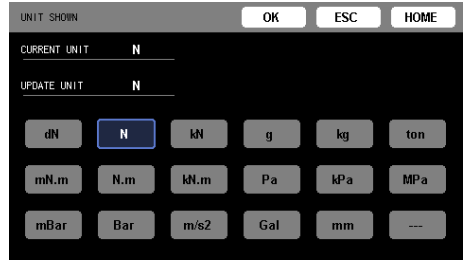

Touch the HOME button at the top right of the window to return to the Home Screen.

IMPORTANT

Always return to the Home Screen to make the unit record setting changes to the nonvolatile memory.

The settings will not be retained if the unit is turned off before returning to the Home Screen.

4-1-5. Pop-up screens

Error

Display example

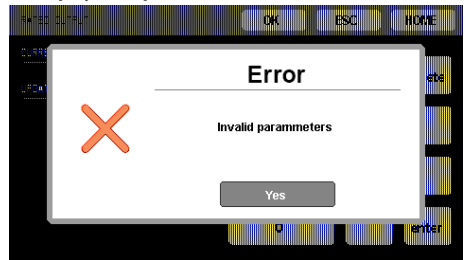

This appears when an invalid value has been set in a settings menu, for example.

Warning

Display example



Settings in menus that require warnings are shown when, for example, other settings must also be changed.

Information

Display example

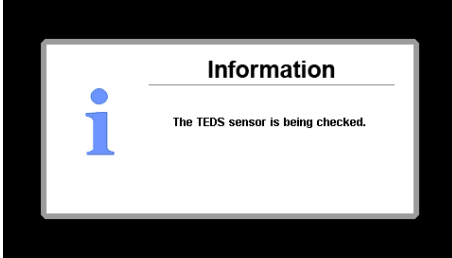

Confirmation

Display example

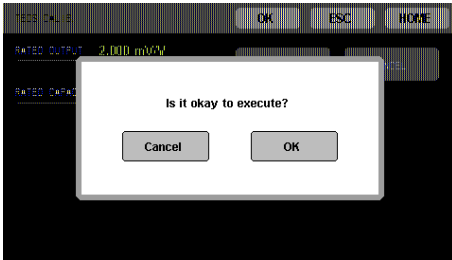

Users are asked to reconfirm before restoring the unit to factory default settings and conducting other processes that cannot be undone.

4-2. SENSOR settings

To open the SENSOR screen, touch the buttons in the following order on the Home Screen.

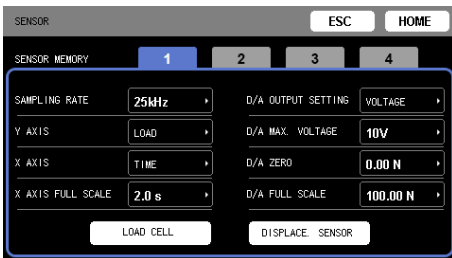

SENSOR MEMORY

This unit can save 4 sets of settings for connected sensors.

ATTENTION

Changing the sensor memory could change the decimal point positions of the parameters saved in the works depending on the calibration values.

SAMPLING RATE

This sets the sampling frequency.

Y AXIS

This sets the signal shown for the Y axis in waveform display. Select either "LOAD" or "LOAD & DISPLACE."

X AXIS

This sets the signal shown for the X axis in waveform display. Select either "TIME" or "DISPLACE."

X AXIS FULL SCALE

This sets the width of the X axis in waveform display.

- 80 ms and 170 ms cannot be selected when the sampling frequency is set to 5 kHz.

D/A OUTPUT SETTING

This sets whether D/A output is voltage output or current output.

D/A MAX. VOLTAGE

Voltage setting (limiter)

- The output has an extended range of about 10% more than the set value. The output voltage range is the same in the negative direction. For example, when set to 5 V, the D/A output voltage range will be about -5.5 V to $+5.5$ V, and $+5$ V will be output when the D/A zero and D/A full scale setting values are added.

D/A ZERO

Set the indicator value to output for D/A Zero (0V voltage or 4mA current).

D/A FULL SCALE

With the D/A ZERO value as the reference, set the span for the indicator values output to D/A.

When the value is the D/A ZERO and D/A FULL SCALE setting values added, the voltage of the D/A MAX. VOLTAGE setting value (20 mA when in electrical current mode) is output.

LOAD CELL

For information about load cell settings, see "4-3-4. Load cell operation settings" on page 40 and "4-3. Load cell calibration" on page 31.

DISPLACE. SENSOR

For information about displacement sensor settings, see "4-4. Displacement sensor calibration" on page 41.

4. Settings

4-2-1. D/A converter

The D/A converter allows for analog output that corresponds to the unit indicator value.

The D/A output circuit is isolated from the main unit circuit.

The analog output range is either 0–±10V voltage output or 4–20mA current output. Set the maximum voltage output between ±1 V and ±10 V in 1V steps using the D/A max. voltage setting.

Analog output from zero (0 V, 4 mA) to full scale (±10 V, 20 mA) can be achieved according to the digital values set using D/A Zero and D/A full scale settings.

The zero point and full scale cannot be changed separately for current output and voltage output.

D/A output is synchronized to the sampling frequency.

The following are examples of when “D/A MAX. VOLTAGE” is set to 10V.

Setting example 1

D/A Zero	000.00
D/A full scale	100.00
Indicator value	D/A output
100.00	10V(20mA)
0.00	0V(4mA)
-100.00	-10V(--mA)

Setting example 2

D/A Zero	020.00
D/A full scale	100.00
Indicator value	D/A output
120.00	10V(20mA)
20.00	0V(4mA)
-80.00	-10V(--mA)

Setting example 3

D/A Zero	020.00
D/A full scale	-100.00
Indicator value	D/A output
120.00	-10V(--mA)
20.00	0V(4mA)
-80.00	10V(20mA)

Setting example 4

D/A Zero	-010.00
D/A full scale	020.00
Indicator value	D/A output
10.00	10V(20mA)
-10.00	0V(4mA)
-30.00	-10V(--mA)

ATTENTION

If calibration is conducted, when the rated capacity is confirmed, it will be set as the D/A full scale value.

4-3. Load cell calibration

Connecting the unit with a strain gauge transducer and setting how the indicator values will be shown is called "calibration". The following three calibration methods can be used with the unit.

1. Equivalent input calibration

This calibration method does not depend on actual loads. It only requires the input of the strain gauge transducer rated output (mV/V) and the rated capacity (value you want shown). Use this to calibrate easily when an actual load cannot be applied.

Examples:

Load	100kN rated capacity, 2.001mV/V rated output
Pressure	10.00MPa rated capacity, 2.002mV/V rated output
Torque	15.00N-m rated capacity, 2.502mV/V rated output

In this manner, by recording values from test reports, the gain can be determined automatically and shown.

2. Actual Load Calibration

This calibration method measures the values of actual loads on the strain gauge transducer.

By applying an actual load that is as close as possible to the maximum measured value, calibration with less error is possible.

3. TEDS calibration

This calibration method uses the strain gauge transducer rated output (mV/V) and rated capacity that are recorded in TEDS memory.

Note, however, that equipment with TEDS memory includes both 1kbit and 4kbit devices, but the unit only supports 4kbit.

Sensor check before calibrating

After connecting a sensor and providing power, calibration is not possible if the indicator value is unstable or an error appears. If this occurs, enable static strain display and check the indicator value. In this mode, the sensor output itself is shown as a strain amount unit (μST), so input between 0 and ± 3.2 mV/V will be shown as a value from 0 to ± 6400 .

NOTE

To show static strain, touch the buttons in the following order.

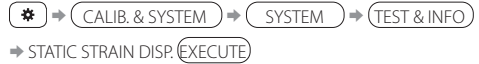

Overview of zero balancing and digital zero functions

1. Zero balancing value definition

This is the value for which zero balancing is conducted during the sensor calibration procedures in this chapter.

2. Digital zero (D/Z) value definition

The Digital zero (D/Z) function can be used to show zero separately from the zero balancing value.

Depending on the setting, the zero value might not be retained when the power is restarted.

Name	When power restarted
Digital zero (D/Z) value	The set zero value is reset, and the zero balancing value is shown.
Zero balancing value	The set zero value is retained.

A strain gauge transducer should have written test results with contents such as the following.

Rated Capacity:	load, barometric pressure, etc. (with units of kN, Mpa, etc.)
Rated Output:	voltage (unit: mV/V)
Linearity:	%R.O.
Hysteresis:	%R.O.
Safe excitation voltage (maximum):	V (bridge voltage)
Input Terminal Resistance:	Ω
Output Terminal Resistance:	Ω
Zero Balance:	%R.O.

- The data necessary for equivalent input calibration are rated capacity and rated output.
- Some of this data is written to the internal memory of the TEDS sensor.

4. Settings

Procedures shared by all calibration methods

The three calibration methods are equivalent input calibration, actual load calibration and TEDS calibration. All the calibration methods have the same procedures before and after calibration.

An overview of the calibration procedures is shown below.

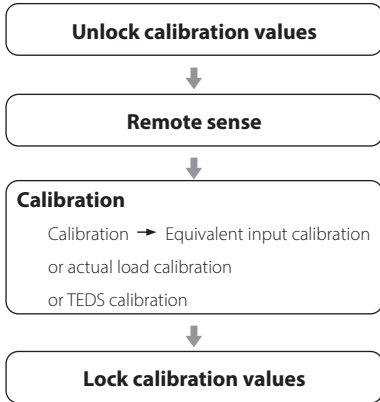

Following an explanation of the procedures to be conducted before and after calibration are explanations of the procedures for equivalent input calibration, actual load calibration and TEDS calibration.

ATTENTION

When calibration is conducted, the D/A converter setting will be initialized automatically according to the calibration value.

Locking and unlocking calibration values

Usually, the unit is used with CALIBRATION LOCK set to ON. This must be set to OFF before calibration. After calibration, set it to ON again.

NOTE

To open the LOAD CELL screen, touch the buttons in the following order on the Home Screen.



- 1 Touch the CALIBRATION LOCK setting value button on the LOAD CELL screen.

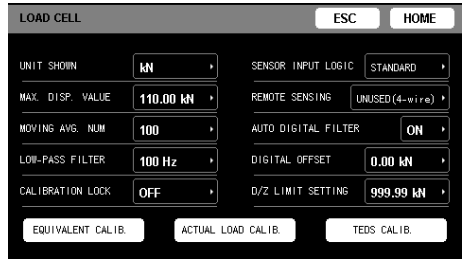

- 2 Select OFF or ON.



- 3 Touch the OK button to confirm the setting.

ATTENTION

In order to prevent accidental changes to the calibration value, set CALIBRATION LOCK to ON after calibration.

NOTE

See "7-2. Setting value list" on page 91 for information about settings that cannot be changed when CALIBRATION LOCK is ON.

Remote sense

Before connecting a sensor, check its specifications and set remote sense on the LOAD CELL screen.

Set to "USED (6-wire)" when using 6-wire format (remote sense format). Set to "UNUSED (4-wire)" when using 4-wire format.

4-3-1. Equivalent input calibration

This method determines the calibration value by recording rated output and rated capacity values from a test report.

Use this to calibrate easily when an actual load cannot be applied.

An overview of the equivalent input calibration procedures is shown below.

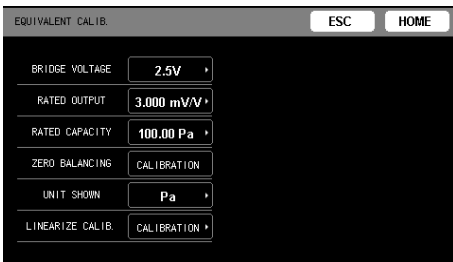
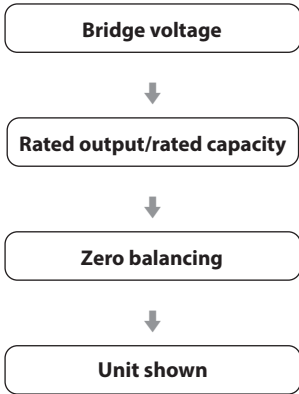

4-3-1-1. BRIDGE VOLTAGE

Select the bridge voltage to supply to the strain gauge transducer.

- As a reference for setting the bridge voltage, consider that the output from the sensor should be increased, and set the maximum voltage in a range that does not exceed the maximum safe excitation voltage on the sensor test report.

ATTENTION

A sensor could be damaged if this is set to a value that exceeds its maximum safe excitation voltage.

NOTE

- The default value is 2.5 V.
- In TEDS calibration, when TEDS data is read, if the bridge voltage setting is greater than the maximum safe excitation voltage recorded in the TEDS memory, the bridge voltage will be changed to a value less than the maximum safe excitation voltage.

4-3-1-2. RATED OUTPUT

Input range: 0.100–3.200 mV/V

Set the rated output of the strain gauge transducer being used.

4-3-1-3. RATED CAPACITY

Set the rated capacity of the strain gauge transducer being used.

NOTE

The decimal point position set here will be used as the indicator value decimal point position.

4-3-1-4. ZERO BALANCING

With no load on the sensor, touch the EXECUTE button.

- If a calibration error appears, conduct countermeasures according to the error message, and redo calibration.

4-3-1-5. UNIT SHOWN

Select the unit that corresponds to the indicator value from the list, and touch the OK button.

NOTE

The unit shown is next to the indicator value, but it has no effect on internal calculations.

For example, the calibration value will not change even if the unit shown is changed from "N" to "kN".

4. Settings

4-3-1-6. LINEARIZE CALIB.

The linearity of load measurements is improved by increasing the calibration points.

After equivalent input calibration, input the linearization calibration.

1 Touch the ON button to enable linearization calibration.

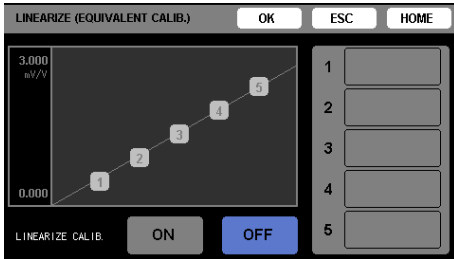

2 Touch the number of the linearization point (calibration point) to input on the right side of the screen.

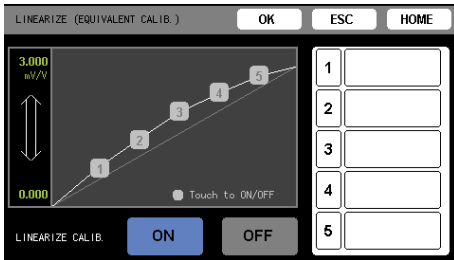

3 Input the calibration values (output and load values) and touch the OK button.

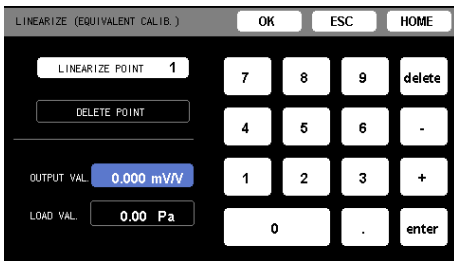

The "LOAD VAL." cannot be set to a value that would be 5% or more relative to the straight-line (reference line) that connects the no load and rated load outputs.

ATTENTION

The following conditions must always be met.

- $0 < \text{output value} < \text{rated output}$
- Output value of lower-numbered calibration point < output value of higher-numbered calibration point

4 Confirm the input values. Then, touch ESC to return to the previous screen.

5 Repeat steps 2-4 to input necessary calibration values, and touch the OK button.

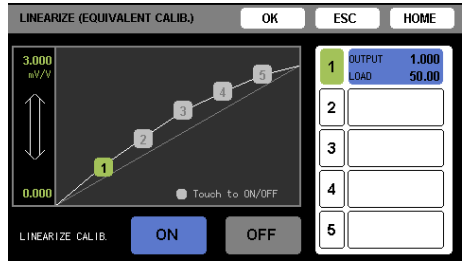

NOTE

- The calibration waveform shown on the LINEARIZE (EQUIVALENT CALIB.) screen is an illustration, not the actual calibration curve.
- After linearization calibration value input, touch the OFF button to disable linearization calibration. Since input calibration values are saved, touching the ON button will enable linearization calibration.
- To disable a specific calibration point, touch its number so that its background color disappears. In the illustration below, calibration point 2 is disabled.

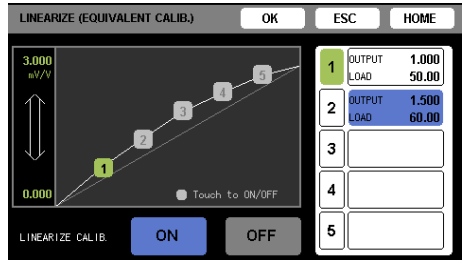

- The possible range of linearization is shown by the dashed lines in the illustration below.

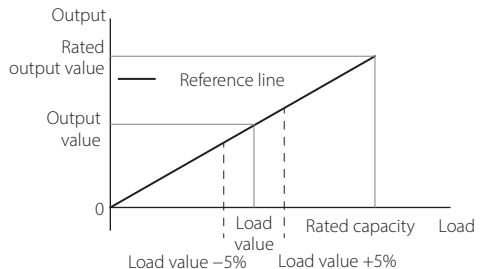

4-3-2. Actual load calibration

Calibrate by applying an actual load to the sensor.

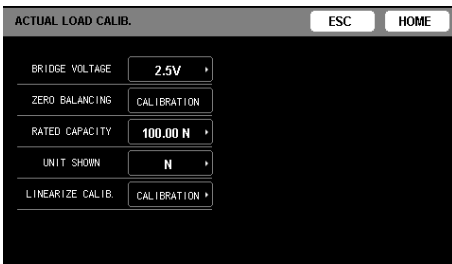
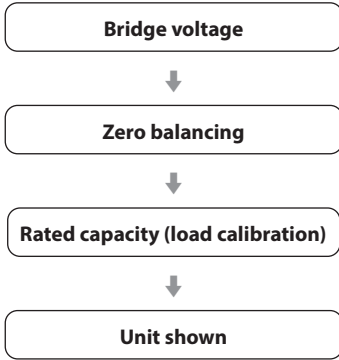

4-3-2-1. BRIDGE VOLTAGE

Select the bridge voltage to supply to the strain gauge transducer.

- As a reference for setting the bridge voltage, consider that the output from the sensor should be increased, and set the maximum voltage in a range that does not exceed the maximum safe excitation voltage on the sensor test report.

ATTENTION

If you set a value that exceeds the sensor's maximum safe excitation voltage, the sensor could be damaged.

NOTE

- The default value is 2.5 V.
- In TEDS calibration, when TEDS data is read, if the bridge voltage setting is greater than the maximum safe excitation voltage recorded in the TEDS memory, the bridge voltage will be changed to a value less than the maximum safe excitation voltage.

4-3-2-2. ZERO BALANCING

With no load on the sensor, touch the CALIBRATION button.

- If a calibration error appears, conduct countermeasures according to the error message, and redo calibration.

4-3-2-3. RATED CAPACITY (load calibration)

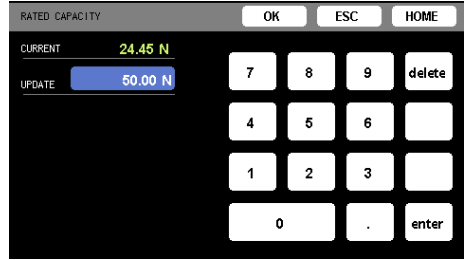

1 Set the rated capacity and touch the enter button.

2 With an actual load applied to the sensor, touch the OK button.

The measurement value is saved the moment the OK button is touched.

- If a calibration error appears, conduct countermeasures according to the error message, and redo calibration.

NOTE

The decimal point position set for the rated capacity will be used as the decimal point position for the indicator value.

4-3-2-4. UNIT SHOWN

Select the unit that corresponds to the indicator value from the list, and touch the OK button.

NOTE

The unit shown is next to the indicator value, but it has no effect on internal calculations.

For example, the calibration value will not change even if the unit shown is changed from "N" to "kN".

4. Settings

4-3-2-5. LINEARIZE CALIB.

The linearity of load measurements is improved by increasing the calibration points.

Do this after actual load calibration.

- 1 Touch the ON button to enable linearization calibration.

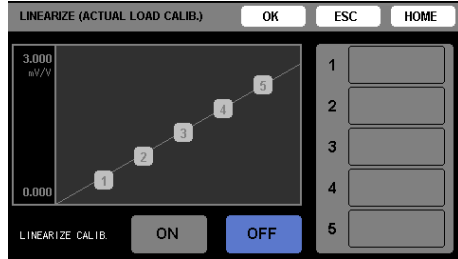

- 2 Touch the number of linearization point (calibration point) to input on the right side of the screen.

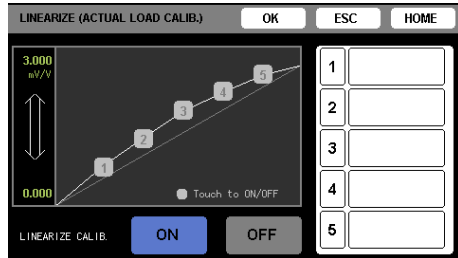

- 3 After inputting the load applied to the sensor in the "OUTPUT VAL." field, apply the load, and touch the enter button.

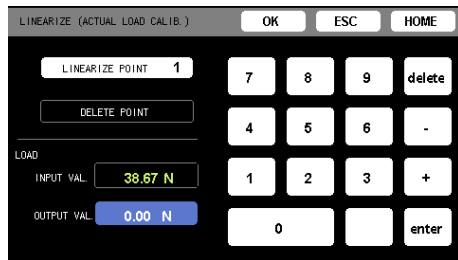

The "OUTPUT VAL." cannot be set to a value that would be 5% or more relative to the straight-line (reference line) that connects the no load and rated load outputs.

ATTENTION

The following conditions must always be met.

- $0 < \text{output value} < \text{rated capacity}$
- Output value of lower-numbered calibration point < output value of higher-numbered calibration point

- 4 Confirm the input value. Then, touch ESC to return to the previous screen.
- 5 Repeat steps 2-4 to input necessary calibration values, and touch the OK button.

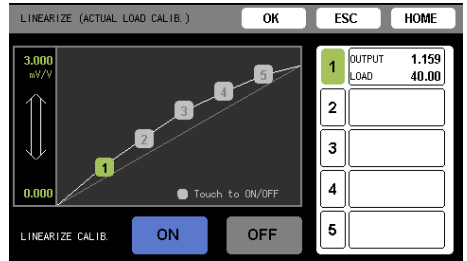

NOTE

- The calibration waveform shown on the LINEARIZE (ACTUAL LOAD CALIB.) screen is an illustration, not the actual calibration curve.
- After linearization calibration value input, touch the OFF button to disable linearization calibration. Since input calibration values are saved, touching the ON button will enable linearization calibration.
- To disable a specific calibration point, touch its number so that its background color disappears. In the illustration below, calibration point 2 is disabled.

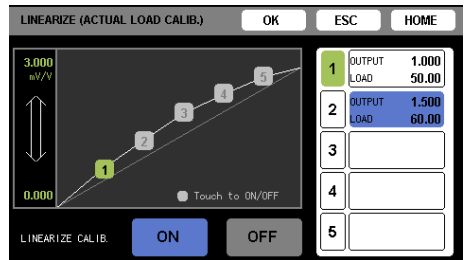

- The possible range of linearization is shown by the dashed lines in the illustration below.

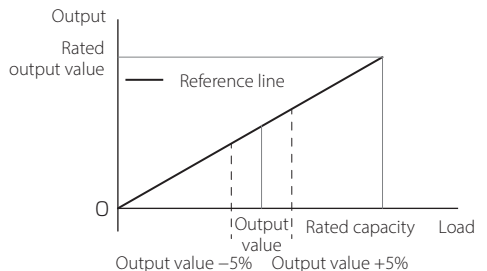

4-3-3. TEDS calibration

A TEDS sensor has calibration information, including rated output and rated capacity, stored in its memory. TEDS calibration reads this calibration information to automatically record calibration values.

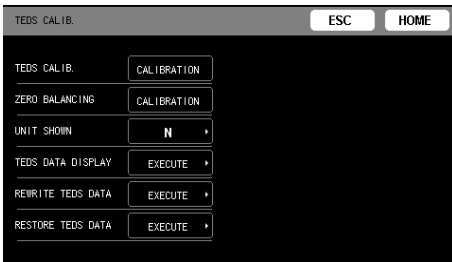
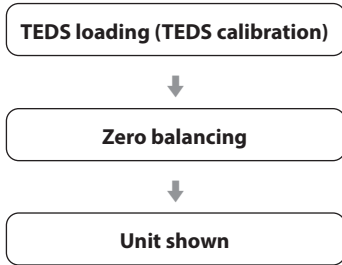

4-3-3-1. TEDS

By connecting a sensor that supports IEEE1451.4 Transducer Electronic Data Sheets (TEDS) to the unit, the rated output stored in the sensor can be loaded and this can be applied to calibration of the indicator with this function.

In addition, the value calibrated by the unit itself can be loaded to the TEDS sensor and its original value can be restored. These functions are supported by TEDS sensors that comply with the standard shown in the table below.

Note, however that equipment with TEDS memory includes both 1kbit and 4kbit devices, but the unit only supports 4kbit.

TEDS standard			
IEEE 1451.4 (V0.9)	IEEE1451.4 (V1.0)		
	Template ID		
	Bridge Sensors (33)	Strain Gauge (35)	Other
-	✓✓	✓	-

- ✓✓ TEDS calibration, TEDS data writing and TEDS data restoration supported
- ✓ TEDS calibration supported
- Not supported

4. Settings

4-3-3-2. TEDS loading

After loading the TEDS data, the rated output/rated capacity is shown.

Rated capacity digit shown during TEDS calibration

TEDS sensor Rated capacity value	Unit	Indicator value
1	N, kN	01.000
2	N, kN	02.000
3	N, kN	03.000
4	N, kN	04.000
5	N, kN	05.000
10	N, kN	010.00
20	N, kN	020.00
30	N, kN	030.00
40	N, kN	040.00
50	N, kN	050.00
100	N, kN	0100.0
200	N, kN	0200.0
300	N, kN	0300.0
400	N, kN	0400.0
500	N, kN	0500.0

NOTE

- TEDS data is automatically loaded when the power is turned on.
- After TEDS data is loaded once, it will not be loaded automatically again until a different TEDS sensor is connected. If you want to load it again, manually execute "TEDS CALIB".
- The decimal point position for the rated capacity will be used as the decimal point position for the indicator value.
- The maximum display value (Max. disp. value) is set as 110% of the rated capacity.

ATTENTION

The bridge voltage will be set to a value that is less than the maximum safe excitation voltage stored in the TEDS memory.

4-3-3-3. ZERO BALANING

With no load on the sensor, touch the EXECUTE button.

- If a calibration error appears, conduct countermeasures according to the error message, and redo calibration.

4-3-3-4. UNIT SHOWN

Select the unit that corresponds to the indicator value from the list, and touch the OK button.

NOTE

- The unit shown is next to the indicator value, but it has no effect on internal calculations. For example, the calibration value will not change even if the unit shown is changed from "N" to "kN".
- If a sensor with TEDS built in is connected, the read unit will be set.

4-3-3-5. TEDS DATA DISPLAY

Select TEDS DATA DISPLAY to show the following items.

MANUFACTURER
MODEL NUMBER
VERSION
SERIAL NUMBER
RATED OUTPUT
RATED CAPACITY
UNIT SHOWN
SENSOR IMPEDANCE
MAX. EXCITATION LEVEL
CAL. DATE

TEDS DATA DISPLAY		OK	ESC	HOME
MANUFACTURER	:	TEAC		
MODEL NUMBER	:	3196		
VERSION	:	A65		
SERIAL NUMBER	:	356		
RATED OUTPUT	:	1.500 mV/V		
RATED CAPACITY	:	200.0		
UNIT SHOWN	:	N		
SENSOR IMPEDANCE	:	360.0 Ω		
MAX. EXCITATION LEVEL	:	6.0V		
CAL. DATE	:	2014/ 6/ 3		

Touch the ESC button to exit TEDS data display mode.

4-3-3-6. REWRITE TEDS DATA

The current calibration values (rated output and rated capacity) and calibration date will be written to the TEDS memory. The indicator unit will not be written.

1 Input "9015" and touch the enter button.

NOTE

- This value must be input to prevent accidental data change.
- Touch the ESC button to cancel and exit setting mode.

2 Input the calibration date, and touch the enter button. When "Is it okay to execute?" appears, touch the OK button.

While the calibration value is being written, "Executing" appears.

When "Executing" disappears, touch the ESC button to exit setting mode.

4-3-3-7. RESTORE TEDS DATA

Use this to restore the factory default calibration value of a sensor to which data was written using the REWRITE TEDS DATA procedures above.

ATTENTION

If a TEDS sensor has never had its data replaced, trying to restore TEDS data to it will result in an error because there is no data to restore.

1 Input "9015".

NOTE

- This value must be input to prevent accidental data change.
- Touch the ESC button to cancel and exit setting mode.

2 Touch the enter button. "Executing" will appear while the unit is restoring data from the TEDS memory.

When loading the TEDS memory restoration data completes, the rated output (mV/V) and rated capacity are shown so the values can be checked.

NOTE

Touch the ESC button to cancel and exit setting mode.

3 Touch the EXECUTE button to restore the data from the TEDS memory. "Executing" appears while this occurs.

4. Settings

4-3-4. Load cell operation settings

To open the LOAD CELL screen, touch the buttons in the following order on the Home Screen.

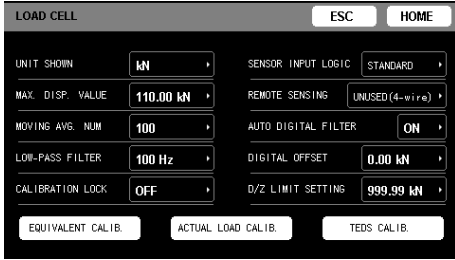

UNIT SHOWN

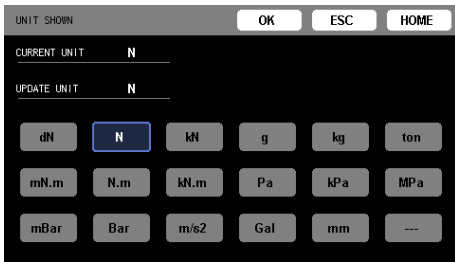

Select the indicator value unit.

Select the unit that corresponds to the indicator value.

NOTE

The unit shown is next to the indicator value, but it has no effect on internal calculations.

For example, the calibration value will not change even if the unit shown is changed from "N" to "kN".

MAX. DISP. VALUE

Set the highest displayed value.

The default value is set at 110% of the rated capacity.

If this value is exceeded, "+FULL" or "-FULL" will appear in a pop-up message.

ATTENTION

The range that can be set for MAX. DISP. VALUE is 0–32000.

Display example

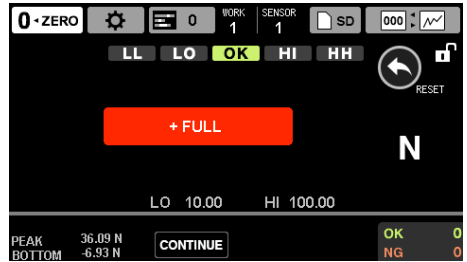

MOVING AVG. NUM.

Set the moving average number for the measured data. If zero is set, moving average will not be used.

- This will affect the display and judgment of continuous judgment mode, but the effect will not be applied to hold and judgment values.

LOW-PASS FILTER

Set the low pass filter cutoff frequency (Hz).



NOTE

When set to "OFF", only the AD converter anti-aliasing function is enabled, affecting sampling frequencies to the high limit of the range.

CALIBRATION LOCK

When "ON", calibration values cannot be changed.

- Keep this "ON" normally so that values are not changed unintentionally.

SENSOR INPUT LOGIC

The sensor input logic can be reversed artificially.

Normally, "STANDARD" should be used.

NOTE

"REVERSED" does not electrically reverse the input.

After changing this setting, always redo zero.

REMOTE SENSING

Whether or not to use remote sense must be set before connecting a sensor.

ATTENTION

Incorrect connections or settings could cause damage to sensors.

AUTO DIGITAL FILTER

When the input signal is stable, the unit can temporarily set the filter's moving average number to 1024, reducing indicator value unsteadiness.

This function can be disabled by setting it to OFF.

- This will affect the display and judgment of continuous judgment mode, but the effect will not be applied to hold and judgment values.

DIGITAL OFFSET

The set value is subtracted from the measured value.

- When the digital zero function is executed, the value shown is 0 minus the digital offset setting value.

D/Z LIMIT SETTING

Set the range for digital zero capture. (The setting value unit is the same as for the indicator value.)

ATTENTION

If the current sensor input value exceeds the D/Z LIMIT SETTING value, "The Digital Zero Limit is being exceeded." appears and the indicator value does not become zero.

Equivalent input calibration, actual load calibration and TEDS calibration setting methods are explained in "4-3. Load cell calibration" on page 31.

4-4. Displacement sensor calibration

To open the DISPLACE. SENSOR screen, touch the buttons in the following order on the Home Screen.

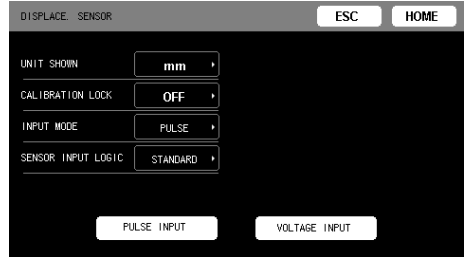

UNIT SHOWN

This sets the unit shown for displacement.

CALIBRATION LOCK

When "ON", calibration values cannot be changed.

- Keep this "ON" normally so that values are not changed unintentionally.

INPUT MODE

This sets the displacement sensor output signal.

SENSOR INPUT LOGIC

The sensor input logic can be reversed artificially. Normally, "STANDARD" should be used.

Illustration of displacement sensor calibration

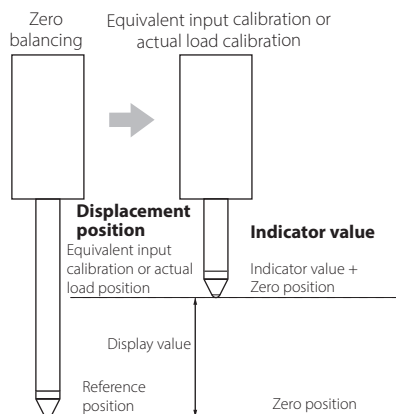

The display value and zero position are shown according to the value set on the settings screen.

4. Settings

Procedures shared by all calibration methods

The calibration methods are equivalent input calibration and actual load calibration. All the calibration methods have the same procedures before and after calibration.

An overview of the calibration procedures is shown below.

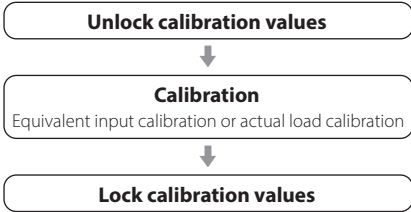

Following an explanation of the procedures to be conducted before and after calibration are explanations of the procedures for equivalent input calibration and actual load calibration.

Locking and unlocking calibration values

Usually, the unit is used with CALIBRATION LOCK set to ON. This must be set to OFF before calibration. After calibration, set it to ON again.

- 1 Touch the CALIBRATION LOCK setting value button on the DISPLACE. SENSOR screen.

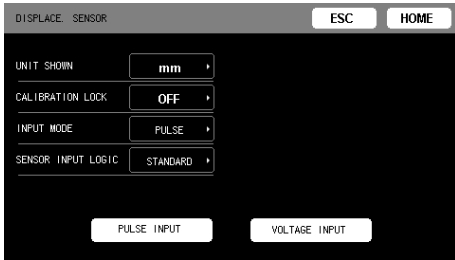

- 2 Select OFF or ON.



- 3 Touch the OK button to confirm the setting.

4-4-1. Equivalent input calibration



This method determines the calibration value by recording rated output and rated capacity values from a test report. Use this to calibrate easily when an actual load cannot be applied.

An overview of the equivalent input calibration procedures is shown below.

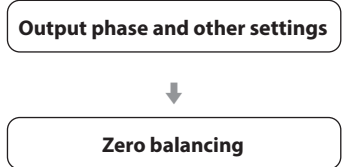

Output phase and other settings

Set items other than ZERO BALANCING.

4-4-1-1. Pulse output



OUTPUT PHASE (AB, A)

This sets the displacement sensor output.

COUNT NUMBER

DISPLAY VALUE

Set these according to the specifications of the sensor.

Calculate the resolution using the following formula.

Resolution = Display value/Count number

Setting examples

Unit shown: mm

Resolution (μm)	Display value (mm)	Count number
0.5	0.5	1000
1	1.0	
2	2.0	
5	5.0	
10.0	10.0	

ZERO POSITION

This sets the amount of displacement of the position recorded with zero balancing.

MOVING AVG. NUM.

Set the moving average number for the measured data.

4-4-1-2. Voltage output

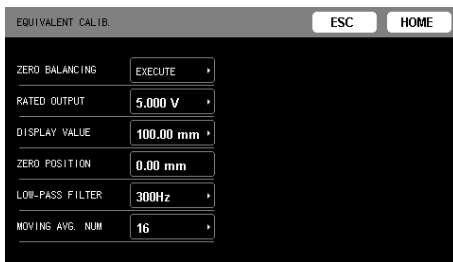

RATED OUTPUT

DISPLAY VALUE

Input the rated output (voltage) and display value from the test report of the connected displacement sensor.

ZERO POSITION

This sets the amount of displacement of the position recorded with zero balancing.

LOW-PASS FILTER

Set the low pass filter cutoff frequency (Hz).

MOVING AVG. NUM.

Set the moving average number for the measured data. If zero is set, moving average will not be used.

Zero balancing

Move the displacement sensor to the reference position, and touch the Zero balancing button. The current position of the displacement sensor is saved as the zero point.

- The displacement amount of the reference position is set as the zero position

4-4-2. Actual load calibration

Calibrate by applying an actual load to the sensor.

An overview of the calibration procedures is shown below.

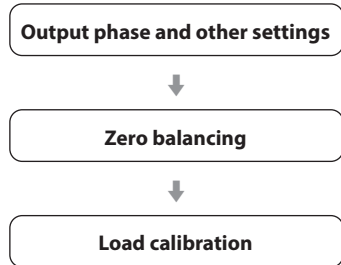

Output phase and other settings

Set items other than ZERO BALANCING and DISPLAY VALUE.

4-4-2-1. Pulse output



OUTPUT PHASE (AB, A)

This sets the displacement sensor output.

ZERO POSITION

This sets the amount of displacement of the position recorded with zero balancing.

MOVING AVG. NUM.

Set the moving average number for the measured data. If zero is set, moving average will not be used.

4. Settings

4-4-2-2. Voltage output



ZERO POSITION

This sets the amount of displacement of the position recorded with zero balancing.

LOW-PASS FILTER

Set the low pass filter cutoff frequency (Hz).

MOVING AVG. NUM.

Set the moving average number for the measured data.

Zero balancing

Move the displacement sensor to the reference position, and touch the Zero balancing button. The current position of the displacement sensor is saved as the zero point.

- The displacement amount of the reference position is set as the zero position

Load calibration

Touch the setting value display button next to DISPLAY VALUE to open the settings screen.

After moving the displacement sensor from the reference position by just the distance set as the "DISPLAY VALUE", input the display value, and touch the enter or OK button.

The position of the displacement sensor when the enter or OK button is touched is saved as the actual load position.

4-5. Work settings

After installing this unit, set the following items when using it the first time.

See "4. Settings" on page 27 for information about settings.

- Clock settings (page 67)
- Connected sensor settings (page 29)
- SD card settings (when saving data to an SD card) (page 68)

NOTE

See "5-3-6. TEST & INFO" on page 71 for how to check sensor connections.

Up to 16 sets of measurement condition can be saved as works. The work can be changed on the WORK settings screen or by using "Switch work 1" to "Switch work 8" with the control signal input terminals (CONTROL connector) (page 25).

To open the WORK screen, touch the buttons in the following order on the Home Screen.

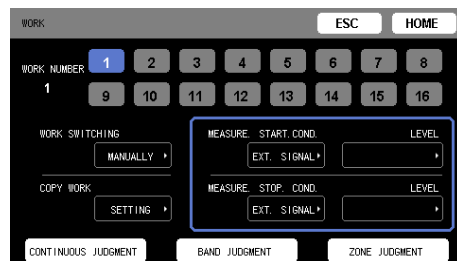

WORK NUMBER

Select the work number to make settings for.

WORK SWITCHING

Select the method used to select the work during measurement.

EXT. INPUT: Select works using "Switch work" 1-8 signals through the control signal input terminals (CONTROL connector).

MANUALLY: Select the work manually using the WORK settings screen.

COPY WORK

Use this to copy work settings.

MEASURE. START.

Set the measurement starting method (page 53).

COND.

Select the signal used for the trigger.

LEVEL

Set the trigger level.

- When the starting condition is "EXT. SIGNAL", the measurement starting level setting has no effect.

MEASURE. STOP.

Set the measurement stopping method (page 53).

COND.

Select the signal used for the trigger.

LEVEL

Set the trigger level.

- When the stopping condition is "EXT. SIGNAL", the measurement stopping level setting has no effect.

NOTE

- Settings related to works are explained in "4-5. Work settings" on page 44.
- Displacement conditions are only enabled when the X axis is displacement.

COPY WORK

Use this to copy work settings to a different work number.

The number shown in "COPY SOURCE" is the current work number. Select the source work to copy before touching the COPY WORK SETTING button.

Touch the COPY WORK SETTING button to open the COPY WORK screen. Then, select the work number for the copy destination, and touch the OK button to copy the settings.

When "ALL" is set as the "COPY DESTINATION", settings will be copied to all the work numbers other than the current one.

4-5-1. CONTINUOUS JUDGMENT

Measurement values are compared to comparison values to conduct judgment.

Continuous judgment is conducted when "CONTINUE" is the status displayed on the screen.

Setting items

Touch the buttons in the following order on the Home Screen.



Set the comparison values to use for judgment.

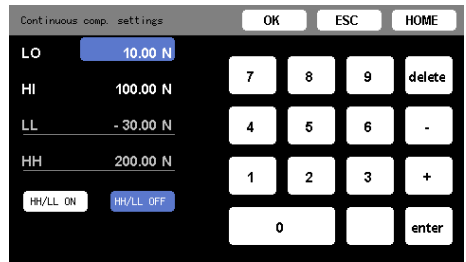

LO

Set the low limit value.

HI

Set the high limit value.

LL

Set the low low limit value.

HH

Set the high high limit value.

HH/LL ON, HH/LL OFF

Select "HH/LL ON" to use high high limit and low low limit.

NOTE

- Set the size relationships of the comparison values as follows.
 $LL < LO < HI < HH$
- During measurement triggered by "Start/stop measurement" control signals or the START button, band or zone judgment will be output. Continuous judgment will not be conducted.

4. Settings

4-5-2. BAND JUDGMENT

Measurement waveforms are compared to comparison waveforms to conduct judgment.

Instead of high limit, low limit and other fixed values for continuous judgment, any curved line can be used for comparison.

Band judgment is conducted when "REC" is the status displayed on the screen.

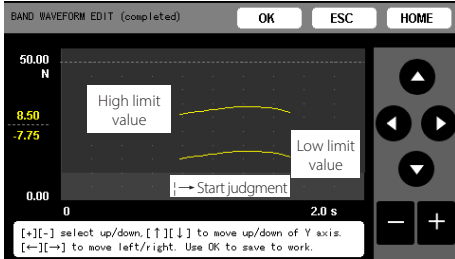

4-5-2-1. Band judgment settings

Touch the buttons in the following order on the Home Screen.



This sets management values for the load and judges whether these values are exceeded.



To use band judgment, after setting SELECT REF. WAVE to SELECT, set WAVEFORM COMP. to ENABLE.

- If no reference waveform has been set, the following "WAVEFORM COMP." item cannot be set to "ENABLE".

SELECT REF. WAVE

Set the waveform to use for reference.



WAVE SAMPLING

Use measured data for reference.

WAVE LOADING

Load a waveform saved in the unit.

WAVE SAMPLING

Touch the WAVE SAMPLING button and then touch the OK button. If a comparison waveform has been saved in the current work, it will be shown. If not, the following screen will open.

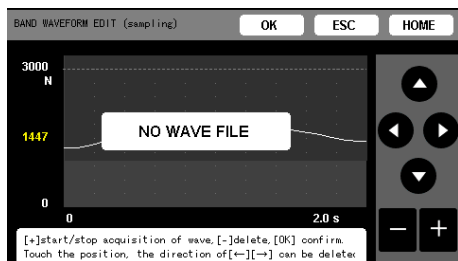

1 Touch the + button to start measurement.

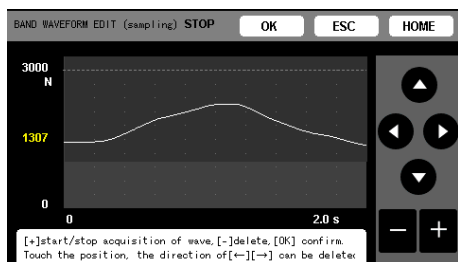

NOTE

- The measured value is shown in the middle of the Y axis.
- Touch the + button again during waveform sampling to stop sampling at that point.

2 After measurement, touch the OK button to save the waveform.

This will open the comparison waveform editing screen.

- Touch the – button to redo measurement.

Editing comparison waveforms

1 Touch the beginning position of the comparison waveform to show the cursor, and touch the ◀ button to remove the unnecessary part.

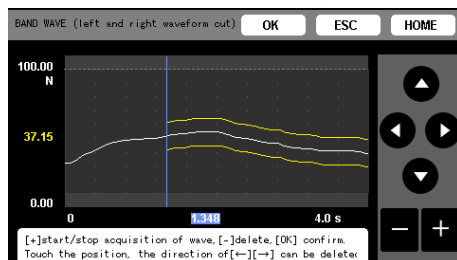

2 Touch the ending position of the comparison waveform to show the cursor, and touch the ▶ button to remove the unnecessary part. Then, touch the OK button.

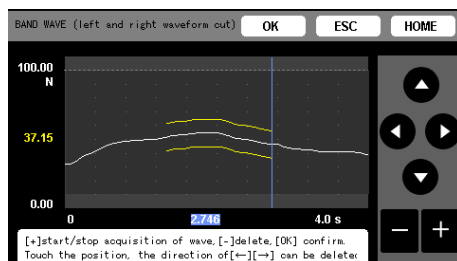

3 Move the comparison waveform to the desired position.

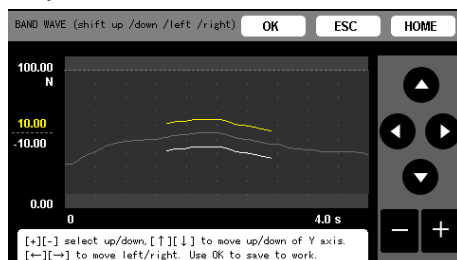

Follow the operation procedures at the bottom of the screen to move the comparison waveform.

NOTE

The offset positions of the high and low limits relative to the reference values are shown in the middle of the Y axis.

4 Touch the OK button to save the waveform, and touch the ESC button twice to close the screen.

4. Settings

Loading waveforms

Touch the WAVE LOADING button, and touch the OK button. A list of measurements will be shown. Use the ▲ and ▼ buttons to select the data, and touch the ENT button to load the waveform.



4-5-3. Zone judgment

For zone judgment, judgment zones for load and time or load and displacement are set, and hold values are judged to determine whether or not they are within a zone.

Band judgment is conducted when "REC" is the status displayed on the screen.

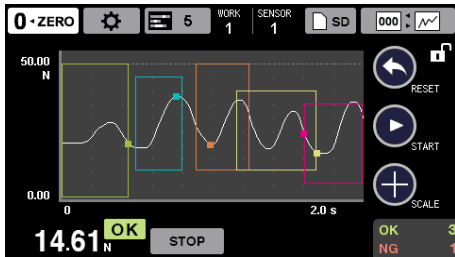

Zone judgment settings

The range set with range setting is called a zone.

- A maximum of five zones can be set.
- The judgment method is set for each zone.
- Zones can overlap.

When the waveform display horizontal axis is time

Set load management values, and conduct judgments.

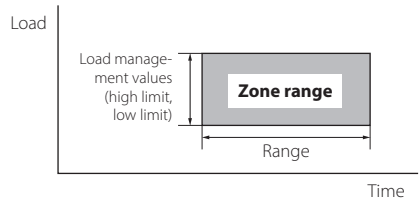

When the waveform display horizontal axis is displacement

Set load and/or displacement management values, and conduct judgments.

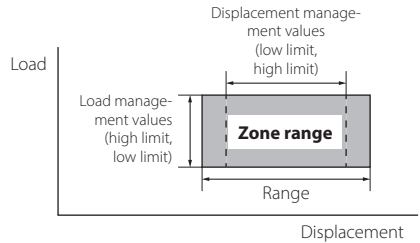

NOTE

When the waveform display horizontal axis is displacement, all zone settings will be set to displacement. They cannot be set to time.

4-5-3-1. Judgment method

- Select the hold method used when measurement data is in the judgment range.
- If the hold values are within the management value range, judgment for that zone will be OK.
- If judgment for all zones is OK, the judgment for that measurement will be OK.
- Judgment outputs (displacement) are output only when the waveform display horizontal axis is displacement. Depending on the judgment method, however, judgment output (displacement) might not be output. For details, see the explanations for each judgment method.

4-5-3-2. Setting examples

For details about each setting item, refer to the following explanations.

Peak hold

This explanation uses settings for conducting peak holds with multi-zone judgment as an example. (A displacement sensor is not used in this example.)

Touch the buttons in the following order on the Home Screen to open the settings screen.

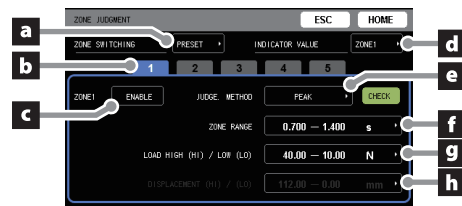

a ZONE SWITCHING

Select PRESET.

NOTE

Holds will occur when measurement values are in the zone.

b Zone

Select 1.

NOTE

Any number from 1 to 5 can be selected.

c Zone 1

Select ENABLE.

NOTE

The judgment method will be conducted simultaneously for enabled zones, so be sure that unneeded zones are not enabled.

d Indicator value display

Select ZONE 1.

NOTE

This shows ZONE 1 hold values after measurement.

e JUDGE. METHOD (judgment method)

Select PEAK.

f ZONE RANGE

Select 0.700–1.400 s.

NOTE

After starting measurement, peak holds will be conducted for 0.700–1.400 seconds.

To conduct peak holds for the time between measurement start and finish, set the 0–X axis full scale value (page 29).

g LOAD HIGH (HI)/LOW (LO)

Select 40.00–10.00 N.

NOTE

Set the range for OK judgment.

h DISPLACEMENT (HI)/(LO)

This is not used.

The results measured with the above settings will be as follows.

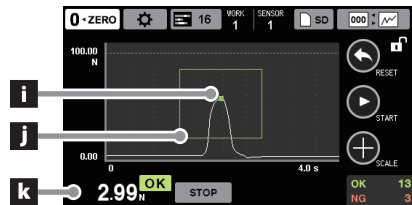

i Hold position

NOTE

This is the peak hold point with these settings.

j Zone range display

The range designated with the ZONE RANGE setting and the LOAD HIGH (HI)/LOW (LO) limits is shown with a rectangle.

k Load indicator value

NOTE

This shows the peak value with these settings.

4. Settings

Multi-zone judgment (3 points)

This explanation uses settings for conducting peak, bottom and inflection point holds with multi-zone judgment as an example. (A displacement sensor is not used in this example.)

Touch the buttons in the following order on the Home Screen to open the settings screen.



Peak hold

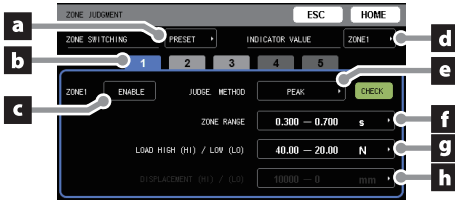

Follow the explanation in the previous section to set the peak hold. In the settings screen above, the following settings have been changed to explain multi-zone judgment.

f ZONE RANGE

Select 0.300–0.700 s.

g LOAD HIGH (HI)/LOW (LO)

Select 40.00–20.00 N.

h DISPLACEMENT (HI)/(LO)

This is not used.

Bottom hold

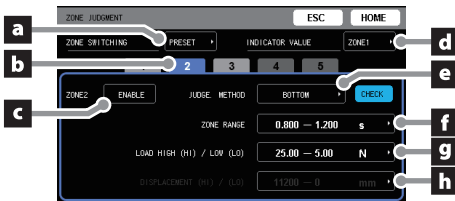

b Zone

Select 2.

c Zone 2

Select ENABLE.

e JUDGE. METHOD (judgment method)

Select BOTTOM.

f ZONE RANGE

Select 0.800–1.200 s.

NOTE

Set the range to conduct the hold.

g LOAD HIGH (HI)/LOW (LO)

Select 25.00–5.00 N.

NOTE

Set the range for OK judgment.

h DISPLACEMENT (HI)/(LO)

This is not used.

Inflection point hold

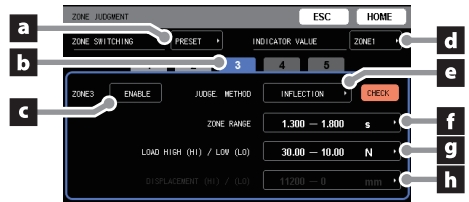

b Zone

Select 3.

c Zone 3

Select ENABLE.

e JUDGE. METHOD (judgment method)

Select INFLECTION.

f ZONE RANGE

Select 1.300–1.800 s.

NOTE

Set the range to conduct the hold.

g LOAD HIGH (HI)/LOW (LO)

Select 30.00–10.00 N.

NOTE

Set the range for OK judgment.

h DISPLACEMENT (HI)/(LO)

This is not used.

For inflection points, further settings must be made to conduct inflection point holds. After selecting INFLECTION for the judgment method, touch the selection button again to open the settings screen.

See "4-6-4-2-8-1. Setting items" on page 64 for information about setting items, and set values suitable for the waveforms to be measured.

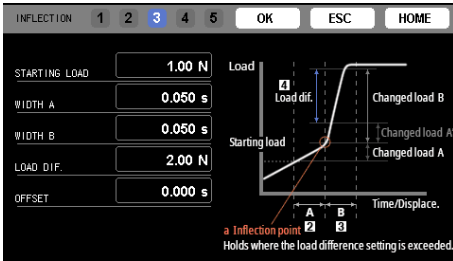

The results measured with the above settings will be as follows.

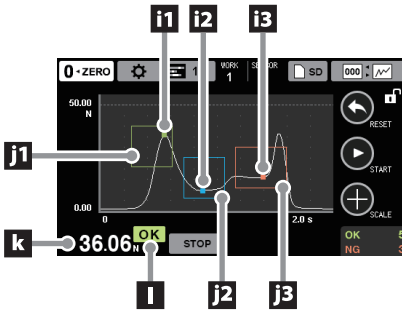

i Hold position

- i1: Peak hold position
- i2: Bottom hold position
- i3: Inflection point hold position

j Zone range display

The range designated with the ZONE RANGE setting and the LOAD HIGH (HI)/LOW (LO) limits is shown with a rectangle.

- j1: Peak hold zone
- j2: Bottom hold zone
- j3: Inflection point zone

NOTE

Zone display colors

1: olive, 2: cyan, 3: orange, 4: light yellow, 5: pink

k Load indicator value

NOTE

- These settings will show the peak value of zone 1.
- To show the hold value of a different zone, set the indicator value display to that zone.

l Load judgment

NOTE

For multi-zone judgment cases, if the judgment for all zones is OK, the judgment will be OK.

4. Settings

4-5-4. Band + Zone judgment

4-5-4-1. Setting examples

This explanation uses settings for conducting band judgment and multi-zone judgment (with peak and inflection point holds) as an example. (A displacement sensor is not used in this example.)

In the following example, multi-zone judgment settings are made first, but settings can be made for either band judgment or multi-zone judgment first.

Touch the buttons in the following order on the Home Screen to open the settings screen.



a SELECT REF. WAVE

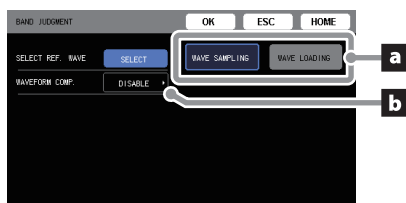

To newly measure a reference waveform, select “WAVE SAMPLING”. After that, save the reference waveform, referring to “WAVE SAMPLING” on page 47 and “Editing comparison waveforms” on page 47.

To load a waveform saved in the unit as the reference waveform, select “WAVE LOADING”. After that, save the reference waveform, referring to “Loading waveforms” on page 48 and “Editing comparison waveforms” on page 47.

b WAVEFORM COMP.

Select ENABLE.

ATTENTION

If no reference waveform has been set, ENABLE cannot be selected.

Touch the HOME button to return to the Home Screen, and touch the buttons in the following order to open the settings screen.



Peak hold

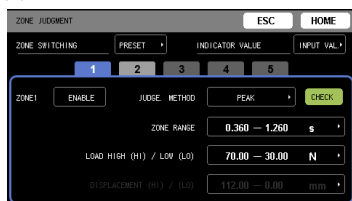

Follow the explanation in “Peak hold” on page 49 to set the peak hold.

Inflection point hold

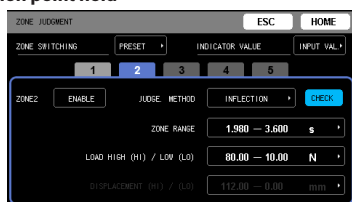

Follow the explanation in “Inflection point hold” on page 50 to set the inflection point hold.

NOTE

Work numbers do not have to be set consecutively.

The results measured with the above settings will be as follows.

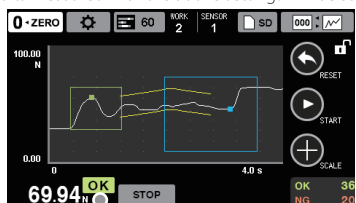

c Load judgment

OK will appear when both band judgment and multi-zone judgment are OK.

NOTE

Judgment output (load OK) of the control signal output terminal becomes ON when both band judgment and multi-zone judgment are OK, but band judgment output is the output of only band judgment.

4-5-5. CURRENT BAND WAVE & MULTI-ZONE ARRANGEMENT screen

Touch the waveform display area on the waveform display screen to open the CURRENT BAND WAVE & MULTI-ZONE ARRANGEMENT screen.

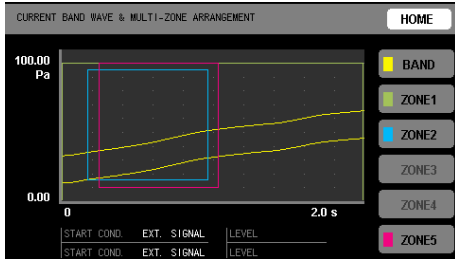

Touch below the X axis to open the WORK settings screen.

Displaying and moving bands and specific zones

Touch the button of an item to be shown or moved to show only the range of that item
ZONE 2 has been selected in the example below.

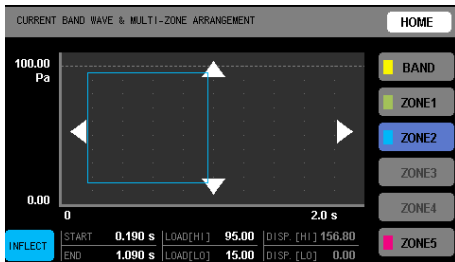

Use the ▲ ▼ ◀ ▶ buttons to move the zone in the desired direction.

4-6. Start/stop measurement

In the following explanation, operation is for when EXT. START/STOP has been set to "EDGE" (page 26).

4-6-1. Measurement start/stop settings for zone judgment

Touch the buttons in the following order on the Home Screen to open the settings screen.



When the work settings screen opens, touch a button below "COND." or "LEVEL" to set the method to start or stop measurement.

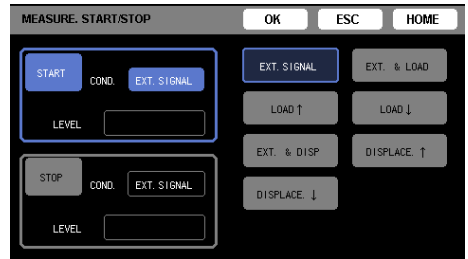

NOTE

Use control signal input terminal number 35 (start/stop measurement) of the CONTROL connector to control measurement starting and stopping (page 25).

4-6-1-1. Measurement starting settings

EXT. SIGNAL

Measurement starts when an external signal becomes on or when the waveform display START button is touched. See "4-6-4. Zone judgment timing chart" on page 56 for details.

EXT. & LOAD

After an external signal start condition is realized, measurement will start when the load exceeds the start level (AND condition).

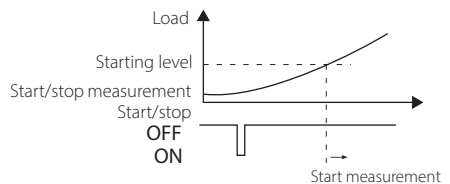

4. Settings

EXT. & DISP.

In the same manner as with "EXT. & LOAD" above, after an external signal start condition is realized, measurement will start when the displacement exceeds the start level (AND condition).

LOAD ↑

Measurement will start when the load increases to above the start level. Standby will continue after measurement completes.

LOAD ↓

Measurement will start when the load decreases to below the start level. Standby will continue after measurement completes.

DISPLACE. ↑

Measurement will start when the displacement increases to above the start level. Standby will continue after measurement completes.

DISPLACE. ↓

Measurement will start when the displacement decreases to below the start level. Standby will continue after measurement completes.

When in load/displacement ↑ ↓ standby, STOP will appear with a yellow background rather than the usual gray to show the state clearly.

STOP appearance when in standby

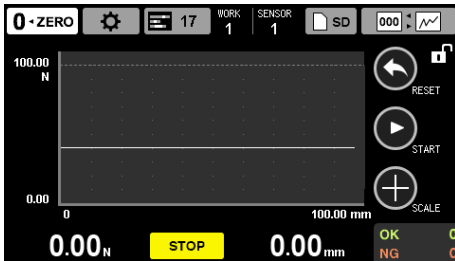

4-6-1-2. Measurement stopping settings

EXT. SIGNAL

Measurement stops when an external signal becomes on or when the waveform display STOP button is touched. See "4-6-4. Zone judgment timing chart" on page 56 for details.

EXT. | LOAD

After an external signal stop condition is realized, measurement will stop when the load stop level meets one of the following conditions (OR condition).

- If the measurement starting load value \leq Stop level
Measurement will stop when the load value exceeds the stop level.
- If the measurement starting load value $>$ Stop level
Measurement will stop when the load value becomes equal to or less than the stop level.

EXT. | DISP.

In the same manner as with "EXT. | LOAD" above, measurement will stop when an external signal stop condition is realized or when the displacement crosses the stop level (OR condition).

EXT. | TIME

Measurement will stop after an external signal stop condition is realized or the set time has elapsed.

ATTENTION

- When the graph X axis is time:
Even if a stop condition is not realized, measurement will stop when the time set for "X AXIS FULL SCALE" has elapsed.
- When the graph X axis is displacement:
Even if a stop condition is not realized, measurement will stop when the displacement set for "X AXIS FULL SCALE" is realized.
- During measurement, any of the following operations will stop measurement and cause measured data to be discarded.
 - Control signal input terminal number 27 (force reset) is turned on (CONTROL connector).
 - Control signal input terminal number 33 (clear results (reset measurement results)) is turned on (CONTROL connector).
 - The RESET button shown on the screen is touched.
- The graph will begin to be drawn when measurement starts.
- When the X axis is time, data will be saved and the graph will be drawn with 0 seconds as the measurements start.
- When the X axis is displacement, data will be saved with 0 mm as the measurements start, and the graph will be drawn according to the indicator values.

4-6-2. Continuous judgment timing chart

- Turning the unit on starts continuous judgment.
- Starting measurement stops continuous judgment and starts judgment as set by the work.
- After measurement completes, touch the Reset button or set "Clear results (reset measurement results)" to ON for the control signal input terminal (CONTROL connector) to start continuous judgment.

Judgment output operation is as follows.

- HH: high high limit value < indicator value
- HI: high limit value < indicator value
- LO: indicator value < low limit value
- LL: indicator value < low low limit value

Judgment output example

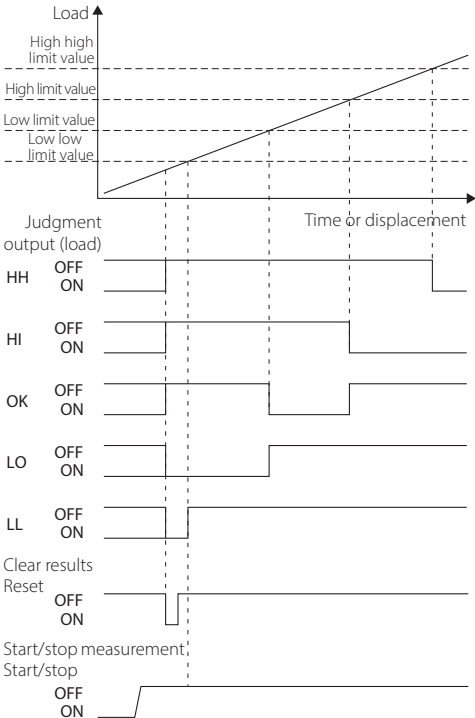

ATTENTION

After measurement using another judgment, setting the Clear results signal to ON will start continuous judgment.

4-6-3. Band judgment timing chart

To start and stop measurement, use the start/stop button on the waveform display screen or use "Start/stop measurement" with the control signal input terminal (CONTROL connector).

The X axis shows time based on the start of measurement or the change in displacement.

Judgment starts when the measured value exceeds the comparison value starting point and is confirmed when it exceeds the comparison value ending point.

Judgment output example

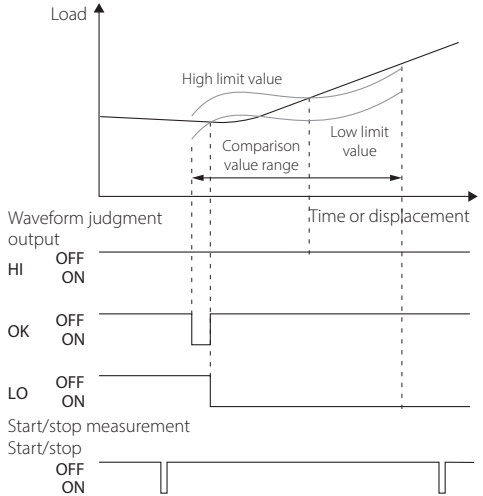

Waveform judgment output operation is as follows.

- HI: high limit value < load
- LO: load < low limit value

Once HI or LO becomes ON, that state is retained and judgment operations stop.

OK becomes ON when the following conditions are fulfilled after the measurement value exceeds the comparison value starting point.

$$\text{Low limit value} \leq \text{load} \leq \text{high limit value}$$

4. Settings

4-6-4. Zone judgment timing chart

Switch zone

This is enabled when the "ZONE SWITCHING" setting on the ZONE JUDGMENT screen is set to "EXT. INPUT" (page 57). The zone section is determined by signal ON and OFF.

HI and LO judgment outputs (load/judgment)

The indicator value during constant comparison or the hold value at other times is compared to the high and low limits and judgment is output.

HI: high limit value < load or hold value

LO: load or hold value < low limit value

Both HI and LO can become ON.

OK judgment output timing

This becomes ON when all judgments in the enabled zone become OK.

4-6-4-1. Setting items

Touch the buttons in the following order on the Home Screen.



Timing example

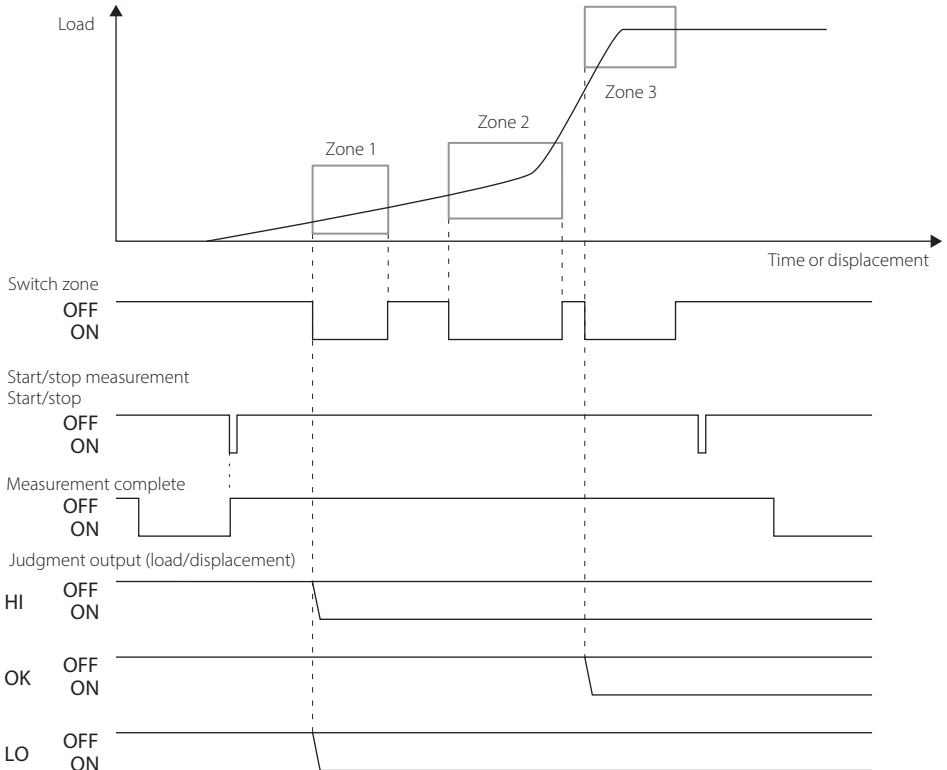

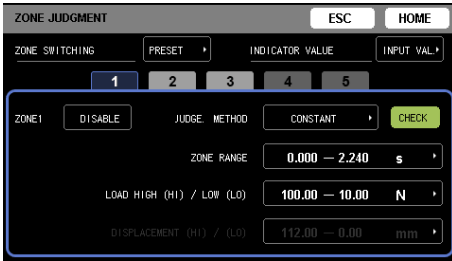

ZONE SWITCHING

Set the zone selection method.

PRESET: Use the work setting.

EXT. INPUT: Use the "Switch zone" signal from the control signal input terminal (CONTROL connector) to change zones (page 56).

- Zone switching will occur in order from the lowest numbered zone set to "ENABLE" in advance. Settings other than the zone range will be used as is.

INDICATOR VALUE

Select the value shown as the indicator value on the Home Screen.

To hold an indicator value at a judgment value in a specific zone, select the zone.

Zone number (1, 2, 3, 4, 5)

Zone number to set

Zone # (number of selected tab)

ENABLE: Use this zone for judgment.

DISABLE: Do not use this zone for judgment.

JUDGE. METHOD (judgment method)

Select the hold method used when measurement data is in the zone.

CHECK

The button color shows the zone display color. When the zone is enabled, touch to show the current zone on the graph.

ZONE RANGE

Set the range of the X axis.

The X axis unit is set on the SENSOR screen.

This is enabled when ZONE SWITCHING is "PRESET".

ATTENTION

The maximum zone range values are "X AXIS FULL SCALE" for the X axis (page 29) and "MAX. DISP. VALUE" for the Y axis (page 40).

LOAD HIGH (HI)/LOW (LO)

Set the Y axis management values in the zone.

DISPLACEMENT (HI)/(LO)

For X axis displacement, set the displacement management values in the zone.

ATTENTION

For details about the method for judging displacement, see "4-6-4-2. Judgment method" on page 58.

To conduct displacement judgment, the X axis must be set to displacement, and the displacement high and low limit values must be set within the zone.

Example of multi-zone judgment display

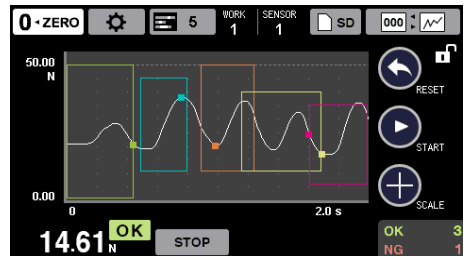

- If a valid value is set as the displacement management value, a dotted vertical line will appear in the zone.

4. Settings

4-6-4-2. Judgment method

Select the hold method used when measurement data is in the zone.

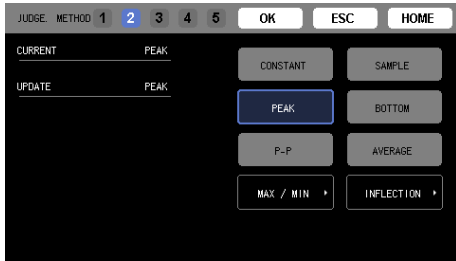

The following types of holds are possible.

CONSTANT, SAMPLE, PEAK, BOTTOM, P-P, AVERAGE, MAX/MIN, INFLECTION

NOTE

After selecting MAX/MIN or INFLECTION, touch it again to open the settings screen.

4-6-4-2-1. Constant comparison

When a measurement value is within a zone, it is compared to the high and low limits and judged.

HI: high limit value < measurement value

LO: measurement value < low limit value

Judgment output (load)

This becomes ON at the moment that the load meets a HI or LO condition. Both HI and LO can become ON.

If the load is never outside the zone, the zone judgment will be OK.

4-6-4-2-2. Sampling

The measurement value is held when it enters a zone. The hold is released when it leaves the zone.

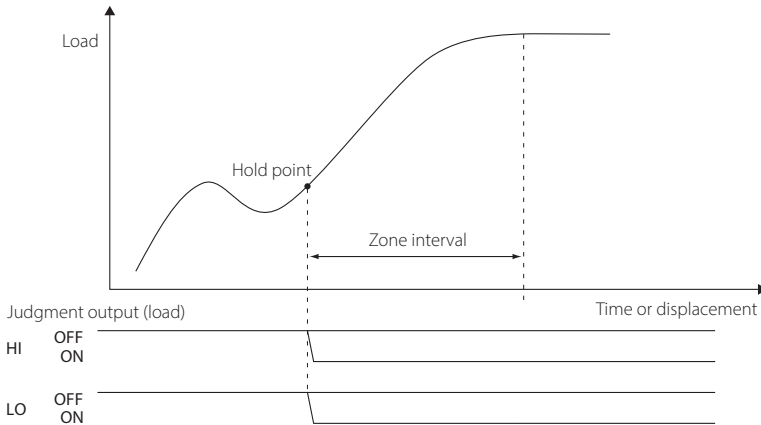

Judgment output (load)

If the hold point meets a HI or LO condition, this becomes ON.

If the hold point is within the management value range, judgment for this zone will be OK.

4-6-4-2-3. Peak

The load peak is held when measurement values are in the zone.

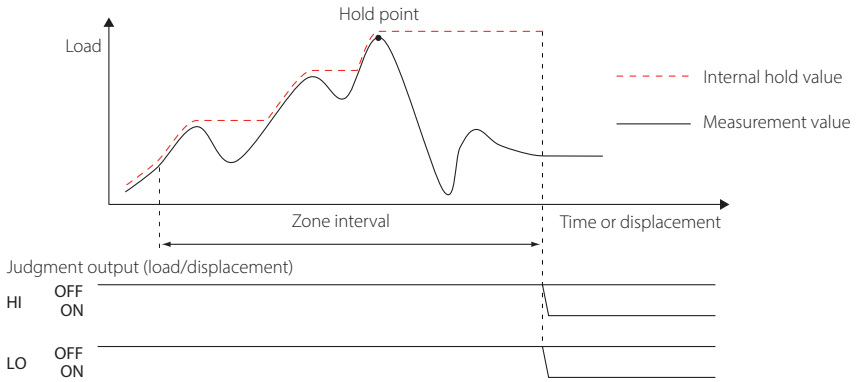

Judgment output (load/displacement)

If the hold point meets a HI or LO condition, this becomes ON.

If the hold point is within the management value range, judgment for this zone will be OK.

4-6-4-2-4. Bottom

The minimum (bottom) load value is held when measurement values are in the zone.

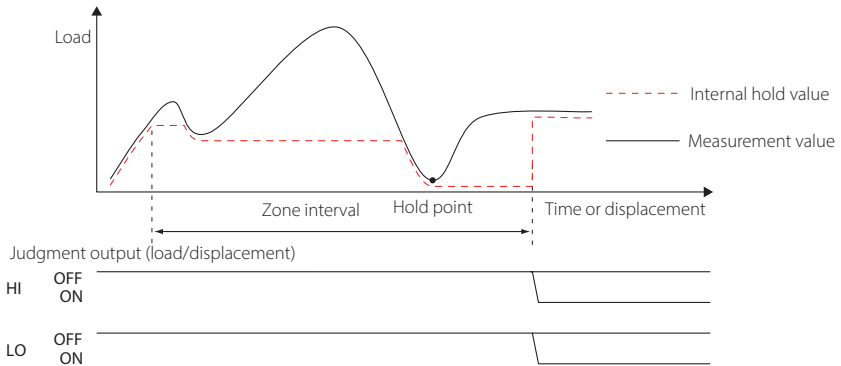

Judgment output (load/displacement)

If the hold point meets a HI or LO condition, this becomes ON.

If the hold point is within the management value range, judgment for this zone will be OK.

4. Settings

4-6-4-2-5. Peak to peak

With the point when the zone was entered as zero, the maximum difference between the maximum (peak) and maximum negative-direction (bottom) values for load becomes the hold value when measurement values are in the zone.

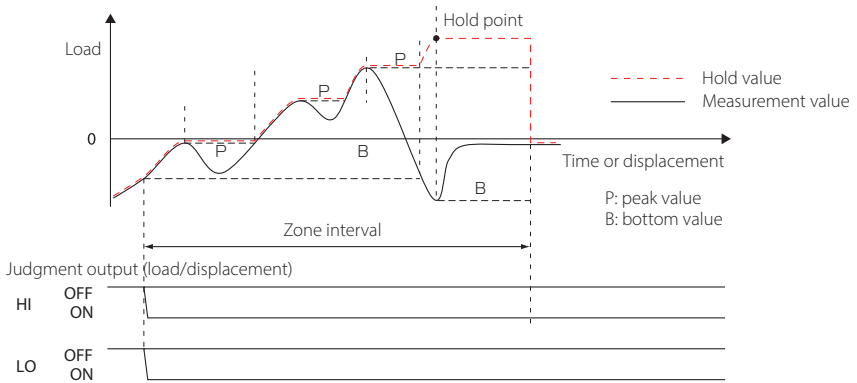

Judgment output (load/displacement)

If the hold point meets a HI or LO condition, this becomes ON.

If the hold point is within the management value range, judgment for this zone will be OK.

4-6-4-2-6. Average value

Calculation of the load average begins when measurement values enter the zone.

The average value of the final position in the zone will be held.

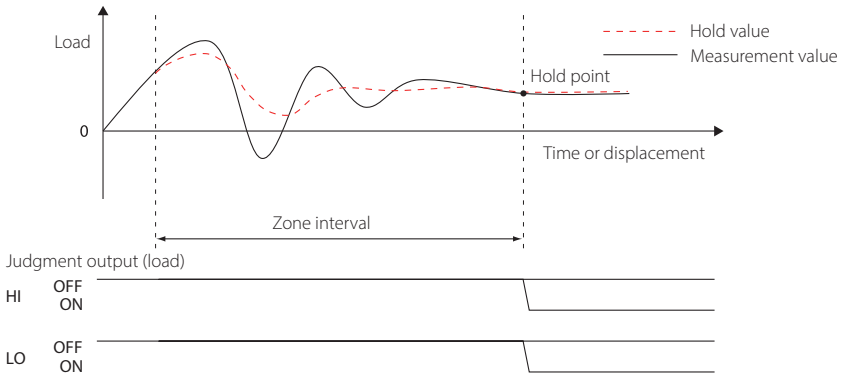

Judgment output (load)

If the hold point meets a HI or LO condition, this becomes ON.

If the hold point is within the management value range, judgment for this zone will be OK.

4-6-4-2-7. Maximum/minimum

The maximum and minimum load values are detected when measurement values are in the zone.

At the moment that the load difference \times scaling factor occurs the number of times set for the detection count, the points when the maximum and minimum values occurred will become the hold points.

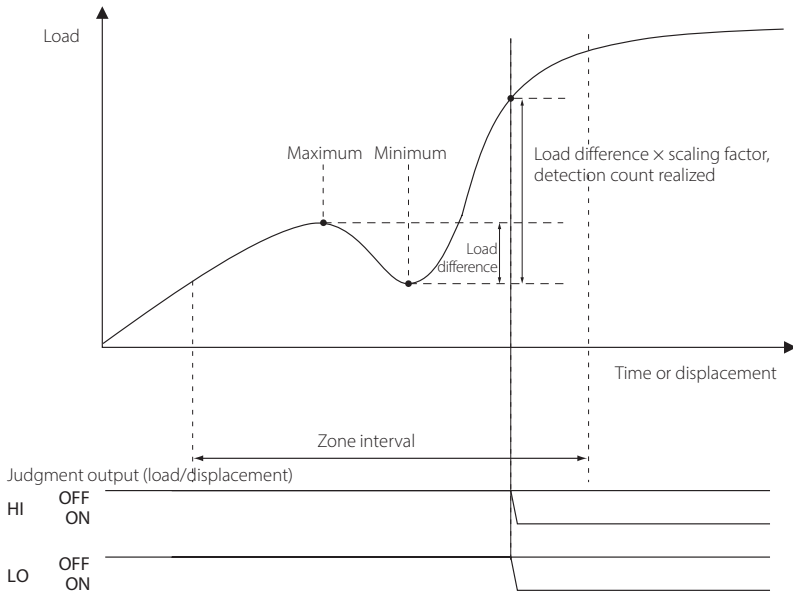

Judgment output (load/displacement)

If the hold point meets a HI or LO condition, this becomes ON.

If the hold point is within the management value range, judgment for this zone will be OK.

4. Settings

4-6-4-2-7-1. Setting items

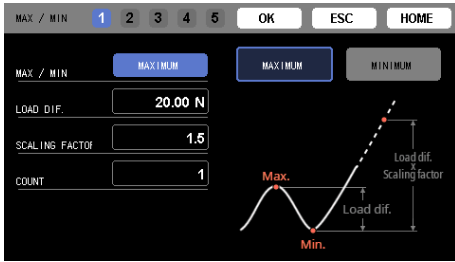

MAX, MIN

Select whether to hold at the maximum or the minimum value.

LOAD DIF.

Set the load value of the difference between the maximum and minimum.

SCALING FACTOR

Input the condition for detecting maximum/minimum values as a scaling factor.

COUNT

Hold after the set number of times that the condition for detecting maximum/minimum values is fulfilled.

Detecting the maximum/minimum

After the maximum or minimum value is detected, at the time when the load value exceeds the load difference \times the scaling factor, the A point is held if it is a maximum value hold or the B point is held if it is a minimum value hold.

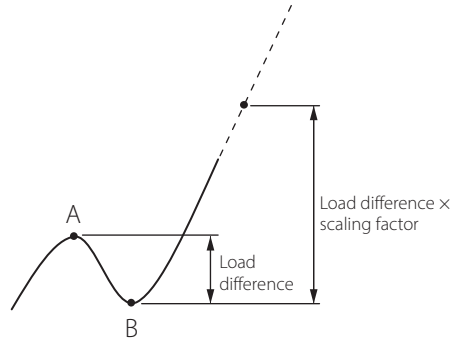

4-6-4-2-8. Inflection point

When measurement values are in the zone, change in the slope of the load value is identified and held.

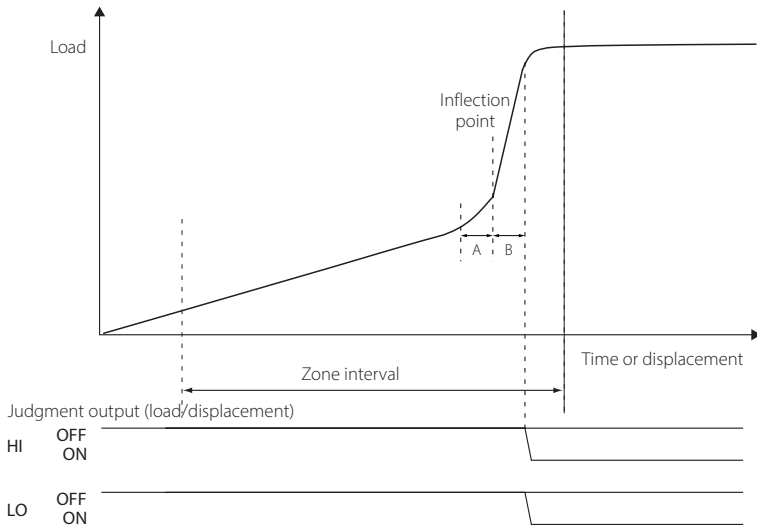

Judgment output (load/displacement)

If the inflection point meets the conditions for HI or LO, this becomes ON.

If the inflection point is within the management value range, judgment for this zone will be OK.

4. Settings

4-6-4-2-8-1. Setting items

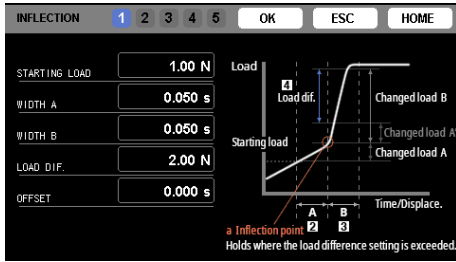

When measurement values are in the X axis of the zone, change in the slope of the load value is identified and held.

STARTING LOAD

Set the starting load value for inflection point holds. After measurement starts, inflection point hold will start when the load exceeds the STARTING LOAD.

WIDTH A

Set the unit to time or displacement amount.

WIDTH B

Set the unit to time or displacement amount.

LOAD DIF.

Input the setting value for evaluating the load change value (D).

OFFSET

The inflection point is moved back by the amount of offset.

Inflection point detection

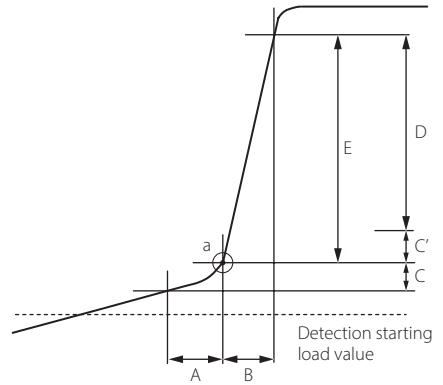

With the changed load of WIDTH A as C and the changed load of WIDTH B as E, when the value of $E - C$ (D) exceeds the LOAD DIF. setting value, point a will be held as the inflection point. Typically, A is set equal to the B. By setting A lower than B when the slope is gentle, however, detecting the inflection point becomes easier.



5-1. Lock and language settings

Touch the  button on the HOME Screen to show the SETTINGS screen.



LOCK STATUS

The calibration (CAL), work (WORK) and all (ALL) lock states are shown with icons.

-  Locked
-  Unlocked

Touch an icon to open the lock status setting screen.

- Password locking can be set for the ALL LOCK option. The password is fixed to "6803".

LANGUAGE

Use to set the display language.

5-1-1. Lock settings

Changing calibration values and work setting values can be prohibited.

Touch a lock status icon on the SETTINGS screen to change the lock status.

To change a setting, touch the setting value display button and select UNLOCK or LOCK.



- The calibration value lock setting can also be changed on the load cell and displacement sensor screens. They both change the same calibration value lock setting. Locking the calibration value for only load cells or only displacement sensors is not possible.

- Values for locked settings appear green in the menu and cannot be changed.
- ALL LOCK prevents opening any SETTINGS menu other than LOCK STATUS. This also activates CALIBRATION LOCK and WORK LOCK. Deactivating ALL LOCK also deactivates CALIBRATION LOCK and WORK LOCK.

5-1-2. Language setting

This can be set to Japanese, English, Chinese or Korean.

5. System settings

5-2. Memory and counter settings

To open the SYSTEM screen, touch the buttons in the following order on the Home Screen.

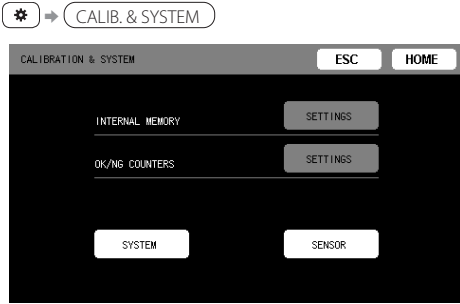

Use this to make unit settings and calibrate sensors.

SYSTEM

For information about system settings, see “5-3. Various settings” on page 67.

SENSOR

For information about sensor settings, see “4-2. SENSOR settings” on page 29.

5-2-1. INTERNAL MEMORY

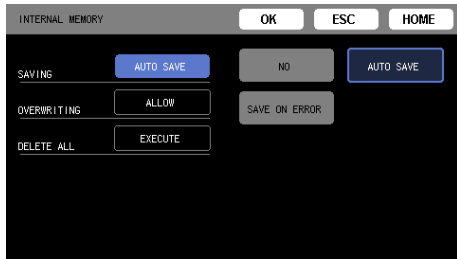

Use this to set measurement data saving.
Up to 70 data can be saved.

ATTENTION

Data saved in the built-in memory is shown in a list of measurement results. Waveforms can also be checked.
To check all data, set “SAVING” to “AUTO SAVE” and, as necessary, set “OVERWRITING” to “ALLOW”.

SAVING

- NO: do not save
- AUTO SAVE: save everything
- SAVE ON ERROR: save all not judged OK

OVERWRITING

- ALLOW: overwrite the oldest data when the internal memory becomes full
- FORBID: do not overwrite any data

DELETE ALL

- Touch EXECUTE to delete all data

5-2-2. OK/NG COUNTERS



Use this to reset counters.
Select the counter to reset and touch the OK button to reset it.

5-3. Various settings

To open the SYSTEM screen, touch the buttons in the following order on the Home Screen.

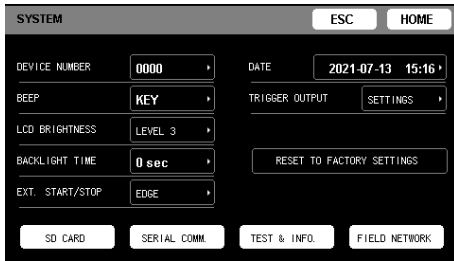

DEVICE NUMBER

This sets the identification number of the unit.

BEEP

This sets whether the beep sounds or not when using screen operations and when judgment errors are output.
OFF: The beep never sounds.

KEY: The beep sounds during screen operations.

KEY+JUDGE: The beep sounds during screen operations and when judgments are not OK.

LCD BRIGHTNESS

Adjust the brightness of the LCD screen backlight.

NOTE

"LEVEL 4" is the brightest, and "LEVEL 1" is the dimmest.

BACKLIGHT TIME

Set the amount of time without any button operations until the backlight turns off.

To have the backlight turn off, set the value between 1 and 255 (seconds).

The backlight will not turn off when set to 0.

NOTE

The brightness at this time is according to the backlight setting.

Button operations are only enabled when the backlight is lit.

EXT. START/STOP

Select the external input connector measurement starting/stopping mode (page 26).

DATE

Set the unit's built-in clock.

The clock time is used for file timestamps and saved with recorded data.

TRIGGER OUTPUT

The threshold can be set as desired for load, displacement or OK/NG count value, and triggers can be output to Trigger outputs 1 and 2 (page 68).

RESET TO FACTORY SETTINGS

All the settings of this unit can be initialized to their factory default values.

- The Home Screen display selection (indicator value or waveform display) and the language setting are retained.

5-3-1. DATE & TIME SETTING

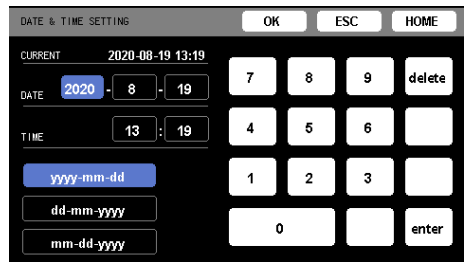

DATE, TIME

The blue rectangle shows the item being input. Use the number keys to input values.

Change the input item by touching a white rectangle with a finger, for example.

The date format display options are as follows.

[yyyy-mm-dd]
[dd-mm-yyyy]
[mm-dd-yyyy]

- The abbreviations are as follows.
yyyy: 4-digit AD year
mm: 2-digit month
dd: 2-digit day
- The setting range for the year is 2000–2099.
- If this unit is not used for a long time, the date and time shown could become January 1, 2000. If this occurs, set the correct date and time before use.
- Dates and times are saved in measurement results. The built-in clock has a monthly discrepancy of about 90 seconds. If accurate times are necessary, set the date and time just before beginning measurement.

5. System settings

5-3-2. TRIGGER OUTPUT

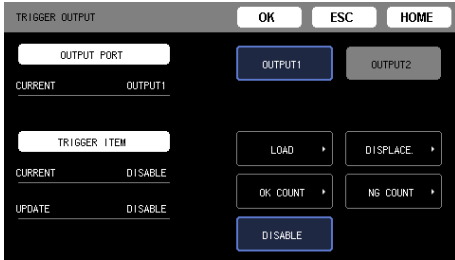

High and low limits can be set for load and displacement. The number of times can be set for OK/NG count.

NOTE

Trigger output is always judged regardless of measurement mode.

5-3-3. RESET TO FACTORY SETTINGS

All the settings of this unit can be initialized to their factory default values.

ATTENTION

The following procedure will initialize all the settings in the setting value memory, including calibration values.

- The Home Screen display selection (indicator value or waveform display) and the language setting are retained.

5-3-4. SD CARD



AUTO SAVE

NO: do not save

AUTO SAVE: save everything

SAVE ON ERROR: save all not judged OK

- If "AUTO SAVE" or "SAVE ON ERROR" is selected, but no SD card is loaded in the unit, measurement will occur without saving recording data.

FORMAT

Use to format the SD card (page 69).

EXPORT SETTINGS

Setting values can be saved to SD cards.

- A file with the name "td9kt_settings.csv" will be saved in the root folder. If a file with the same name already exists, that file will be renamed "td9kt_settings.bak" before setting values are saved. If a "td9kt_settings.bak" file already exists, it will be deleted before a new one is saved.

IMPORT SETTINGS

Setting values can be imported from an SD card and used to overwrite the settings of the unit.

- This could take up to one minute if band waveforms are saved.
- After setting values have been imported, the unit will automatically restart.

ATTENTION

- Use this unit to format SD cards that you will use with it in advance.
- Do not edit the saved data. Doing so could make it impossible to load correctly.
- If data saved on a device of a different version or with different options is loaded, the parts that do not match this unit will not be loaded.

5-3-4-1. FORMAT

When formatting, the “RESULTS SAVE FOLDER” and “MAX NUM OF FILES” can be set.

The defaults are “ROOT” and “0000” (no limit).

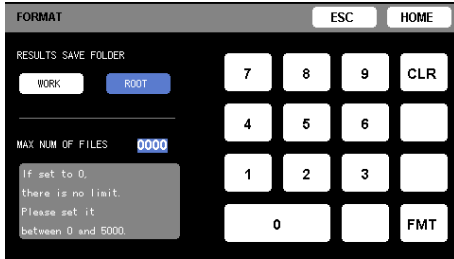

RESULTS SAVE FOLDER

This sets the folder when measurement results are saved to the SD card.

ROOT: All measurement results will be saved to the root folder.

WORK: Measurement results will be saved to the folder for the work number selected at the time of measurement.

ATTENTION

- This can be changed only when formatting the SD card.
- Files for saving setting values and screenshots are always saved in the root folder.

MAX NUM OF FILES

The maximum number of files that can be saved in each folder can be set using number keys.

The number of files will not be limited when this is set to 0.

The maximum number of files can be set between 1 and 5000.

ATTENTION

- This can be changed only when formatting the SD card.
- When the maximum number of files is reached, files will be overwritten from the oldest first.
- When set to use “WORK” folders, the maximum number will be applied within each work folder.
- Changing the date and time setting could cause the maximum number of files function to not work properly. After changing the date and time setting, back up the necessary files from the SD card and then format it before using it again.
- The settings for “RESULTS SAVE FOLDER” and “MAX NUM OF FILES” are saved on the unit itself. If the setting values differ from the unit because the SD card was formatted by another device, for example, it will not operate properly. Format SD cards with the unit they will be used with before use.

NOTE

If the number of files becomes great, writing to the SD card will take longer due to the file system. In this case, the increase in writing time can be limited by setting a maximum number of files.

CLR

This clears the file number maximum, setting it to zero (no limit).

This is confirmed by formatting.

FMT (execute formatting)

This formats the SD card using the “RESULTS SAVE FOLDER” setting.

This simultaneously updates the maximum number of files.

NOTE

Example of SD card when formatted with “RESULTS SAVE FOLDER” set to “WORK”

```
\ (root folder)
├── work01
├── work02
├── work03
├── work04
├── work05
├── work06
├── work07
├── work08
├── work09
├── work10
├── work11
├── work12
├── work13
├── work14
├── work15
└── work16
```

Recording data format

Files are recorded on SD cards in CSV format.

The file structure is comprised of header and data sections.

Header section

The header includes device numbers, measurement dates and times, sensor numbers, work numbers and other measurement data, along with judgment results.

Data section

The data section contains measurement data and comparison waveforms.

5. System settings

Recording data example

Measurement data	[Information]		
	Device ID,0	← device number	
	Date,2020/03/31	← measurement date	
	Time,17:47:39	← measurement time	
	Sensor No.,4	← sensor number	
	Work No.,7	← work number	
	Sampling Freq.,25kHz	← sampling frequency	
	X Axis,Time(sec)	← X axis	
	Y Axis,Load(N)	← Y axis	
	X Fullscale,4.00(sec)	← X axis full-scale	
Header section	[Result]		
	Total Judge.,OK	← overall judgment	
	Total Load Judge.,OK	← load judgment	
	Total Disp Judge.,--	← displacement judgment	
	,BAND,ZONE1,ZONE2,ZONE3,ZONE4,ZONE5,	← judgments	
	Hold Method,,Constant,Peak,Bottom,Constant,Inflect,	← judgment methods	
	Load Judge.,OK,OK,OK,OK,OK,OK,	← load judgments	
	Disp Judge.,--,--,--,--,--,	← displacement judgments	
	Hold Point,1.486(sec),0.899(sec),1.296(sec),1.997(sec),3.239(sec),3.845(sec),	← hold points	
	Hold Data,25.96(N),27.96(N),28.95(N),17.22(N),31.67(N),19.18(N),	← hold values	
Judgment results	Zone Start,0.781(sec),0.000(sec),1.080(sec),1.980(sec),2.520(sec),3.060(sec),	← zone starting points	
	Zone End,1.487(sec),0.900(sec),1.800(sec),2.700(sec),3.240(sec),4.032(sec),	← zone ending points	
	Zone Hi Limit,,50.00(N),45.00(N),50.00(N),45.00(N),40.00(N),	← load high limit values	
	Zone Lo Limit,,0.00(N),10.00(N),10.00(N),10.00(N),5.00(N),	← load low limit values	
	Zone Disp. Hi,,	← displacement high limit	
	Zone Disp. Lo,,	← displacement low limit	
	Data section	[Wave Data]	
		[X] Time(sec),[Y] Load(N),Bandwave(Hi),Bandwave(Lo)	← data header
		0.000,22.62,,	← sampling data follows this
		0.001,22.62,,	
:			
0.779,27.18,,			
0.781,27.20,18.47,35.47			
0.783,27.23,18.47,35.47			
0.784,27.25,18.48,35.48			
0.786,27.27,18.49,35.49			
:			
4.028,40.57,,			
4.030,40.69,,			

Judgment method

Constant (constant judgment)
 Sample
 Peak
 Bottom
 P-P (peak-to-peak)
 Average
 Maximum
 Minimum
 Inflect (inflection point)

5-3-5. SERIAL COMM.

PORT SELECTION

Select the port to use for transmission.
 USB: USB port under the recording media slot cover
 D-SUB: RS-232C connector on the back of the unit

COMMUNICATION MODE

Select the data transmission format.
 TD FORMAT/TD FORMAT (BCC)/CONTINUOUS TX

The remaining setting items are RS-232C communication settings.

Set these according to the device used for transmission.

5-3-6. TEST & INFO

STATIC STRAIN DISP.

Set whether to show the input signal with the strain amount unit (μ ST).

Use when checking sensor output and unsteadiness in indicator values, including for sensors and cables, and when making adjustments for discrepancies.

NOTE

Static strain is shown using the 1-gauge method with a gauge factor of 2.0.

When using a sensor with a common gauge factor of 2.0, there is a relationship of $1 \text{ mV/V} = 2000 \mu\text{st}$.

SENSOR INTERRUPTION

Check for interruptions and show the result on the display. If the possibility of an interruption is detected, the location of the possible interruption will be shown in red. Interruptions can occur not only in strain gauges, but also in load cell cables. Connectors might not be connected properly and wiring might also be incorrect.

EXT. TERMINAL CHECK

Input terminal

Depending on the input signal, LOW (ON with yellow indicator) or HIGH (OFF) is shown.

Output terminal

Output can be turned ON/OFF for the connectors as desired.

Use this when checking output connections.

- Be aware that it will not operate as an indicator while checking.
- See pages 23 and 24 for the signal names that correspond to terminal numbers.

D/A CAL TEST

The output value for the method selected in the D/A output setting can be changed.

The voltage or current shown on the display is output from the D/A.

The D/A output changes each time a setting is changed.

F/W VERSION

This shows the firmware version used by the unit.

F/W UPDATE

This will update the firmware of the unit.

5-3-7. FIELD NETWORK

This settings menu will only be shown if field network (optional) is supported.

Please refer to the operation manual of the supported option for details about the setting menu.

6. Communication functions

6-1. Serial communication

6-1-1. Settings

To open the SERIAL COMM. screen, touch the buttons in the following order on the Home Screen.

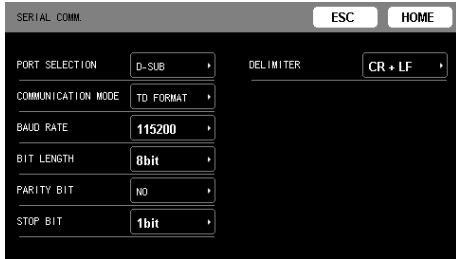

PORT SELECTION

Select the port to use for transmission.

USB: USB port under the recording media slot cover

D-SUB: RS-232C connector on the back of the unit

COMMUNICATION MODE

Select the data transmission format.

BAUD RATE

Set the transmission speed for communication.

BIT LENGTH

Set according to the transmission requirements of connected equipment.

PARITY BIT

Set according to the transmission requirements of connected equipment.

STOP BIT

Set according to the transmission requirements of connected equipment.

DELIMITER

Set according to the transmission requirements of connected equipment.

6-1-1-1. PORT SELECTION



Select the port to use for transmission.

USB

USB port under the recording media slot cover

D-SUB

RS-232C connector on the back of the unit

6-1-1-2. COMMUNICATION MODE

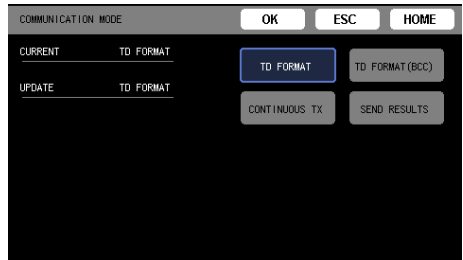

TD FORMAT

This transmission protocol is unique to the TD-9000T.

TD FORMAT (BCC)

This transmission protocol adds checksum (BCC) to the TD FORMAT.

CONTINUOUS TX

This continuously transmits TD Format command code 0005 data.

SEND RESULTS

After measurement stops, this transmits TD Format command code 0007 data.

6-1-2. Command lists

6-1-2-1. Execution

Content	Command No.	Setting item	Note
Digital zero	0000	10	
Clear digital zero	0000	11	
Switch to indicator value screen	0000	17	
Switch to static strain screen	0000	20	
Switch to graph screen	0000	21	
Start measurement	0000	22	
Stop measurement	0000	23	
Reset measurement	0000	24	
Zero balance displacement	0000	25	
Reset software	0000	100	This restarts the system.
Reset to factory settings	0000	101	

6-1-2-2. Polling

Content	Command No.	Setting item
Indicator value polling	0005	See page 80
Status polling	0006	See page 81
Measurement result polling	0007	See page 82
Peak bottom value polling	0008	See page 83
Read hold value	0010	See page 85

6-1-2-3. Waveform and graph

Content	Command No.	Setting item
Acquire measurement waveform	Load measurement waveform sample number	0100 See page 86
	Load measurement waveform	0101 See page 87

6-1-2-4. Settings

Content	Command No.	Setting item	Note
Locking	Lock calibration values (CALIBRATION LOCK)	5201	0: Unlock, 1: Lock
	Lock work (WORK LOCK)	5202	0: Unlock, 1: Lock
	Lock all (ALL LOCK)	5203	0: Unlock, 1: Lock
	Lock touchscreen	5204	0: Unlock, 1: Lock
Backlight setting (LCD BRIGHTNESS)		5301	0 to 3
Backlight time		5302	0 to 255
Language		5303	0: Japanese, 1: English, 2: Chinese, 3: Korean
Internal memory	Save results (SAVING)	5400	0: NO, 1: AUTO SAVE, 2: SAVE ON ERROR
	Overwrite (OVERWRITING)	5401	0: Forbid, 1: Allow
	Delete all	5402	100: Execute
OK counter		5410	100: Reset
NG counter		5411	100: Reset

6. Communication functions

6-1-2-5. INQUIRY

Content	Command No.	Setting item
Device name	5010	"TD-9000T ", 16-byte (characters first, followed by spaces)
Communication options	5012	0: None, 1: EtherNet/IP, 2: CC-Link
Firmware version	5020	"x.xx " 6-byte (characters first, followed by spaces)

6-1-2-6. System

Content	Command No.	Setting item
Device number	5500	0-9999
Beep	5501	0: OFF, 1: KEY, 2: KEY + JUDGE
External measurement signal mode (EXT. START/STOP)	5502	0: Edge, 1: Level
Date & time setting	Format	0: YYYY-MM-DD, 1: DD-MM-YYYY, 2: MM-DD-YYYY
	Date (year, month and day)	YYMMDD
	Time	HHMMSS
Trigger output 1	Output item	0: None, 1: Load, 2: Displacement, 3: OK count, 4: NG count
	Load output threshold (HI)	±99999
	Load output threshold (LO)	±99999
	Displacement output threshold (HI)	±99999
	Displacement output threshold (LO)	±99999
	OK count threshold	0-99999
	NG count threshold	0-99999
Trigger output 2	Output item	0: None, 1: Load, 2: Displacement, 3: OK count, 4: NG count
	Load output threshold (HI)	±99999
	Load output threshold (LO)	±99999
	Displacement output threshold (HI)	±99999
	Displacement output threshold (LO)	±99999
	OK count threshold	0-99999
	NG count threshold	0-99999
Version display (F/W VERSION)	5530	None

6-1-2-6-1. SD card

Content	Command No.	Setting item
Automatic saving (AUTO SAVE)	5600	0: NO, 1: AUTO SAVE, 2: SAVE ON ERROR
Format	5601	1: Execute
Export settings	5602	1: Execute
Import settings	5603	1: Execute
Maximum number of files (MAX NUMB OF FILES)	5605	0 (no maximum) - 5000
Folder for saving results (RESULTS SAVE FOLDER)	5606	0: ROOT, 1: WORK

6-1-2-7. Calibration

6-1-2-7-1. Sensor

Content	Command No.	Setting item
Sensor memory	1000	0: Sensor Memory 1, 1: Sensor Memory 2, 2: Sensor Memory 3, 3: Sensor Memory 4
Sampling rate	1006	0: 5 kHz, 1: 25 kHz
Y axis	1007	0: Load, 1: Load and displacement
X axis	1008	0: Time, 1: Displacement
X axis full scale	1009	0: 80 ms, 1: 170 ms, 2: 400 ms, 3: 800 ms, 4: 2.0 s, 5: 4.0 s, 6: 10.0 s, 7: 30.0 s, 8: 60.0 s, 9: 90.0 s <ul style="list-style-type: none"> ● The definitions change according to the X axis setting (time/displacement).

6-1-2-7-2. Load cell

Content	Command No.	Setting item
Bridge voltage	1001	0: 2.5 V, 1: 5 V, 2: 10 V
Load decimal point position	1002	0: None, 1: 0.0, 2: 0.00, 3: 0.000, 4: 0.0000
Zero point input calibration	1003	-3100 to +3100 (-3.100 to 3.100 mV/V)
Zero balancing	1004	1: Execute
Remote sense	1005	0: Unused, 1: Used
Reset zero balancing	1100	1: Execute
Rated output value (RATED OUTPUT)	1101	100-3200 (0.100-3.200 mV/V)
Rated capacity value (equivalent input)	1102	1-99999
Rated capacity value (actual load)	1103	1-99999
TEDS calibration (TEDS CALIB.)	1104	1: Execute
Enable/disable linearization	1200	0: Disabled, 1: Enabled
Select linearization point	1201	1 to 5
Selection point enabled/disabled	1202	0: Disabled, 1: Enabled
Sensor output value for calibration point	1203	Sensor output value 4 digits (no decimal point) (0 < setting value < rated output value)
Output load value for calibration point (equivalent input)	1204	±99999
Output load value for calibration point (actual load input)	1205	±99999
D/A output setting	1301	0: Voltage, 1: Current
D/A max. voltage	1302	1-10
D/A Zero	1303	±99999
D/A full scale	1304	±99999
Unit shown setting	1401	0: None, 1: N, 2: kN, 3: kPa, 4: MPa, 5: g, 6: kg, 7: ton, 8: mNm, 9: Nm, 10: kNm, 11: dN, 12: Pa, 13: mBar, 14: Bar, 15: m/s ² , 16: Gal, 17: mm
Maximum display value (MAX. DISP. VALUE)	1404	1-99999
Sensor input logic	1405	0: Standard, 1: Reversed
Low-pass filter	2001	0: OFF, 1: 3 Hz, 2: 10 Hz, 3: 30 Hz, 4: 100 Hz, 5: 300 Hz, 6: 1000 Hz
Moving average number (MOVING AVG. NUM.)	2002	0: Disabled, 2-2048: Moving average number
Automatic digital filter (AUTO DIGITAL FILTER)	2003	0: OFF, 1: ON
Digital offset	2303	±19999
Digital zero limit (D/Z LIMIT SETTING)	2302	00000-99999

6. Communication functions

6-1-2-7-3. Displacement sensor

Content	Command No.	Setting item
Reset zero balancing (voltage)	1500	1: Execute
Unit shown	1501	1: μm , 2: mm, 3: cm, 4: m, 5: rad, 6: deg, 0: None
Input mode	1502	0: Pulse, 1: Voltage
Sensor input logic	1503	0: Standard, 1: Reversed
Zero balancing	1504	1: Execute
Displacement decimal point position	1505	0: None, 1: 0.0, 2: 0.00 3: 0.000, 4: 0.0000

6-1-2-7-4. Pulse displacement sensor

Content	Command No.	Setting item
Count number (higher 2 digits)	1600	Higher 2 digits (0–15) ● Set the higher digits followed by the lower digits.
Count number (lower 6 digits)	1601	Lower 6 digits (000000–999999) ● 1–15000000 range with higher
Display value (equivalent input)	1602	00001–99999
Display value (actual load)	1603	00001–99999
Zero position	1604	± 99999
Moving average number (MOVING AVG. NUM.)	1605	0: Disabled, 2–2048: Moving average number
Output phase (AB, A)	1606	0: AB phase, 1: A phase

6-1-2-7-5. Voltage displacement sensor

Content	Command No.	Setting item
Rated output	1610	100–5200 (0.100–5.200 V)
Display value (equivalent input)	1612	00001–99999
Display value (actual load)	1613	00001–99999
Zero position	1614	± 99999
Moving average number (MOVING AVG. NUM.)	1615	0: Disabled, 2–2048: Moving average number
Low-pass filter	1616	0: 10 Hz, 1: 30 Hz, 2: 100 Hz, 3: 300 Hz

6-1-2-7-6. TEDS

Content	Command No.	Setting item
Serial number	6001	0–99999999
Maximum rated capacity	6002	Decimal point position +5 digits
Maximum rated output	6003	Decimal point position +5 digits (mV/V)
Sensor impedance	6004	Decimal point position +5 digits (Ω)
Max. excitation level	6005	Decimal point position +5 digits (V)
Calibration date (CAL. DATE)	6006	Year/month/day (yyyy/mm/dd)
Model number	6007	

6-1-2-8. Work

Content		Command No.	Setting item	
Work number		7000	1–16 (enabled only during manual selection)	
Switch work (WORK SWITCHING)		7001	0: Manually, 1: External input (EXT. INPUT)	
Copy work		7002	0: All, 1–16: Work number	
Measurement trigger	Measurement starting condition	7003	0: EXT. SIGNAL, 1: EXT. & LOAD, 2: EXT. & DISP, 3: LOAD ↑, 4: LOAD ↓, 5: DISPLACE. ↑, 6: DISPLACE. ↓	
	Measurement starting level	7004	±99999	
	Measurement stopping condition	7005	0: EXT. SIGNAL, 1: EXT. or LOAD (EXT. LOAD), 2: EXT. or DISP (EXT. DISP), 3: EXT. or TIME (EXT. TIME)	
	Measurement stopping level	7006	±99999	
Continuous judgment	Enable HHLL	7010	0: Disabled, 1: Enabled	
	HH	7011	±99999	
	HI	7012	±99999	
	LO	7013	±99999	
	LL	7014	±99999	
Band judgment	Enable/Disable waveform comparison (WAVEFORM COMP.)	7100	0: Disabled, 1: Enabled ● If no reference waveform has been set, it will not become enabled.	
Zone judgment	Zone switching	7101	0: Preset, 1: External input	
	Indicator value display (INDICATOR VALUE)	7102	0: Input value, 1–5: Zone number	
Zone settings	Set zone number	7200	1–5 (resets to 1 when power turned on/off) ● The zone set by this can be changed with the following commands.	
	Enable zone	7201	0: Disabled, 1: Enabled	
	Zone range starting point	7202	0–99999	
	Zone range ending point	7203	0–99999	
	Load high limit (HI)	7204	±99999	
	Load low limit (LO)	7205	±99999	
	Displacement high limit (HI)	7206	0–99999 ● This can be set when the X axis is set to displacement.	
	Displacement low limit (LO)	7207	0–99999 ● This can be set when the X axis is set to displacement.	
	Judgment method	7208	0: Constant comparison, 1: Sample, 2: Peak, 3: Bottom, 4: Peak-to-peak, 5: Average value, 6: Maximum, 7: Minimum, 8: Inflection point	
	Maximum/minimum	Load difference (LOAD DIF.)	7211	±99999
		Scaling factor	7212	00–99 (input without decimal point) (0.0–9.9)
		Number of detections (COUNT)	7213	1–10
	Inflection point (INFLECTION)	Detection starting load (STARTING LOAD)	7220	±99999
		Detection extent A (WIDTH A)	7221	1–9999
		Detection extent B (WIDTH B)	7222	1–9999
		Load difference (LOAD DIF.)	7223	±99999
Offset extent (OFFSET)		7224	0–99	

6. Communication functions

6-1-3. Communication protocol

The final characters of responses must be "CR+LF" or "CR".

The final characters are set by the delimiter on the SERIAL COMM. screen (page 72).

TD Format does not use checksums.

TD Format (BCC) adds checksums after data.

NOTE

- The first character in the command must always be "#".
- The final characters of commands must be "CR".
- Since commands 0005, 0006, 0007, 0008, 0010, 0100, 0101, 0110, 0111 and 0112 have unique protocols, they will be described later.
- In the communication examples, the delimiter has been set to "CR+LF".

6-1-3-1. Commands

TD Format

HEX	0x23	0x30	0x30	0x37	0x30	0x30	0x30	0x30	0x30	0x30	0x30	0x30	0x30	0x31	0x0D
ASCII	#	0	0	7	0	0	0	0	0	0	0	0	0	1	CR

Fixed
Command No.
Data

TD Format (BCC)

HEX	0x23	0x30	0x30	0x37	0x30	0x30	0x30	0x30	0x30	0x30	0x30	0x30	0x30	0x31	0x34	0x38	0x0D
ASCII	#	0	0	7	0	0	0	0	0	0	0	0	0	1	4	8	CR

Fixed
Command No.
Data
Checksum

The first character in the command must always be "#".

The data length will be 6 characters.

For the checksum (BCC), all bytes of the fixed, command and data sections are added. Then, the lower 8 bits is split into upper and lower parts of 4 bits each and saved as ASCII.

In the example above, the total of the fixed, command and data sections is as follows.

$$\begin{aligned}
 &0x30+0x30+0x37+0x30+0x30+0x30+0x30+0x30+0x30+0x30+0x30+0x30+0x31 \\
 &= 0x248
 \end{aligned}$$

The checksum is the lower 8 bits, which is 0x48.

6-1-3-2. Responses

The characters at the beginning of the response show the command execution result. The reply is "ACK" if it was completed properly or "NAK" if it ended in an error.

Command execution result when completed properly

TD Format

HEX	0x06	0x30	0x30	0x37	0x30	0x30	0x30	0x0D	0x0A
ASCII	ACK	0	0	7	0	0	0	CR	LF



TD Format (BCC)

HEX	0x06	0x30	0x30	0x37	0x30	0x30	0x30	0x32	0x37	0x0D	0x0A
ASCII	ACK	0	0	7	0	0	0	2	7	CR	LF



When there is response data, it is sent after the command number.
The data length will be 0–9 characters according to the command.
Checksum calculation is the same as in the "Commands" section above.

In the example above, the total of the ID number, command and data is as follows.

$$0 \times 30 + 0 \times 30 + 0 \times 37 + 0 \times 30 + 0 \times 30 + 0 \times 30$$

$$= 0 \times 127$$

The checksum is the lower 8 bits, which is 0×27 .

Command execution result when ended with error

TD Format

HEX	0x15	0x30	0x30	0x37	0x30	0x30	0x30	0x0D	0x0A
ASCII	NAK	0	0	7	0	0	0	CR	LF



TD Format (BCC)

HEX	0x15	0x30	0x30	0x37	0x30	0x30	0x30	0x32	0x37	0x0D	0x0A
ASCII	NAK	0	0	7	0	0	0	2	7	CR	LF



The following are possible causes of errors.

- Improper command number (unsupported command, etc.)
- Overlapping commands issued
- Improper command parameters (setting values)
- Checksum error occurred (when TD Format (BCC) transmission mode is selected)

6. Communication functions

6-1-4. Unique communication protocols

This is an explanation of commands for communicating unique protocols.

In this section, examples of transmission using TD Format (BCC) are given.

To transmit using TD Format, remove the checksum from the transmission examples.

Example responses are only given for command execution results that have completed properly.

Response data values that are not fixed are given as "x" or data names, and symbols are given as "±".

6-1-4-1. Indicator value polling (0005)

If the measurement status of the unit is "Continue", the status and current indicator value will be returned. If the measurement status of the unit is anything else, only the status will be returned.

Command

HEX	0x23	0x30	0x30	0x30	0x30	0x30	0x35	0x32	0x35	0x0D
ASCII	#	0	0	0	0	0	5	2	5	CR

Fixed
Command No.
Checksum

Responses

When the measurement status of the unit is "Continue", and the sensor settings Y axis setting is "LOAD & DISPLACE" or the X axis setting is "DISPLACE".

Byte	0	1	2	3	4	5	6	7	8	9	10-16	17	18-24	25	26	27	28
HEX	0x06	0x30	0x30	0x30	0x30	0x30	0x35					0x2c				0x0D	0x0A
ASCII	ACK	0	0	0	0	0	5	ST1	ST2	ST3	Load value	,	Displacement value	x	x	CR	LF

Fixed
Command No.
Status
Data
Checksum

When the measurement status of the unit is "Continue", and the sensor settings are different from the above

Byte	0	1	2	3	4	5	6	7	8	9	10-16	17	18	19	20
HEX	0x06	0x30	0x30	0x30	0x30	0x30	0x35							0x0D	0x0A
ASCII	ACK	0	0	0	0	0	5	ST1	ST2	ST3	Load value	x	x	CR	LF

Fixed
Command No.
Status
Data
Checksum

When the measurement status of the unit is not "Continue"

Byte	0	1	2	3	4	5	6	7	8	9	17	18	19	20
HEX	0x06	0x30	0x30	0x30	0x30	0x30	0x35						0x0D	0x0A
ASCII	ACK	0	0	0	0	0	5	ST1	ST2	ST3	x	x	CR	LF

Fixed
Command No.
Status
Checksum

Status

ST1 (command status)

0: Ready, 1: Busy, 2: Error, 3: Continuous transmission active

ST2 (measurement status)

0: Continue, 1: Wait, 2: Rec, 3: Stop

ST3 (continuous judgment)

0: NO, 1: OK, 2: LL, 3: LO, 4: HI, 5: HH, 6: HL, 7: NG, 8: FULL, 9: OVER

Data

Load value

10: ± sign, 11–16: Load value (including decimal places)

Byte	10	11	12	13	14	15	16
ASCII	±	×	×	×	×	×	×

Displacement value

18: ± sign, 19–24: Displacement value (including decimal places)

Byte	18	19	20	21	22	23	24
ASCII	±	×	×	×	×	×	×

6-1-4-2. Status polling (0006)

This returns the status of the unit.

Command

HEX	0x23	0x30	0x30	0x30	0x30	0x30	0x36	0x32	0x36	0x0D
ASCII	#	0	0	0	0	0	6	2	6	CR

Fixed Command No. Checksum

Response

Byte	0	1	2	3	4	5	6	7	8	9	10	11	12	13	14	15	16	17	18	19	20	
HEX	0x06	0x30	0x30	0x30	0x30	0x30	0x36				0x30	0x30	0x30	0x30						0x0D	0x0A	
ASCII	ACK	0	0	0	0	0	6	CHECK	ST1	ST2	0	0	0	0	SENSOR	WORK			×	×	CR	LF

Fixed Command No. Data Checksum

Data

CHECK (measurement complete condition)

0: No, 1: Check

- This becomes 1 when measurement completes and becomes 0 after reading once.

ST1 (command status)

0: Ready, 1: Busy, 2: Error, 3: Continuous transmission active, 4: Sending results automatically

ST2 (measurement status)

0: Continue, 1: Wait, 2: Rec, 3: Stop

0000 (4 digits fixed to 0)

SENSOR (current sensor value memory number)

1–4 (1 digit)

WORK (current work number)

1–16 (2 digits)

6. Communication functions

6-1-4-3. Measurement result polling (0007)

If the measurement status of the unit is "Stop", the status and current judgment result will be returned. If the measurement status of the unit is anything else, only the status will be returned.

Command

HEX	0x23	0x30	0x30	0x30	0x30	0x30	0x37	0x32	0x37	0x0D
ASCII	#	0	0	0	0	0	7	2	7	CR

Fixed Command No. Checksum

Responses

When the measurement status of the unit is "Stop"

Byte	0	1	2	3	4	5	6	7	8	9	10	11	12	13	14	15	16	17	18	
HEX	0x06	0x30	0x30	0x30	0x30	0x30	0x37							0x2c		0x2c				0x2c
ASCII	ACK	0	0	0	0	0	7	CHECK	ST1	ST2	TOTAL	LOAD	DISP	,	BAND	,	LOAD	DISP	,	

Fixed Command No. Status Judgment Zone 1 judgment

Byte	19	20	21	22	23	24	25	26	27	28	29	30	31	32	33
HEX			0x2c			0x2c			0x2c					0x0D	0x0A
ASCII	LOAD	DISP	,	LOAD	DISP	,	LOAD	DISP	,	LOAD	DISP	x	x	CR	LF

Zone 2 judgment Zone 3 judgment Zone 4 judgment Zone 5 judgment Checksum

When the measurement status of the unit is not "Stop"

Byte	0	1	2	3	4	5	6	7	8	9	17	18	19	20
HEX	0x06	0x30	0x30	0x30	0x30	0x30	0x35						0x0D	0x0A
ASCII	ACK	0	0	0	0	0	5	ST1	ST2	ST3	x	x	CR	LF

Fixed Command No. Status Checksum

Status

CHECK (measurement complete condition)

0: No, 1: Check

- This becomes 1 when measurement completes and becomes 0 after reading once.

ST1 (command status)

0: Ready, 1: Busy, 2: Error, 3: continuous transmission active, 4: sending results automatically

ST2 (measurement status)

0: Continue, 1: Wait, 2: Rec, 3: Stop

Judgment

TOTAL (overall judgment), LOAD (load judgment), DISP (displacement judgment), BAND (band judgment)

0: NO, 1: OK, 2: LL, 3: LO, 4: HI, 5: HH, 6: HL, 7: NG, 8: FULL, 9: OVER

Zone 1-5 judgments

LOAD (load judgment), DISP (displacement judgment)

0: NO, 1: OK, 3: LO, 4: HI, 7: NG

6-1-4-4. Peak & bottom polling (0008)

When there is no data, if the measurement status of the unit is "Continue", the status, peak value and bottom value will be returned. If the measurement status of the unit is anything else, only the status will be returned.

If data is added, the status, peak value and bottom value will be reset.

NOTE

This command returns the peak and bottom values of continuous judgment.

Command

No data

HEX	0x23	0x30	0x30	0x30	0x30	0x30	0x38	0x32	0x36	0x0D
ASCII	#	0	0	0	0	0	8	2	8	CR

Fixed
Command No.
Checksum

Data included

HEX	0x23	0x30	0x30	0x30	0x30	0x30	0x38	0x30	0x30	0x30	0x30	0x30		0x0D
ASCII	#	0	0	0	0	0	8	0	0	0	0	0	CMD	CR

Fixed
Command No.
Data

Data

CMD

0: None, 1: Reset peak value, 2: Reset bottom value, 3: Reset peak and bottom values

Responses

No data

When the measurement status of the unit is "Continue"

Byte	0	1	2	3	4	5	6	7	8	9	10-16	17	18-24	17	18	19	20
HEX	0x06	0x30	0x30	0x30	0x30	0x30	0x38					0x2c				0x0D	0x0A
ASCII	ACK	0	0	0	0	0	8	CHECK	ST1	ST2	PEAK	,	BOTTOM	×	×	CR	LF

Fixed
Command No.
Status
Data
Checksum

When the measurement status of the unit is not "Continue"

Byte	0	1	2	3	4	5	6	7	8	9	10	11	12	13
HEX	0x06	0x30	0x30	0x30	0x30	0x30	0x38						0x0D	0x0A
ASCII	ACK	0	0	0	0	0	8	CHECK	ST1	ST2	×	×	CR	LF

Fixed
Command No.
Status
Checksum

Status

CHECK (measurement complete condition)

0: No, 1: Check

- This becomes 1 when measurement completes and becomes 0 after reading once.

ST1 (command status)

0: Ready, 1: Busy, 2: Error, 3: continuous transmission active, 4: sending results automatically

6. Communication functions

ST2 (measurement status)

0: Continue, 1: Wait, 2: Rec, 3: Stop

Data

PEAK (peak value)

10: \pm sign, 11–16: Load value (including decimal places)

Byte	10	11	12	13	14	15	16
ASCII	\pm	x	x	x	x	x	x

BOTTOM (bottom value)

18: \pm sign, 19–24: Load value (including decimal places)

Byte	18	19	20	21	22	23	24
ASCII	\pm	x	x	x	x	x	x

Data included

See the communication protocol responses (page 79).

6-1-4-5. Read hold value (0010)

If the measurement status of the unit is "Stop", the status and hold value will be returned. If the measurement status of the unit is anything else, an error (NAK) will be returned.

Command

HEX	0x23	0x30	0x30	0x30	0x30	0x31	0x30	0x30	0x30			0x0D
ASCII	#	0	0	0	0	1	0	START	STOP	,	,	CR

Fixed
Command No.
Data
Checksum

Data

START

Measurement result that starts transmission
 0: Band judgment, 1–5: Zone number

STOP

Measurement result that ends transmission
 0: Band judgment, 1–5: Zone number

NOTE

- The transmission order is Band judgment, Zone 1 judgment, Zone 2 judgment, Zone 3 judgment, Zone 4 judgment, Zone 5 judgment.
- The judgments will be separated by commas.

Responses

Example of measurement result response when the measurement status of the unit is "Stop" (START: 0, STOP: 1)

Byte	0	1	2	3	4	5	6	7	8–26	27	28–46	47	48	49	50	
HEX	0x06	0x30	0x30	0x30	0x30	0x31	0x30	0x2c		0x2c					0x0D	0x0A
ASCII	ACK	0	0	0	0	1	0	,	Load, displacement	,	Load, displacement	x	x	CR	LF	

Fixed
Command No.
Band judgment
Zone 1 judgment
Checksum

Band/zone judgment format

Byte	+0	+1	+2	+3	+4	+5	+6	+7	+8	+9	+10	+11	+12	+13	+14	+15	+16	+17	+18
HEX		0x2c								0x2c		0x2c							
ASCII	J_L	,	±	x	x	x	x	x	x	,	J_D	,	±	x	x	x	x	x	x

Load value (including decimal places)
Time or displacement value* (including decimal places)

*This is time (ms) if the X axis is a time setting or a displacement value if the X axis is a displacement setting

J_L (load judgment), J_D (displacement judgment)

0: NO, 1: OK, 2: LL, 3: LO, 4: HI, 5: HH, 6: HL, 7: NG, 8: FULL, 9: OVER

When the measurement status of the unit is not "Stop"

Byte	0	1	2	3	4	5	6
HEX	0x15	0x30	0x30	0x31	0x30	0x0D	0x0A
ASCII	NAK	0	0	1	0	CR	LF

6. Communication functions

6-1-4-6. Load number of measurement waveform samples (0100)

If the measurement status of the unit is "Stop", the most recent measurement result will be returned. If the measurement status of the unit is anything else, an error (NAK) will be returned.

Command

HEX	0x23	0x30	0x30	0x30	0x31	0x30	0x30	0x32	0x31	0x0D
ASCII	#	0	0	0	1	0	0	2	1	CR

Fixed
Command No.
Checksum

Responses

When the measurement status of the unit is "Stop"

Byte	0	1	2	3	4	5	6	7	8	9	10	11	12	13	14	15	16	17	18
HEX	0x06	0x30	0x30	0x30	0x31	0x30	0x30											0x0D	0x0A
ASCII	ACK	0	0	0	1	0	0	LOAD	TIME	DISP	BAND	NUM				x	x	CR	LF

Fixed
Command No.
Status
Data
Checksum

When the measurement status of the unit is not "Stop"

Byte	0	1	2	3	4	5	6
HEX	0x15	0x30	0x31	0x30	0x30	0x0D	0x0A
ASCII	NAK	0	1	0	0	CR	LF

Status

LOAD, TIME, DISP, BAND

0: Disabled, 1: Enabled

Data

NUM

Number of samples

6-1-4-7. Load measurement waveform (0101)

If the measurement status of the unit is "Stop", the most recent measurement result will be returned. If the measurement status of the unit is anything else, an error (NAK) will be returned.

Command

HEX	0x23	0x30	0x30	0x30	0x31	0x30	0x31		0x2c						0x0D
ASCII	#	0	0	0	1	0	1	TYPE	,	NUM			x	x	CR

Fixed
 Command No.
 Data
 Checksum

Data

TYPE

0: Load, 1: Displacement, 2: Time (in seconds)

NUM

Number of samples

NOTE

The sample numbers start at 0 and increases by one each time sampling occurs.
Data will not be transferred when 0000 is specified.

Responses

When the measurement status of the unit is "Stop"

Initial data

Byte	0	1	2	3	4	5	6	7	8	9	10	11	12	13
HEX	0x06	0x30	0x30	0x30	0x31	0x30	0x31							
ASCII	ACK	0	0	0	1	0	1	±	x	x	x	x	x	x

Fixed
 Command No.
 Data for sample number 0 (no decimal point)

Middle data

Byte	+1	+2	+3	+4	+5	+6	+7
HEX							
ASCII	±	x	x	x	x	x	x

Data (no decimal point)
 Transmit results in order until sample number NUM-2

Last data

Byte	+1	+2	+3	+4	+5	+6	+7	+8	+9	+10	+11
HEX										0x0D	0x0A
ASCII	±	x	x	x	x	x	x	x	x	CR	LF

Data for sample number NUM-1 (no decimal point)
 Checksum

When the measurement status of the unit is not "Stop"

Byte	0	1	2	3	4	5	6
HEX	0x15	0x30	0x31	0x30	0x31	0x0D	0x0A
ASCII	NAK	0	1	0	1	CR	LF

6. Communication functions

6-1-4-8. TEDS command format

Command numbers 6001–6006 are transmitted in this format.

Data is fixed to 8 characters. If the data lacks 8 characters, each opening will be filled with a “0”.

Command

Example of TEDS maximum rated capacity (6002)

HEX	0x23	0x30	0x31	0x36	0x30	0x30	0x32	0x32	0x39	0x0D
ASCII	#	0	1	6	0	0	2	2	9	CR



Response

Example of TEDS maximum rated capacity (6002)

HEX	0x06	0x30	0x31	0x36	0x30	0x30	0x32	0x32	0x30	0x30	0x32	0x30	0x30	0x30	0x30	0x41	0x44	0x0D	0x0A
ASCII	ACK	0	1	6	0	0	2	2	0	0	2	0	0	0	0	A	D	CR	LF



Data

The decimal point position is 2, so the rated capacity is 200.00.

6-1-4-9. Maximum rated capacity (6002), maximum rated output (6003) and sensor impedance (6004) data formats

Byte	+0	+1	+2	+3	+4	+5	+6	+7
HEX								
ASCII	POS	x	x	x	x	x	x	x

Data (no decimal point)

POS (decimal point position)

0: None, 1: 0.0, 2: 0.00 3: 0.000, 4: 0.0000

6-1-5. Timing

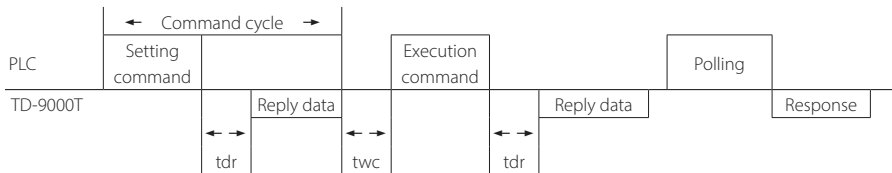

tdr: 5000ms maximum command response

twc: 30ms minimum command interval

7-1. Setting menu list

SETTINGS	(page 65)
LOCK STATUS	(page 65)
LANGUAGE	
CALIB. & SYSTEM	(page 66)
INTERNAL MEMORY	
OK/NG COUNTERS	
SYSTEM	
SENSOR	
WORK	(page 44)

7-1-2. SENSOR

SENSOR	(page 29)
SENSOR MEMORY	
SAMPLING RATE	
Y AXIS	
X AXIS	
X AXIS FULL SCALE	
D/A OUTPUT SETTING	
D/A MAX. VOLTAGE	
D/A ZERO	
D/A FULL SCALE	
LOAD CELL	
DISPLACE. SENSOR	

7-1-1. SYSTEM

SYSTEM	(page 67)
DEVICE NUMBER	
BEEP	
LCD BRIGHTNESS	
BACKLIGHT TIME	
EXT. START/STOP	
DATE	
TRIGGER OUTPUT	
RESET TO FACTORY SETTINGS	
SD CARD	(page 68)
AUTO SAVE	
FORMAT	(page 69)
RESULTS SAVE FOLDER	
MAX NUM OF FILES	
EXPORT SETTINGS	
IMPORT SETTINGS	
SERIAL COMM.	(page 71)
PORT SELECTION	
COMMUNICATION MODE	
BAUD RATE	
BIT LENGTH	
PARITY BIT	
STOP BIT	
DELIMITER	
TEST & INFO	(page 71)
STATIC STRAIN DISP.	
SENSOR INTERRUPTION	
EXT. TERMINAL CHECK	
D/A CAL TEST	
F/W VERSION	
F/W UPDATE	

7-1-2-1. LOAD CELL

LOAD CELL	(page 40)
UNIT SHOWN	
MAX. DISP. VALUE	
MOVING AVG. NUM.	
LOW-PASS FILTER	
CALIBRATION LOCK	
SENSOR INPUT LOGIC	
REMOTE SENSING	
AUTO DIGITAL FILTER	
DIGITAL OFFSET	
D/Z LIMIT SETTING	
EQUIVALENT CALIB.	(page 33)
BRIDGE VOLTAGE	
RATED OUTPUT	
RATED CAPACITY	
ZERO BALANCING	
UNIT SHOWN	
LINEARIZE CALIB.	
ACTUAL LOAD CALIB.	(page 35)
BRIDGE VOLTAGE	
ZERO BALANCING	
RATED CAPACITY	
UNIT SHOWN	
LINEARIZE CALIB.	
TEDS CALIB.	(page 37)
TEDS CALIB.	
ZERO BALANCING	
UNIT SHOWN	
TEDS DATA DISPLAY	
REWRITE TEDS DATA	
RESTORE TEDS DATA	

7. Setting lists

7-1-2-2. DISPLACE. SENSOR

DISPLACE. SENSOR	(page 41)
UNIT SHOWN	
CALIBRATION LOCK	
INPUT MODE	
SENSOR INPUT LOGIC	
PULSE INPUT	
EQUIVALENT CALIB.	(page 42)
OUTPUT PHASE (AB, A)	
ZERO BALANCING	
COUNT NUMBER	
DISPLAY VALUE	
ZERO POSITION	
MOVING AVG. NUM.	
ACTUAL LOAD CALIB.	(page 43)
OUTPUT PHASE (AB, A)	
ZERO BALANCING	
DISPLAY VALUE	
ZERO POSITION	
MOVING AVG. NUM.	
VOLTAGE INPUT	
EQUIVALENT CALIB.	(page 43)
ZERO BALANCING	
RATED OUTPUT	
DISPLAY VALUE	
ZERO POSITION	
LOW-PASS FILTER	
MOVING AVG. NUM.	
ACTUAL LOAD CALIB.	(page 44)
ZERO BALANCING	
DISPLAY VALUE	
ZERO POSITION	
LOW-PASS FILTER	
MOVING AVG. NUM.	

7-1-3. WORK

WORK	(page 44)
WORK NUMBER	
WORK SWITCHING	
COPY WORK	(page 45)
MEASURE. START.	
COND.	
LEVEL	
MEASURE. STOP.	
COND.	
LEVEL	
CONTINUOUS JUDGMENT	(page 45)
LO	
HI	
LL	
HH	
HHLL	
BAND JUDGMENT	(page 46)
SELECT REF. WAVE	
WAVEFORM COMP.	
ZONE JUDGMENT	(page 56)
ZONE SWITCHING	
INDICATOR VALUE	
Zone number	
ZONE n	
JUDGE. METHOD	
CONSTANT	
SAMPLE	
PEAK	
BOTTOM	
P-P	
AVERAGE	
MAX/MIN	
INFLECTION	
ZONE RANGE	
LOAD HIGH (HI)/LOW (LO)	
DISPLACEMENT (HI)/(LO)	

7-2. Setting value list

7-2-1. SETTINGS

Item	Setting	Format	Default value	Setting range/options
LOCK STATUS	CALIBRATION LOCK	Selection	UNLOCK	UNLOCK, LOCK
	WORK LOCK	Selection	UNLOCK	UNLOCK, LOCK
	ALL LOCK	Selection	UNLOCK	UNLOCK, LOCK, PASSWORD LOCK
LANGUAGE		Selection	Japanese	Japanese, English, Chinese, Korean

7-2-2. CALIB. & SYSTEM

Item	Setting	Format	Default value	Setting range/options
INTERNAL MEMORY	SAVING	Selection	AUTO SAVE	NO, AUTO SAVE, SAVE ON ERROR
	OVERWRITING	Selection	ALLOW	ALLOW, FORBID
	DELETE ALL	Selection		EXECUTE
OK/NG COUNTERS		Selection		RESET ALL, RESET ONLY OK, RESET ONLY NG

7-2-3. SYSTEM

Item	Setting	Format	Default value	Setting range/options
DEVICE NUMBER		Input	0000	0000-9999
BEEP		Selection	KEY	OFF, KEY, KEY+JUDGE
LCD BRIGHTNESS		Selection	LEVEL 3	LEVEL 1-4
BACKLIGHT TIME		Input	0	0-255 sec
EXT. START/STOP		Selection	EDGE	EDGE, LEVEL
DATE		Input		2000-2099 (year)
Date format		Selection	yyyy-mm-dd	yyyy-mm-dd, dd-mm-yyyy, mm-dd-yyyy
RESET TO FACTORY SETTINGS		Selection		
SD CARD	AUTO SAVE	Selection	NO	NO, AUTO SAVE, SAVE ON ERROR
	FORMAT	Selection		EXECUTE
	EXPORT SETTINGS	Selection		EXECUTE
	IMPORT SETTINGS	Selection		EXECUTE
SERIAL COMM.	PORT SELECTION	Selection	USB	USB, D-SUB
	COMMUNICATION MODE	Selection	TD FORMAT	TD FORMAT, TD FORMAT (BCC), CONTINUOUS TX
	BAUD RATE	Selection	115200	9600, 19200, 38400, 57600, 115200
	BIT LENGTH	Selection	8bit	8bit, 7bit
	PARITY BIT	Selection	NO	NO, ODD, EVEN
	STOP BIT	Selection	1bit	1bit, 2bit
	DELIMITER	Selection	CR + LF	CR + LF, CR

7. Setting lists

7-2-3-1. FORMAT

Item	Setting	Format	Default value	Setting range/options
RESULTS SAVE FOLDER		Selection	ROOT	ROOT, WORK
MAX NUM OF FILES		Input	0 (no limit)	0 (no limit) – 5000
FMT (execute formatting)		Selection		EXECUTE

7-2-4. SENSOR

Item	Setting	Format	Default value	Setting range/options
SENSOR MEMORY		Selection	1	1–4
SAMPLING RATE		Selection	25 kHz	5 kHz, 25 kHz
Y AXIS		Selection	LOAD	LOAD, LOAD & DISPLACE.
X AXIS		Selection	TIME	TIME, DISPLACE.
X AXIS FULL SCALE		Selection	Time: 2.0s	Time: 80 ms*, 170 ms*, 400 ms, 800 ms, 2.0 s, 4.0 s, 10.0 s, 30.0 s, 60.0 s, 90.0 s Displacement: 2000, 4000, 6000, 8000, 10000, 15000, 20000, 30000
D/A OUTPUT SETTING		Selection	VOLTAGE	VOLTAGE, CURRENT
D/A MAX. VOLTAGE		Input	10 V	0–10 V
D/A ZERO		Input	0.00	±99999
D/A FULL SCALE		Input	100.00	±99999
LOAD CELL	UNIT SHOWN	Selection	N	dN, N, kN, g, kg, ton, mN-m, N-m, kN-m, Pa, kPa, MPa, mBar, Bar, m/s ² , Gal, mm, ---
	MAX. DISP. VALUE	Input	110.00	00000–32000
	MOVING AVG. NUM.	Input	16	0, 2–2048
	LOW-PASS FILTER	Selection	100 Hz	3 Hz, 10 Hz, 30 Hz, 100 Hz, 300 Hz, 1000 Hz, Off
	CALIBRATION LOCK	Selection	OFF	ON, OFF
	SENSOR INPUT LOGIC	Selection	STANDARD	STANDARD, REVERSED
	REMOTE SENSING	Selection	UNUSED (4-wire)	USED (6-wire), UNUSED (4-wire)
	AUTO DIGITAL FILTER	Selection	ON	ON, OFF
DIGITAL OFFSET	Input	0.00	00000–99999	
D/Z LIMIT SETTING	Input	999.99	00000–99999	

*80ms and 170ms cannot be selected when the sampling frequency is set to 5 kHz.

7-2-4-1. LOAD CELL

Item	Setting	Format	Default value	Setting range/options
EQUIVALENT CALIB.	BRIDGE VOLTAGE	Selection	2.5 V	2.5 V, 5 V, 10 V
	RATED OUTPUT	Input	3.000 mV/V	0.100–3.200 mV/V
	RATED CAPACITY	Input	100.00	00001–99999
	ZERO BALANCING	Measurement		CALIBRATION
	UNIT SHOWN	Selection	N	dN, N, kN, g, kg, ton, mN·m, N·m, kN·m, Pa, kPa, MPa, mBar, Bar, m/s ² , Gal, mm, ---
LINEARIZE CALIB.	Measurement		CALIBRATION	
ACTUAL LOAD CALIB.	BRIDGE VOLTAGE	Selection	2.5 V	2.5 V, 5 V, 10 V
	ZERO BALANCING	Measurement		CALIBRATION
	RATED CAPACITY	Measurement	100.00	00001–99999
	UNIT SHOWN	Selection	N	dN, N, kN, g, kg, ton, mN·m, N·m, kN·m, Pa, kPa, MPa, mBar, Bar, m/s ² , Gal, mm, ---
	LINEARIZE CALIB.	Measurement		CALIBRATION
TEDS CALIB.	TEDS CALIB.	Measurement		CALIBRATION
	ZERO BALANCING	Measurement		CALIBRATION
	UNIT SHOWN	Selection	N	dN, N, kN, g, kg, ton, mN·m, N·m, kN·m, Pa, kPa, MPa, mBar, Bar, m/s ² , Gal, mm, ---
	TEDS DATA DISPLAY	Selection		EXECUTE
	REWRITE TEDS DATA	Selection		EXECUTE
	RESTORE TEDS DATA	Selection		EXECUTE

EQUIVALENT CALIB.

Item	Setting	Format	Default value	Setting range/options
LINEARIZE CALIB.	LINEARIZE CALIB.	Selection	OFF	ON, OFF
	Selection point	Selection	DISABLE	ENABLE, DISABLE
	DELETE POINT	Execution		Selection
	Output value	Input		0 – rated output value
	Load value	Input		0–99999

ACTUAL LOAD CALIB.

Item	Setting	Format	Default value	Setting range/options
LINEARIZE CALIB.	LINEARIZE CALIB.	Selection	OFF	ON, OFF
	Selection point	Selection	DISABLE	ENABLE, DISABLE
	DELETE POINT	Execution		Selection
	Load input value	Measurement		Current load value
	Load output value	Input		0–99999

7. Setting lists

7-2-4-2. DISPLACE. SENSOR

Item	Setting	Format	Default value	Setting range/options
UNIT SHOWN		Selection	mm	μm, mm, cm, m, rad, deg, ---
CALIBRATION LOCK		Selection	OFF	ON, OFF
INPUT MODE		Selection	PULSE	PULSE, VOLTAGE

PULSE INPUT

Item	Setting	Format	Default value	Setting range/options
EQUIVALENT CALIB.	OUTPUT PHASE (AB, A)	Selection	AB-phase	AB-phase, A-phase
	ZERO BALANCING	Measurement		EXECUTE
	COUNT NUMBER	Input	10000	1–15000000
	DISPLAY VALUE	Input	100.00	00001–99999
	ZERO POSITION	Input	0	
	MOVING AVG. NUM.	Input	0	0, 2–2048
ACTUAL LOAD CALIB.	OUTPUT PHASE (AB, A)	Selection	AB-phase	AB-phase, A-phase
	ZERO BALANCING	Measurement		EXECUTE
	DISPLAY VALUE	Measurement	100.00	00001–99999
	ZERO POSITION	Input	0	
	MOVING AVG. NUM.	Input	0	0, 2–2048

VOLTAGE INPUT

Item	Setting	Format	Default value	Setting range/options
EQUIVALENT CALIB.	ZERO BALANCING	Measurement		EXECUTE
	RATED OUTPUT	Input	5.000	0.100–5.200 V
	DISPLAY VALUE	Input	100.00	00001–99999
	ZERO POSITION	Input	0	
	LOW-PASS FILTER	Selection	300 Hz	10 Hz, 30 Hz, 100 Hz, 300 Hz
	MOVING AVG. NUM.	Selection	16	0, 2–2048
ACTUAL LOAD CALIB.	ZERO BALANCING	Measurement		EXECUTE
	DISPLAY VALUE	Input	100.00	00001–99999
	ZERO POSITION	Input	0	
	LOW-PASS FILTER	Selection	300 Hz	10 Hz, 30 Hz, 100 Hz, 300 Hz
	MOVING AVG. NUM.	Input	16	0, 2–2048

7-2-5. WORK

Item	Setting	Format	Default value	Setting range/options
WORK NUMBER		Selection	1	1-16
WORK SWITCHING		Selection	MANUALLY	EXT. INPUT, MANUALLY
COPY WORK		Selection	ALL	ALL, 1, 2, 3, 4
MEASURE. START.	COND.	Selection	EXT. SIGNAL	EXT. SIGNAL, EXT. & LOAD*, EXT. & DISP*, LOAD ↑, LOAD ↓, DISPLACE. ↑, DISPLACE. ↓
	LEVEL	Input	50.00	
MEASURE. STOP.	COND.	Selection	EXT. SIGNAL	EXT. SIGNAL, EXT. LOAD*, EXT. DISP*, EXT. TIME*
	LEVEL	Input	100.00	
CONTINUOUS JUDGMENT	LO	Input	10.00	
	HI	Input	100.00	
	LL	Input	-30.00	
	HH	Input	200.00	
	HHLL	Selection	HH/LL OFF	HH/LL ON, HH/LL OFF
BAND JUDGMENT	SELECT REF. WAVE	Selection	WAVE SAMPLING	WAVE SAMPLING, WAVE LOADING
	WAVEFORM COMP.	Selection	DISABLE	DISABLE, ENABLE

*An & shows an AND condition and a | shows an OR condition.

ZONE JUDGMENT

Item	Setting	Format	Default value	Setting range/options
ZONE SWITCHING		Selection	PRESET	EXT. INPUT, PRESET
INDICATOR VALUE		Selection	INPUT VAL.	INPUT VAL., ZONE 1, ZONE 2, ZONE 3, ZONE 4, ZONE 5
Zone number		Selection	1	1-5
ZONE n		Selection	DISABLE	ENABLE, DISABLE
JUDGE. METHOD		Selection	CONSTANT	CONSTANT, SAMPLE, PEAK, BOTTOM, P-P, AVERAGE, MAX/MIN, INFLECTION
ZONE RANGE	START	Input	0.000	
	END	Input	2.240	
LOAD HIGH (HI)/LOW (LO)	HIGH (HI)	Input	100.00	
	LOW (LO)	Input	10.00	
DISPLACEMENT (HI)/(LO)	HIGH (HI)	Input	10000	
	LOW (LO)	Input	0	

7. Setting lists

Item	Setting	Format	Default value	Setting range/options
MAX/MIN	MAX/MIN	Selection	MAX	MAX, MIN
	LOAD DIF.	Input	20.00	
	SCALING FACTOR	Input	1.5	
	COUNT	Input	1	
INFLECTION POINT	STARTING LOAD	Input	1.00	
	WIDTH A	Input	0.05	
	WIDTH B	Input	0.05	
	LOAD DIF.	Input	2.0	
	OFFSET	Input	0.00	

8. Error message list

Error message list	Cause	Solution
The parameter is invalid.	A set value is invalid.	Review the setting values.
An unexpected error has occurred.	If this occurs when saving setting values: The SD card has not been read normally because it could not be mounted normally for some reason.	Reformat this SD card with this unit or replace it with a new card that has been formatted by this unit.
No usable files are available.	If this occurs when loading setting values: The root folder of the SD card does not contain saved setting value data.	Insert an SD card that has saved settings or save setting values before conducting this operation.
The Digital Zero Limit is being exceeded. Check the sensor.	The digital zero offset exceeds the digital zero limit setting value.	The sensor might be damaged. If it is not damaged, change the digital zero limit.
A usable TEDS sensor is not connected	A usable TEDS sensor is not connected	Connect a usable TEDS sensor.
The clock has been reset. Set the date and time from the settings menu.	The internal clock was reset because the built-in rechargeable battery became discharged. If this unit is not used for a long time, for example, the built-in rechargeable battery could become discharged, resetting the clock.	Since the internal clock was reset, set the date and time again using the DATE setting. Unintended dates and times will be used in timestamps for measurement results, files created by saving setting values and screen shot files. In addition, file number management will no longer be possible if a maximum number of files for the SD card has been set.
The level and X axis settings are not consistent.	This appears when a start/stop measurement displacement level setting is made when a displacement sensor has not been set for the X axis.	Set displacement for the X axis or do not specify displacement for measurement start/stop levels.
This operation is not possible during measurement.	Settings cannot be changed during measurement (recording).	If measuring, stop or reset. Settings can be changed when the state is "STOP" or "CONTINUE".
The difference between input and output values is 5% or more.	This appears if a LINEARIZE CALIB. setting value that differs from the calibration line by 5% or more is set.	Set the value so that it is less than 5%.
Something is wrong with the sensor output value. Set to less than the rating in ascending order.	This appears if the output value is set to a value smaller than the previous linearization point when conducting linearization calibration using equivalent calibration.	Always set output values in ascending order compared to the linearization points.
Something is wrong with the sensor output value. Increase the actual load within the rating.	This indicates that the set output value is smaller than the previous linearization point output value when conducting linearization calibration using actual load calibration.	Increase the actual load, for example, and set output values in ascending order compared to the linearization points.
Requested work is being executed. (This might take some time.)	This indicates that work is in progress to save this unit's setting values on the SD card or to load setting values from the SD card and apply them to the unit.	Loading setting values can take up to 60 seconds if there are many band judgment waveforms.
Turn off DHCP to change the address.	This appears if changing the IP address or subnet mask is attempted when DHCP is enabled.	Disable DHCP before changing the IP address.
Set between 0 and 255.	This appears if changing the IP address or subnet mask outside the range of 0–255 is attempted.	Set the address within the range of 0–255.
The internal memory was initialized.	This indicates that data stored in the non-volatile memory of the TD-9000T was initialized. This might be shown after updating the firmware.	If this appears for some reason other than the reason described in the Cause column, seek repair because accurate measurement might not be possible.

9. Warranty explanation

- The warranty period for this device is one year from the date of purchase.
- Be aware that repairs will require payment in the following cases even during the warranty period.
 - 1) Malfunction or damage due to misuse
 - 2) Malfunction or damage caused by modifications or repairs conducted by any party other than our or a service person designated by our company
 - 3) Malfunction or damage caused by dropping, transportation or similar handling after product delivery
 - 4) Malfunction or damage caused by fire, earthquake, water, lightning or other natural disaster
 - 5) Malfunction or damage caused by external factors, including power supplies and equipment environmental conditions, that deviate from the operation requirements of this product
 - 6) Malfunction or damage if the product was not purchased from our company or an agent designated by our company
- We offer paid service after the conclusion of the warranty period. For details, please contact the retailer where you purchased the unit or a contact on the back cover of this manual.
- Be aware that our company will bear no responsibility for any secondary damages resulting from the operation of this device or related to data.
- Be aware that our company will bear no responsibility if data recorded by this device is deleted as a result of misoperation or unexpected incident, for example.
- Information is given about products in this manual only for the purpose of example and does not indicate any guarantees against infringements of third-party intellectual property rights and other rights related to them. TEAC Corporation will bear no responsibility for infringements on third-party intellectual property rights or their occurrence because of the use of these products.

10. Specifications

Load	Bridge voltage		DC, 2.5/5/10 V, $\pm 10\%$ (30mA current maximum, can be used with remote sense)
	Signal input range		± 3.2 mV/V
	Equivalent input/ TEDS	Calibration range	0.1 mV/V – 3.2 mV/V
		Calibration precision	Within 0.1% F.S. (when using 1m standard TEAC Ø8, 6-core shielded cable with 350Ω impedance, 10V BV and 3.0mV/V setting)
	Precision	Linearity	Within 0.01% F.S. +1 digit (when input is 3.0 mV/V)
		Zero drift	Within 0.5 $\mu\text{V}/^\circ\text{C}$ (input conversion value)
		Gain drift	Within $\pm 0.005\%$ F.S./ $^\circ\text{C}$
	A/D conversion		24-bit, 5000 times/second, 25000 times/second
	Low-pass filter		Select 3, 10, 30, 100, 300, 1000 Hz(–6 dB/oct) or Off
D/A output		Output with same frequency as A/D conversion, isolated output, ± 1 – ± 10 V output (set in 1V steps) and about 1/59000 resolution (when set to ± 10 V), or 4–20mA current output and about 1/43000 resolution	
TEDS function		IEEE1451.4 class 2 mix mode interface	
Displacement	Pulse	Pulse type	A/B phase or A phase, differential square wave (RS-422 conformance)
		Maximum input frequency	2 MHz
		Maximum count number	15000000
		Power output	+5 V $\pm 10\%$, 500 mA
	Voltage	Input	± 5.2 V
		Low-pass filter	10/30/100/300 Hz
		Power output	DC 12V $\pm 10\%$, 250 mA
Display		4.3" color LCD (480×272)	
Indicator value	Display range	–32000 to 32000	
	Decimal point	Display position selectable	
	Times displayed	4 times/second	
External input and output signals	Input	Differential pulse position sensor (A phase, B phase), force backlight lighting, prevent touchscreen operation, force reset, work switching (4-bit), switch zone, clear results (reset measurement results), enable/disable judgment output, start/stop measurement, zero balance displacement, digital zero Isolated from main unit circuits using a photocoupler	
	Output	Load judgment output (HH, HI, OK, LO, LL), displacement judgment output (HI, OK, LO), load cell error, measurement complete, trigger output (1, 2) Open collector output (isolated from main unit circuits using a photocoupler)	
	RS-232C	RXD, TXD	
Power supply		Rating: 24V DC $\pm 10\%$, 13 W	
Operating temperature range		0°C to 40°C	
Storage temperature range		–20°C to 60°C	
Operating humidity range		85% RH or less (without condensation)	
Applicable standards		CE marking, FCC (Class A), UL61010-1, UKCA marking	
External dimensions (W × H × D)		Approximately 114 mm × 96 mm × 140 mm (without protrusions)	
Weight		About 960 g	

- Specifications and appearance are subject to change without notice.
- Weight and dimensions are approximate.
- Illustrations in this document might differ slightly from production models.

11. External drawings

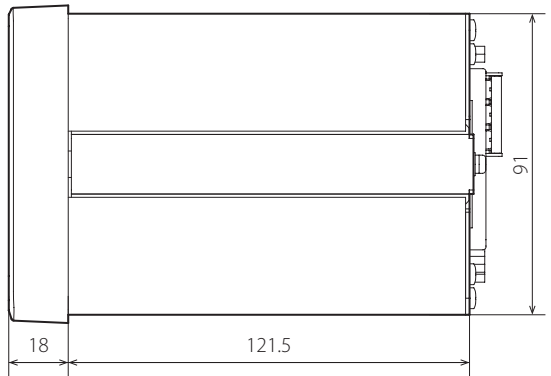
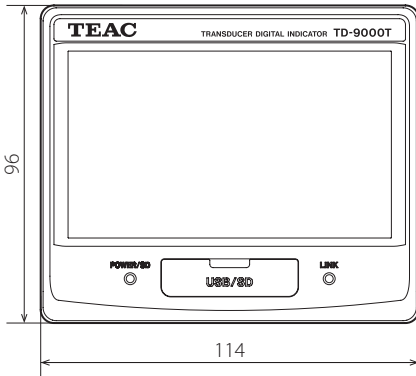
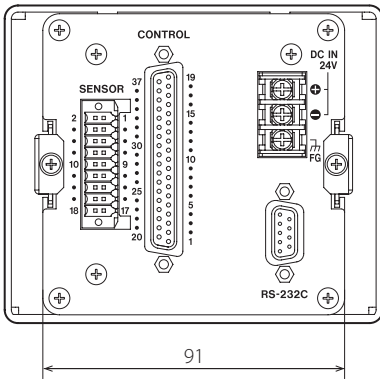

Dimensions in millimeters (mm)

TEAC

TEAC CORPORATION	1-47 Ochiai, Tama-shi, Tokyo 206-8530, Japan	Phone: +81-42-356-9154
TEAC AMERICA, INC.	10410 Pioneer Blvd. Unit #3, Santa Fe Springs, CA 90670, U.S.A.	Phone: +1-323-726-0303
TEAC EUROPE GmbH. (EU Importer)	Bahnstrasse 12, 65205 Wiesbaden-Erbenheim, Germany	Phone: +49-(0)611-7158-349
TEAC UK Limited (UK Importer)	Luminous House, 300 South Row, Milton Keynes, Buckinghamshire, MK9 2FR, UK	Phone: +44-1923-797205
TEAC SALES & TRADING (ShenZhen) CO., LTD.	Room 817, Xinian Center A, Tairan Nine Road West, Shennan Road, Futian District, Shenzhen, Guangdong Province 518040, China	Phone: +86-755-88311561-2
