

# TEAC

## Digital Transducer Indicator Instructions for Use

# TD-700T

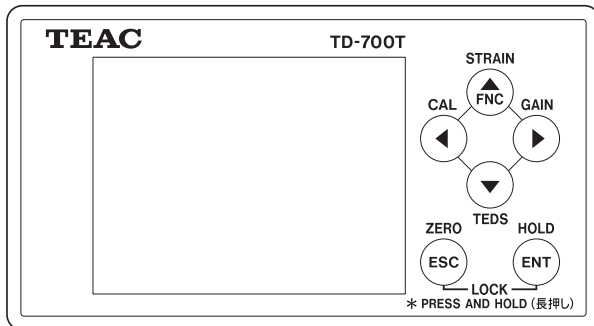

# Introduction

Thank you for purchasing the TD-700T/TD-700T(CCL)/TD-700T(485) Digital Indicator.

Please read this document in its entirety before using the product to get the best performance and ensure safe and proper operation.

The TD-700T(CCL) includes the CC-Link option.

In this manual, "this unit" or "TD-700T" is used when referring to TD-700T, TD-700T(CCL) and TD-700T(485) models.

## ATTENTION

The unit display shown in this manual shows the English interface, but this unit is set to Japanese when sent from the factory. (See "9-7. Languages" to change to English.)

## Features

- Five-digit digital display enables direct reading of physical quantities up to  $\pm 99999$ .
- Support for TEDS sensors makes calibration easy. Automatic calibration is also possible when a TEDS sensor is connected.
- An equivalent input function is included, making sensitivity adjustment without actual loads easy.
- Supports remote sense functions. Even using long cables measurement is possible without losing precision.
- Static strain measurement is possible. Identifying load cell defects and other problems through plastic deformity is easy.
- In addition to high and low limit comparison, this indicators also supports high high limit and low low limit comparison functions.
- Supports a variety of hold functions, including peak hold, bottom hold, peak to peak hold, peak and bottom hold, average hold and these holds with zone designations.
- DIN size supports incorporation with testing devices and manufacturing equipment, for example.
- D/A output according to designated values is a standard feature.
- Product is RoHS compliant
- Optionally supports CC-Link and RS-485 interfaces for easy connection with production lines and other systems.
- Waveform display function allows input signals to be checked as waveforms.

Company names and product names in this document are the trademarks or registered trademarks of their respective owners.

## Disclaimers

Information is given about products in this manual only for the purpose of example and does not indicate any guarantees against infringements of third-party intellectual property rights and other rights related to them. TEAC Corporation will bear no responsibility for infringements on third-party intellectual property rights or their occurrence because of the use of these products.

## Included accessories

If anything is missing or damaged, contact us. (For contact information, see the last page.)

Micro driver (flat-blade)	1
Input and output connector plugs	
B2L 3.50/08/180F SN BK BX or equivalent part	1
B2L 3.50/16/180F SN BK BX or equivalent part	1
AC adapter (GPE012T)	1
● An AC adapter is included with the TD-700T for Japan and North America. No adapter is included for other regions. (The included AC adapter conforms to the safety standards of Japan and North America.)	
Panel attachment fixtures (already attached to unit)	2
DIN rail attachment adapter	1
Power input terminal bank cover (pre-installed on unit)	1

The following additional accessories are included with the TD-700T (CCL).

KEC-NS0604-02 CC-Link connector or equivalent part	1
CC-Link connector cover	1

The following additional accessories are included with the TD-700T (485).

KEC-NS0604-02 RS-485 connector or equivalent part	1
RS-485 connector cover	1
Ferrite core (SFT-59SNB) or equivalent part	1

## Safety information

This document describes the safety instructions for the operation of the digital indicator. Before operating the product, read this document carefully to familiarize yourself with the unit.

 <b>WARNING</b>	Follow the instructions below to avoid risk of serious personal injury and death.
Never use beyond the rated specifications as there is the danger of property damage, injury, fire or electrical shock.	
Never use in flammable gaseous environments including the following locations as there is the danger of explosion. <ul style="list-style-type: none"><li>● Locations containing corrosive or flammable gases</li><li>● Locations near water, oil or subject to chemical splash</li></ul>	
If the product malfunctions (any smoke, odor or noise is present), stop operating the product immediately and unplug the power cord as there is the danger of fire or electrical shock.	
Never attempt to disassemble the product.	
Carefully check connections and wiring before applying power.	
Be sure to ground the product (with ground resistance of 100 Ω or less).	
To allow the operator to immediately shut off the power to the product, install a switch or circuit breaker that complies with both IEC60947-1 and IEC60947-3 requirements near the product. The switch or breaker installed must also indicate that it functions to shut off the power to the unit.	
Do not allow foreign objects such as metal fragments that result from cutting panels, wires or other materials to enter this unit.	
If the unit is dropped or subject to strong impacts, it could break. If this occurs, stop using it and contact the seller from which you purchased it.	
Overvoltage category: II Pollution degree: 2	
If the unit is used in a manner not specified by the manufacturer, the protection provided by the unit may be impaired.	

## Safety information

 <b>CAUTION</b>	Follow the instructions below to avoid risk of personal injury or property damage.
Disconnect the power cord when performing the following.	
<ul style="list-style-type: none"><li>● When wiring or connecting cables to the DC power, load cells, external inputs and outputs or CC-Link or RS-485 terminal connection banks</li><li>● Wiring or connecting cables to terminal blocks</li><li>● Connecting the ground line</li></ul>	
Wait for at least five seconds between turning the unit on and off.	
Never touch the rear panel or connectors while the product is turned on.	
<ul style="list-style-type: none"><li>● When connecting to a power supply, frame ground, signal input/output connector or CC-Link or RS-485 connector, be sure to wire them correctly after confirming the signal names and pin assignment numbers.</li><li>● Use shielded cables for signal input/output cables (load cell, external input/output).</li><li>● Use a CC-Link cable for CC-Link connection.</li><li>● Conduct wiring in a place so that it will not be together or parallel with electrical wiring.</li></ul>	
Avoid use in locations like the following.	
<ul style="list-style-type: none"><li>● Near a power line</li><li>● Where a strong electric or magnetic field is present</li><li>● Where static electricity or noise, (for example, from a relay) is generated</li></ul>	
Do not install in the following environments.	
<ul style="list-style-type: none"><li>● Locations subject to temperatures exceeding the specified temperature and humidity ranges</li><li>● Locations with high salt or iron content</li><li>● Locations subject to direct vibration or shock</li><li>● Outdoor, or locations with an altitude of higher than 2000 m</li><li>● Locations subject to radiant heat from heat sources</li><li>● Locations exposed to dirt and dust</li><li>● Locations subject to severe temperature changes</li><li>● Locations where freezing or condensation might occur</li></ul>	
Do not operate a damaged unit.	
The unit is classified as an open-type (built-in) device and must be installed inside a control panel.	
If the top cover and the panel are dirty, wipe them with a soft cloth lightly dampened with a solution of a neutral detergent and water. Then wipe them again with a slightly damp cloth. DO NOT use a chemically treated dust cloth, paint thinner, or other flammable solvents. Using any of them could damage the coating of the product.	
If the product is used in a manner unintended by the manufacturer, the user's safety may be adversely affected.	
Always attach the DC power terminal bank cover when an electric current is present.	
If subject to electromagnetic waves (from transceivers, mobile phones, amateur wireless transmissions, etc.), use metal pipes for the wiring or make other countermeasures using shielding.	

### Model for USA

#### Supplier's Declaration of Conformity



Model number: TD-700T

Trade name: TEAC

Responsible party: TEAC AMERICA, INC.

Address: 10410 Pioneer Blvd. Unit #1, Santa Fe Springs, California 90670, U.S.A.

Telephone number: 1-323-726-0303

This device complies with Part 15 of the FCC Rules. Operation is subject to the following two conditions: (1) this device may not cause harmful interference, and (2) this device must accept any interference received, including interference that may cause undesired operation.

#### Information

This equipment has been tested and found to comply with the limits for a Class A digital device, pursuant to part 15 of the FCC Rules. These limits are designed to provide reasonable protection against harmful interference when the equipment is operated in a commercial environment. This equipment generates, uses, and can radiate radio frequency energy and, if not installed and used in accordance with the instruction manual, may cause harmful interference to radio communications. Operation of this equipment in a residential area is likely to cause harmful interference in which case the user will be required to correct the interference at his own expense.

#### CAUTION

Changes or modifications not expressly approved by the party responsible for compliance could void the user's authority to operate the equipment.

### Model for Canada

Innovation, Science and Economic Development Canada's Compliance Statement:

This Class A digital apparatus complies with Canadian ICES-003.

Cet appareil numérique de la classe A est conforme à la norme NMB-003 du Canada.

### Model for Europe

#### DECLARATION OF CONFORMITY



This product complies with the European Directives request, and the other Commission Regulations.

#### DECLARACIÓN DE CONFORMIDAD

Este producto cumple con las exigencias de las directivas europeas y con los reglamentos de la Comisión Europea.

#### DÉCLARATION DE CONFORMITÉ

Ce produit est conforme aux directives européennes et aux autres réglementations de la Commission européenne.

#### KONFORMITÄTSERKLÄRUNG

Dieses Produkt entspricht den Anforderungen europäischer Richtlinien sowie anderen Verordnungen der Kommission.

### Model for UK



This product complies with the applicable UK regulations.

#### WARNING

This is a Class A product. In a domestic environment, this product may cause radio interference in which case the user may be required to take adequate measures.

#### ATENCIÓN

Este es un producto de clase A. En un entorno no profesional, este aparato puede producir interferencias de radio, en cuyo caso el usuario será el responsable de tomar las medidas necesarias para solucionarlo.

#### AVERTISSEMENT

Il s'agit d'un produit de Classe A. Dans un environnement domestique, cet appareil peut provoquer des interférences radio, dans ce cas l'utilisateur peut être amené à prendre des mesures appropriées.

#### Warnung

Dies ist eine Einrichtung, welche die Funk-Entstörung nach Klasse A besitzt. Diese Einrichtung kann im Wohnbereich Funkstörungen verursachen; in diesem Fall kann vom Betreiber verlangt werden, angemessene Maßnahmen durchzuführen und dafür aufzukommen.

## Safety information

### DISCLAIMER

TEAC disclaims all warranty, either expressed or implied, with respect to this product and the accompanying written materials. In no event shall TEAC be liable for any damages whatsoever (including, without limitation, damages for loss of business profits, business interruption, loss of business information or other loss) arising out of the use of or inability to use this product.

### Disposing of this product

When disposing of this product, including accessories, consumable parts and related items, follow the regulations of the local, regional and national governments.

#### For European Customers

##### Disposal of electrical and electronic equipment and batteries and/or accumulators

- a) All electrical/electronic equipment and waste batteries/accumulators should be disposed of separately from the municipal waste stream via collection facilities designated by the government or local authorities.
- b) By disposing of electrical/electronic equipment and waste batteries/accumulators correctly, you will help save valuable resources and prevent any potential negative effects on human health and the environment.
- c) Improper disposal of waste electrical/electronic equipment and batteries/accumulators can have serious effects on the environment and human health because of the presence of hazardous substances in the equipment.

- d) The Waste Electrical and Electronic Equipment (WEEE) symbols, which show wheeled bins that have been crossed out, indicate that electrical/electronic equipment and batteries/accumulators must be collected and disposed of separately from household waste.



If a battery or accumulator contains more than the specified values of lead (Pb), mercury (Hg), and/or cadmium (Cd) as defined in the Battery Directive (2006/66/EC, 2013/56/EU), then the chemical symbols for those elements will be indicated beneath the WEEE symbol.



**Pb, Hg, Cd**

- e) Return and collection systems are available to end users. For more detailed information about the disposal of old electrical/electronic equipment and waste batteries/accumulators, please contact your city office, waste disposal service or the shop where you purchased the equipment.

Introduction .....	2	4-10-3. Comparison Setting .....	34
Features .....	2	4-10-4. Hold Function Setting .....	34
Included accessories .....	2	4-10-5. System Settings .....	35
Safety information .....	3	4-10-6. TEDS Settings .....	35
1. Names and functions of parts .....	11	5. Calibration .....	36
1-1. Front panel .....	11	5-1. Procedures shared by all calibration methods .....	37
1-2. Rear panel .....	12	5-1-1. Locking and unlocking calibration values .....	37
1-3. Sensor signal input terminals .....	13	5-1-2. Remote Sense/TEDS .....	38
1-4. D/A output connectors .....	13	5-2. Equivalent input calibration .....	38
1-5. Control signal input terminal .....	14	5-2-1. Bridge Voltage .....	39
1-6. Comparison output connectors .....	14	5-2-2. Rated Output .....	39
1-7. Screen transition diagram .....	15	5-2-3. Rated Capacity .....	39
1-8. Home Screen .....	16	5-2-4. Zero Balancing .....	39
1-8-1. Standard .....	16	5-2-5. D/A Output Mode .....	39
1-8-2. Bar meter display .....	16	5-2-6. D/A Max. Voltage .....	39
1-8-3. Large indicator value .....	16	5-2-7. Select EU .....	39
1-8-4. Graph display .....	18	5-2-8. Cal. Value Lock .....	39
1-8-4-1. Vertical axis .....	19	5-3. Actual Load Calibration .....	40
1-8-4-2. Horizontal axis .....	19	5-3-1. Bridge Voltage .....	40
1-8-4-3. Pausing the graph display .....	19	5-3-2. Zero Balancing .....	40
2. Installation .....	20	5-3-3. Rated capacity (load calibration) .....	40
2-1. Installing in a panel .....	20	5-3-4. D/A Output Mode .....	41
2-2. Removing from a panel .....	21	5-3-5. D/A Max. Voltage .....	41
2-3. Attaching to a DIN rail .....	22	5-3-6. D/A Full Scale .....	41
2-4. Removing from a DIN rail .....	23	5-3-7. Select EU .....	41
3. Making connections .....	23	5-3-8. Max. Disp. Value .....	41
3-1. Connecting with the input and output terminal bank .....	23	5-3-9. Cal. Value Lock .....	41
3-1-1. Sensor signal input connector .....	23	5-4. TEDS calibration .....	42
3-1-2. Control signal input/output connector .....	24	5-4-1. Rated Output/Rated Capacity display .....	42
3-2. Connecting a strain gauge transducer .....	24	5-4-2. Zero Balancing .....	42
3-2-1. About the sensor terminals .....	24	5-4-3. Select EU .....	42
3-2-2. About the Remote Sense function .....	24	5-4-4. Cal. Value Lock .....	42
3-2-3. Notes about bridge voltage (applied voltage) .....	24	5-5. Remote Sense/TEDS .....	43
3-3. Connecting the power supply input terminal .....	25	5-6. Select Min. Grid .....	43
3-3-1. DC power supply .....	25	5-7. Select Disp. Times .....	43
3-3-2. AC power supply .....	26	5-8. Max. Disp. Value .....	43
3-4. Connecting control input terminals .....	26	5-9. Select EU .....	44
4. Settings .....	27	5-10. Sensor input logic .....	44
4-1. Basic operation .....	27	5-11. Zero Balancing .....	44
4-2. Selecting setting values from options .....	28	5-12. Digital Zero .....	45
4-3. Inputting numerical setting values .....	28	6. Condition Setting .....	46
4-4. Changing the decimal point position .....	29	6-1. Filter .....	46
4-5. Lock .....	29	6-1-1. Select LPF .....	46
4-6. Returning to the Home Screen .....	30	6-1-2. Select Num. of Moving Avg. .....	46
4-7. Viewing the version .....	30	6-1-3. Auto Digital Filter .....	46
4-8. Initializing all settings .....	30	6-2. Motion Detect .....	47
4-9. Setting menu list .....	30	6-2-1. Time .....	47
4-9-1. Function Menu .....	30	6-2-2. Width .....	47
4-9-2. Calibration .....	30	6-3. Zero Tracking .....	48
4-9-3. Condition Setting .....	31	6-3-1. Time .....	48
4-9-4. Comparison Setting .....	31	6-3-2. Width .....	48
4-9-5. Hold Function Setting .....	31	6-4. Digital Zero Offset .....	49
4-9-6. System Settings .....	31	6-5. Digital Zero .....	49
4-9-7. TEDS Settings .....	31	6-5-1. Enable Digital Zero .....	49
4-10. Setting value list .....	32	6-5-2. Digital Zero Limit Value .....	49
4-10-1. Calibration .....	32	6-5-3. Clear Digital Zero .....	49
4-10-2. Condition Setting .....	33	6-6. Control Input Check .....	50
		6-7. Judge Output Check .....	50

# Contents

6-8. Static Strain Disp. Mode .....	50
6-9. Select Data Output .....	50
7. Comparison Setting .....	51
7-1. Comp. Value Setting .....	51
7-2. Comp. Pattern Setting .....	51
7-3. Comp. Mode Setting .....	53
7-4. HH LL Limit Enable .....	53
7-5. Hysteresis .....	54
7-6. Judge Signal .....	55
7-7. Comp. Output Pattern .....	55
7-7-1. Standard Output .....	55
7-7-2. Area Output .....	56
7-8. Nearly Zero .....	56
7-9. Bar meter zero position .....	56
8. Hold Function Setting .....	57
8-1. Hold Mode .....	57
8-1-1. Sample and hold .....	58
8-1-2. Peak hold .....	59
8-1-2-1. No zone definition .....	59
8-1-2-2. Zone definition used .....	60
8-1-3. Bottom hold .....	61
8-1-3-1. No zone definition .....	61
8-1-3-2. Zone definition used .....	62
8-1-4. Average hold .....	63
8-1-4-1. No zone definition .....	63
8-1-4-2. Zone definition used .....	64
8-1-5. Peak to peak hold .....	65
8-1-5-1. No zone definition .....	65
8-1-5-2. Zone definition used .....	66
8-1-6. Peak and bottom hold .....	67
8-1-6-1. No zone definition .....	67
8-1-6-2. Zone definition used .....	68
8-1-6-3. Example when the judgment output does not become OK .....	69
8-1-6-4. Example when HH LL Limit is disabled .....	70
8-2. Times of Average .....	71
8-3. Fast Sampling Mode .....	71
8-4. External Hold Mode .....	72
8-5. CLEAR Signal .....	72
8-6. Zone Definition .....	72
8-7. Auto Zero .....	72
9. System Settings .....	73
9-1. Setting Memory .....	73
9-2. D/A Converter .....	73
9-2-1. D/A Zero .....	74
9-2-2. D/A Full Scale .....	74
9-2-3. D/A Output Mode .....	75
9-2-4. D/A Max. Voltage .....	75
9-2-5. D/A CAL TEST .....	75
9-3. Lock .....	75
9-3-1. Cal. Value Lock .....	75
9-3-2. Setting Value Lock .....	76
9-4. Home Screen .....	76
9-5. Brightness .....	76
9-6. Power Save Time .....	76
9-7. Languages .....	77
9-8. Reset to the Factory Settings .....	77
10. TEDS Settings .....	78
10-1. TEDS Data Change .....	78
10-2. Restore TEDS Data .....	79
10-3. TEDS Data .....	80
11. CC-Link Settings .....	81
11-1. CC-Link overview .....	81
11-2. Connections .....	81
11-2-1. CC-Link terminals .....	81
11-2-2. Inserting and removing CC-Link terminal bank .....	81
11-2-3. Connecting the CC-Link terminals .....	81
11-3. Setting value list .....	82
11-4. Settings .....	83
11-4-1. Station Type .....	83
11-4-2. Station Number .....	83
11-4-3. Transmission Speed .....	83
11-4-4. Return Data Format .....	84
11-4-5. Select Memory by .....	84
11-4-6. Save Setting .....	84
11-4-7. Link Status .....	84
11-5. Address map .....	85
Real-time value/hold value format .....	85
Status .....	85
11-5-1. Remote resistor .....	85
Ver.1.10, 4 Stations .....	85
Ver.1.10, 2 Stations .....	86
Ver.1.10, 1 Station .....	86
11-5-2. Remote input and output .....	87
Remote input resistor (TD-700T (CCL) → Master station) .....	87
Remote output resistor (Master station → TD-700T (CCL)) .....	87
Ver.1.10, 4 Stations .....	88
Ver.1.10, 2 Stations .....	89
Ver.1.10, 1 Station .....	90
11-5-3. Remote input and output .....	91
Remote input resistor (TD-700T (CCL) → Master station) .....	91
Remote output resistor (Master station → TD-700T (CCL)) .....	92
11-6. Setting procedures .....	93
11-6-1. Writing Exclusive area values to the device .....	93
11-6-2. Reading, writing and operations using commands in the Common area .....	93
11-6-3. Command .....	94
11-6-4. Error code .....	99
12. RS-485 Settings .....	100
12-1. RS-485 overview .....	100
12-2. Connections .....	100
12-2-1. RS-485 terminals .....	100
12-2-2. Inserting and removing RS-485 terminal bank .....	100
12-2-3. Connecting the RS-485 terminals .....	100
12-3. Setting value list .....	101
12-4. Settings .....	102
12-5. Transmission mode .....	102
12-6. ID number .....	102
12-7. Baud rate .....	102
12-8. Bit length .....	102
12-9. Parity .....	103



12-10. Stop bit .....	103
12-11. Delimiter .....	103
12-12. Save Setting .....	103
12-13. Transmission protocols (TD Format/TD Format (BCC)) .....	104
12-13-1. Commands .....	104
12-13-2. Responses .....	105
12-14. Transmission commands .....	106
12-14-1. Polling (0001) .....	106
12-14-2. Status polling (0002) .....	107
12-14-3. Indicator value polling (0003) .....	108
12-14-4. Setting value writing/execution command format .....	108
12-14-5. Setting value loading command format .....	109
12-14-6. TEDS command format .....	109
12-14-7. Continuous transmission format .....	110
13. Error message list .....	111
14. Warranty explanation .....	112
15. Specifications .....	113
16. External drawings .....	114
17. Block diagram .....	117



# 1. Names and functions of parts

## 1-1. Front panel

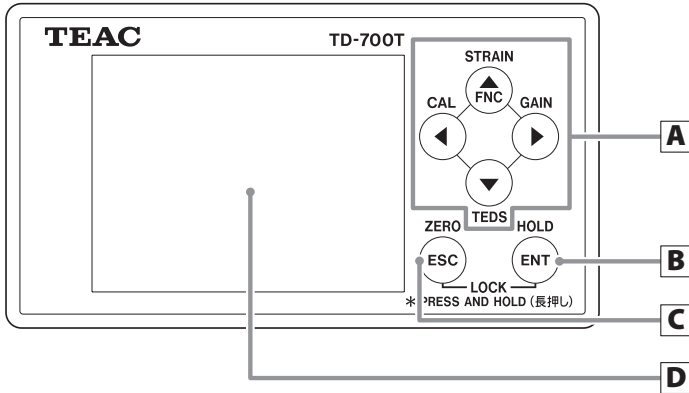

### A Setting buttons

#### STRAIN

Press and hold to open static strain display.

#### CAL

Press and hold to conduct equivalent input calibration.

#### FNC

Press when an indicator value is shown to open the Function Menu.

Press when a setting screen is open to change the function number.

Press when changing a setting value to enable changing the symbol or decimal point.

#### GAIN

Press and hold to conduct actual load calibration.

#### TEDES

When a TEDS sensor is connected, press and hold to open the TEDS calibration screen.



Select setting items and change setting values.



Change the screen shown.

Press when a setting screen is open to select setting items and setting value digits.

### B HOLD/ENT button

Press and hold to start operation of the hold function. Press and hold this button again to disable the hold function.

Press when changing a setting value to confirm the setting item or setting value and move to the next item.

### C ZERO/ESC button

When Cal. Value Lock is OFF, press and hold to use the Zero Balancing function (page 44).

When Cal. Value Lock is ON, press this to forcibly set the indicator value to zero (Digital zero function).

When holding, this button clears the hold value.

Press when a setting screen is open to move up one level.

- Press and hold the ESC and ENT buttons simultaneously to enable or disable the key lock function.

### D Display

This shows indicator and setting values.

If the sensor input is abnormal or the indicator value cannot be shown, one of the following overflow messages will be shown.

–LOAD: A/D converter negative overflow

LOAD: A/D converter positive overflow

–FULL: Display negative overflow (less than the minimum display value)

FULL: Display positive overflow (greater than the maximum display value)

–OVER FULL: Exceeding maximum negative input

OVER FULL: Exceeding maximum input

# 1. Names and functions of parts

## 1-2. Rear panel

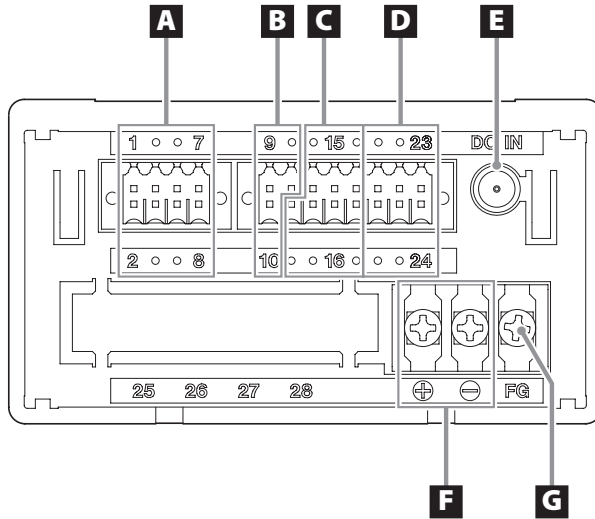

### **A** Sensor signal input terminals

Terminal bank for connecting strain gauge transducers and TEDS sensors.

### **B** D/A output terminals

### **C** Control signal input terminals

### **D** Comparison output terminals

Connect judgment outputs.

### **E** AC adapter jack

Connect the included GPE012T AC adapter.

- See page 26 for information about compatible plugs.



- An AC adapter is included with the TD-700T for Japan and North America. No adapter is included for other regions.  
(The included AC adapter conforms to the safety standards of Japan and North America.)

**⚠ Do not connect both an AC adapter and a power supply to the DC power supply input terminal.**

### **F** DC power supply input terminals

Connect a DC power supply. The voltage range is 12–24 V DC.

### **G** Frame grounding connector

FG connector for DC power supply.

**⚠ Always be sure to connect the FG connector.**

## 1-3. Sensor signal input terminals

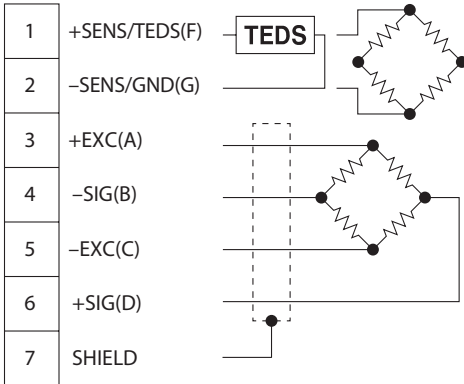

Terminal number	Signal name	Wire color
1	+SENS/TEDS (F)	Orange
2	-SENS/GND (G)	Green
3	+EXC (A)	Red
4	-SIG (B)	Black
5	-EXC (C)	Blue
6	+SIG (D)	White
7	SHIELD (E)	Yellow

- Terminals 1 and 2 are data terminals for use by both remote sense and TEDS sensors. Before connecting the sensor, set which type will be connected in advance using the Remote Sense/TEDS setting on the Calibration menu page. If "Remote Sense disabled/TEDS enabled" is selected, calibration will occur automatically if a sensor with TEDS built-in is connected.
- The wire colors are those that we use in the strain gauge transducers that we make.

## 1-4. D/A output connectors

These can output either voltage or current. They cannot output both at the same time. Set voltage or current in System Settings → D/A Converter → D/A Output Mode (page 75).

Terminal number	Signal name	Explanation
9	V-OUT	D/A voltage output
10	I-OUT	D/A current output
11	COM	D/A output common terminal

- The D/A output is isolated from this unit's circuits.

## 1. Names and functions of parts

### 1-5. Control signal input terminal

Terminal number	Signal name	Explanation
12	CLEAR	This turns on when a hold is cleared in any hold mode except sample hold.  Set whether or not CLEAR Signals are active or inactive in Hold Function Setting → CLEAR Signal.
13	JUDGE	Judgment output using judgment output control signals only functions when this is ON.  Set whether or not JUDGE signals are active or inactive in Comparison Setting → JUDGE Signal.
14	HOLD	Holds function using hold start signals when this is ON.  Disable this by selecting OFF in Hold Function Setting → Hold Mode.
15	D/Z	Sets the indicator value digitally to 0.  This is active when both System Settings → Lock → Cal. Value Lock and Condition Setting → Digital Zero → Enable Digital Zero are set to ON.
16	SEL1	If System Settings → Setting Memory is set to "by signal", the SEL1 and SEL2 terminals can be used to select the active Setting Memory. See "9-1. Setting Memory" on page 73.
17	SEL2	
18	COM	This is the control input signal common terminal.

- The control input signal is isolated from the unit's circuits by a photocoupler.

- Signals are input to each terminal by shorting and opening with 18 COM.  
A current of about 20mA results from shorting.  
When using a transistor, select one with a resistance of at least 10 V and elements that allow the flow of at least 40 mA when on.
- You can confirm the status of the input signal on the screen shown in "6-6. Control Input Check" on page 50.

### 1-6. Comparison output connectors

Terminal number	Signal name	Explanation
19	LL	Low low limit judgment output
20	LO	Low limit judgment output
21	HH	High high limit judgment output
22	HI	High limit judgment output
23	OK	OK judgment output
24	COM	Comparison output common terminal

- The comparison output is isolated from the unit's circuits by a photocoupler.  
Open collector output (NPN, current sync)  
20mA/30V maximum collector current
- For the operation of each signal, see "7. Comparison Setting" on page 51.

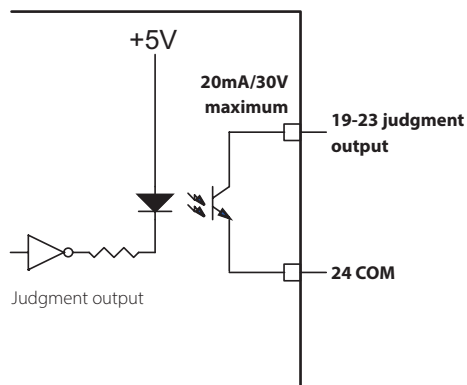

## 1-7. Screen transition diagram

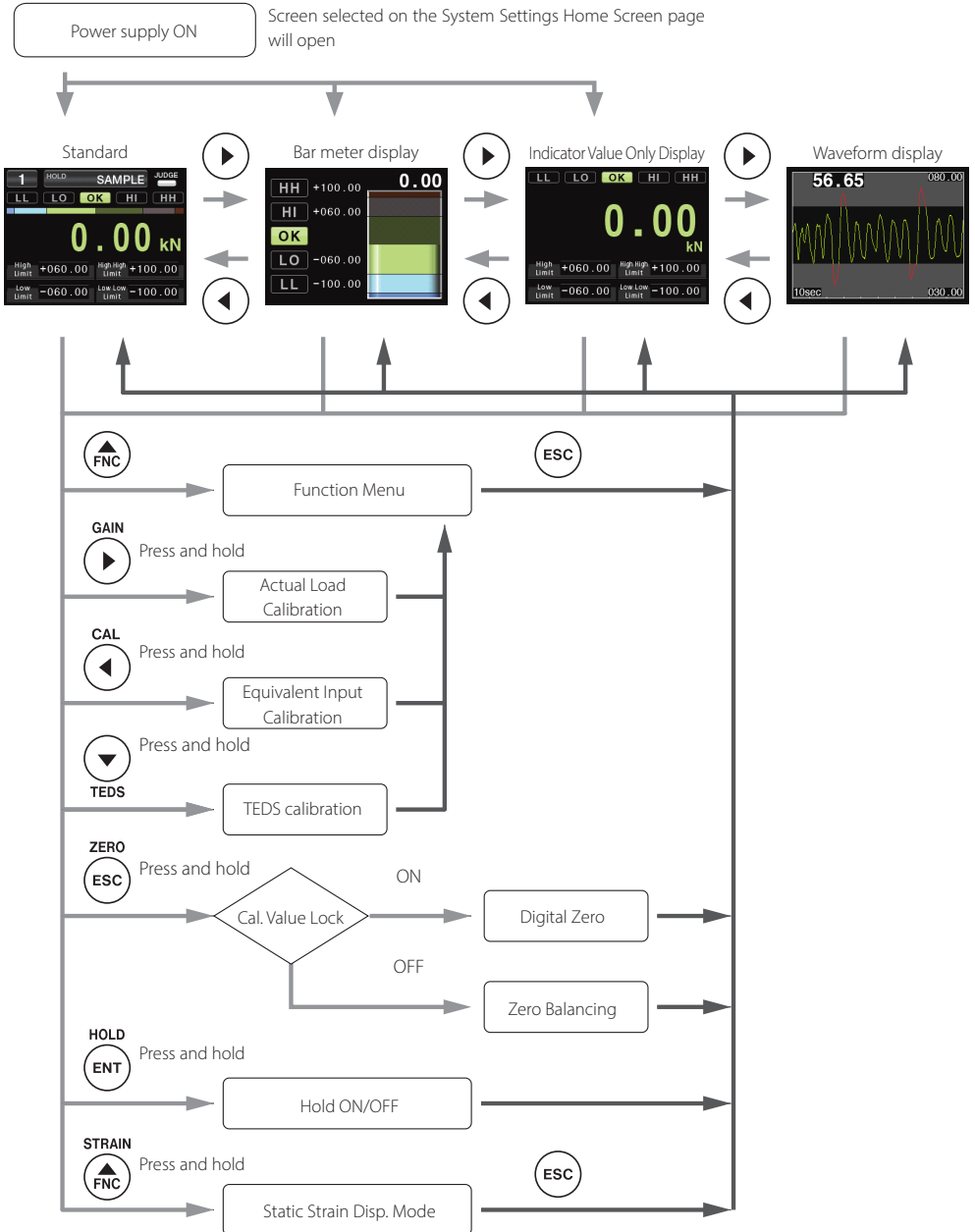

# 1. Names and functions of parts

## 1-8. Home Screen

The screen selected on the System Settings Home Screen page will open when the unit is turned on.

Use the ◀ and ▶ buttons to change screen views.

**NOTE**

The Home Screen will open about 15 seconds after power is supplied to the unit.

### 1-8-1. Standard

When high high limit and low low limit are enabled

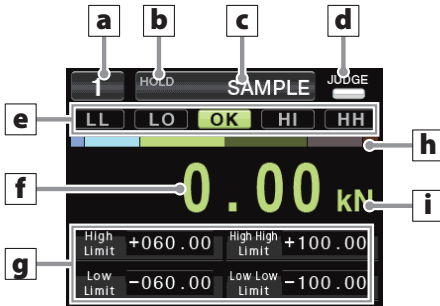

When high high limit and low low limit are disabled

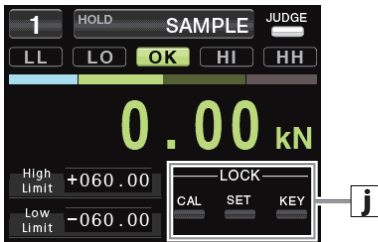

### 1-8-2. Bar meter display

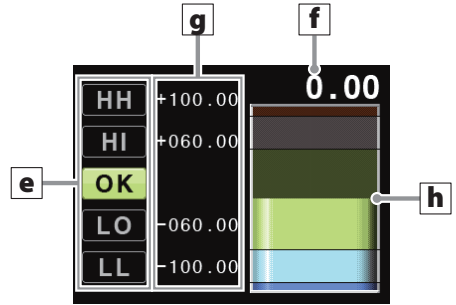

### 1-8-3. Large indicator value

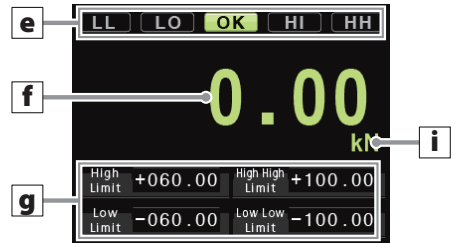



## **a** Memory number

The currently selected memory number is shown.

## **b** HOLD indicator

When the hold function is active, a white indicator appears beneath the word HOLD. When the zone definition hold function is active, a gray indicator appears.

## **c** Hold function setting

The currently selected hold mode is shown.

## **d** JUDGE indicator

When judgment output is active, this indicator appears white.

When Judge Signal is enabled, this appears white if the JUDGE input terminal is ON and black if it is OFF. When Judge Signal is disabled, it is always white.

## **e** Judgment type

### HH/HI

These light to show judgment output operation for indicator values greater than the setting values for the high high and high limits.

### OK

This lights to show OK judgment output operation when the indicator value is equal to or higher than the low limit and equal to or less than the high limit.

### LL/LO

These show judgment output operation for indicator values lower than the setting values for the low low and low limits.

### **NOTE**

Judgment output operation changes according to the Comp. Pattern, Comp. Output Pattern and Hysteresis settings.

The above example is of operation when the Comp. Pattern setting is LL/LO/OK/HH/HH, the Comp. Output Pattern is "Standard Output" and the Hysteresis setting is 0.

## **f** Indicator value

## **g** High limit, low limit, high high limit and low low limit setting values

Each setting value is shown.

If high high limit and low low limit are disabled, the LOCK settings are shown.

## **h** Bar meter

This is an analog representation of the indicator value. The highest value of the bar meter range is set with the Max. Disp. Value setting.

If the low low limit and low limit are zero or higher, the bar meter will show from zero to the maximum display value.

If the low low limit or low limit is less than zero, the bar meter will show zero as the center value and show a range from the maximum display value to negative that value.

### **NOTE**

If the bar meter zero position is at the center, a white line will appear at the zero position.

## **i** Unit

## **j** LOCK settings

This shows the lock status.

CAL: Cal. Value Lock

SET: Setting Value Lock

KEY: Key lock

These do not appear when the high high limit and low low limit are enabled.

### **NOTE**

There are two key lock types.

### **Press and hold ESC + ENT**

This is indicated on the front panel.

This cannot be used to unlock when key lock has been set by pressing and holding ◀+▶.

### **Press and hold ◀+▶**

This is not indicated on the front panel, so it can be used to prevent unlocking when not desired.

Press and hold ◀+▶ to unlock this key lock.

This can also be used to unlock when key lock has been set by pressing and holding ESC+ENT.

# 1. Names and functions of parts

## 1-8-4. Graph display

This graph shows the indicator value as the vertical axis and the time as the horizontal axis.

The current value is plotted at the left edge and the graph scrolls from left to right.

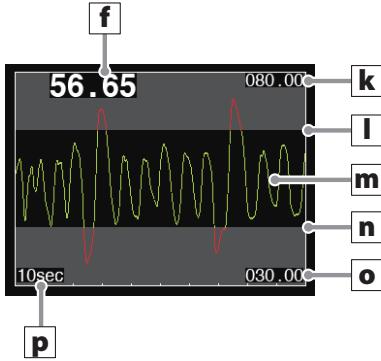

### Appearance when hold function active

The screen will appear as follows when the sample hold, peak hold, bottom hold or average hold function is active.

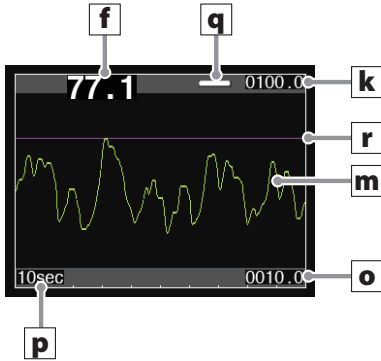

The screen will appear as follows when the peak to peak hold or peak and bottom hold function is active.

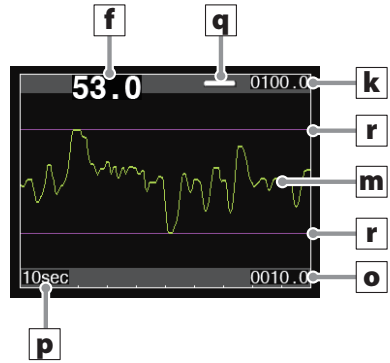

### **k** High limit setting

This shows the high limit value.

- The high high limit is not shown.

### **l** High limit value line

This line corresponds to the high limit value. The area higher than the high limit value line is gray.

### **m** Waveform

Values between the low limit and the high limit are shown in green.

Values above the high limit or below the low limit are shown in red.

### **n** Low limit value line

This line corresponds to the low limit value. The area lower than the the low limit value line is gray.

### **o** Low limit setting

This shows the low limit value.

- The low low limit is not shown.

### **p** Horizontal axis duration

This is the amount of time shown by a single screen width along the horizontal axis.

### **q** Hold indicator

The color shows the hold status.

White: hold activated

Gray: zone definition activated

No indicator: hold not activated

### **r** Hold line

This line corresponds to the hold value. This line is shown in purple.

- Press the ESC button to initialize the hold value.

### **1-8-4-1. Vertical axis**

These values range from 0 to the maximum display (page 43).

### **1-8-4-2. Horizontal axis**

Each time you press the ▼ button, it changes as follows.



### **1-8-4-3. Pausing the graph display**

Press the ENT button to stop the waveform screen display in its current state.

- When paused, the indicator values are shown in green.
- When paused, holds cannot be started or stopped using the front panel buttons.

Press the ENT button again to resume the waveform screen display.

## 2. Installation

Follow these procedures to install the unit in a control panel.

### 2-1. Installing in a panel

- 1** Open a hole in the panel in accordance with this dimensional drawing of the panel installation opening.

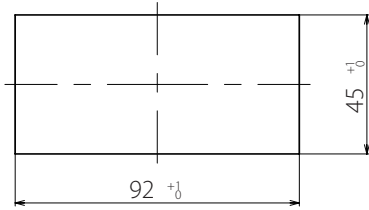

- The recommended panel thickness is 0.8–5 mm.

- 2** Remove the left and right panel attachment fixtures.

While pulling their movable clasps away from the unit, slide each one off the back of the unit.

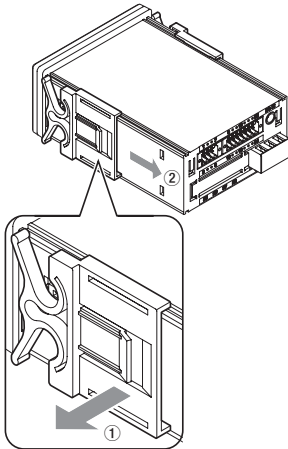

- 3** Insert the unit through the front of the panel.

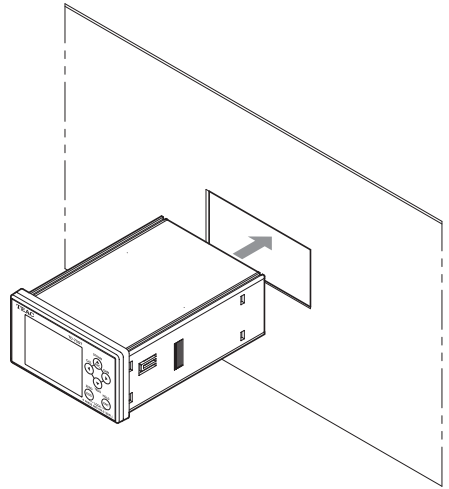

- 4** Attach the left and right panel attachment fixtures that were removed in step 2 to the unit from behind and fix them in place.

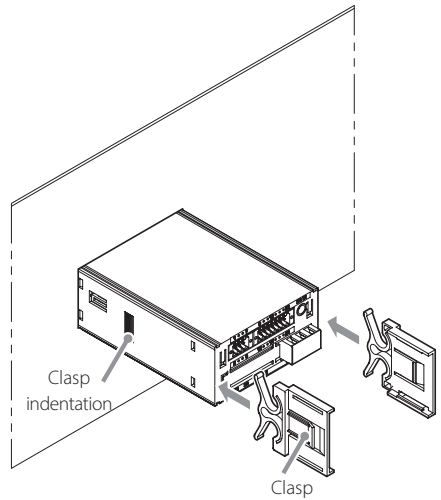

- When pushing the panel attachment fixtures to the panel, attach them horizontally and be sure that they are attached firmly without any give.
- In order to assure that the clasp indentations and the clasps on the panel attachment fixtures are securely connected during use, after attaching them, push the panel attachment fixture clasps toward the unit and confirm that they have latched.
- If the clasp indentations and the clasps on the panel attachment fixtures are not securely connected and left in this state, the clasps could become bent and cease to fit the indentations on the unit.

### ATTENTION

- Do not install the unit in a location that is exposed to direct sunlight, temperatures outside a 0–40°C range or humidity outside a 35–85% range or that is subject to condensation due to extreme temperature variation.
- Do not install in a location with dust or garbage or where electronic components would be exposed to harmful chemicals or corrosive gases, for example.
- When installing inside other equipment, be sure that heat dissipates to prevent the inside of the equipment from exceeding 40°C.
- Do not install in a location that is exposed to excessive vibrations or impacts.

### 2-2. Removing from a panel

#### 1 Remove the left and right panel attachment fixtures.

While pulling their movable clasps away from the unit, slide each one off the back of the unit.

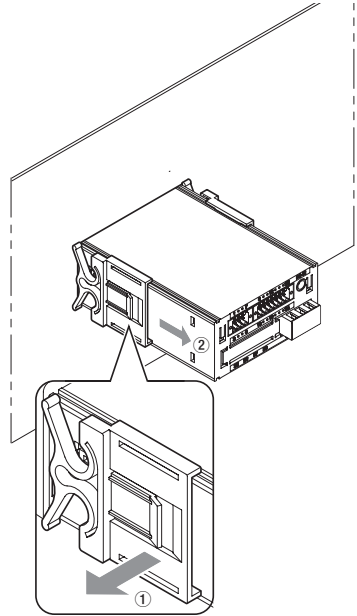

#### 2 After removing the panel attachment fixtures, pull the unit out through the front of the panel.

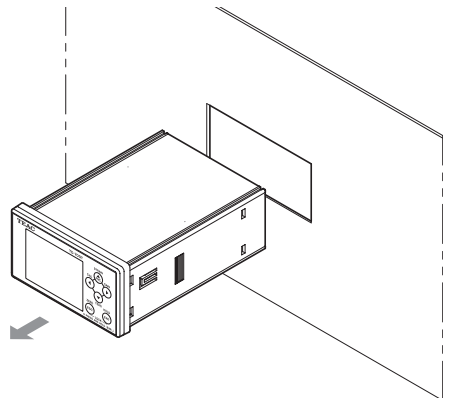

## 2. Installation

### 2-3. Attaching to a DIN rail

#### 1 Insert the rear of the unit into the DIN rail attachment adapter.

You can insert either side up so that it is the orientation desired in step 2.

#### ATTENTION

Be sure that the attachment adapter is attached to the unit firmly without any give.

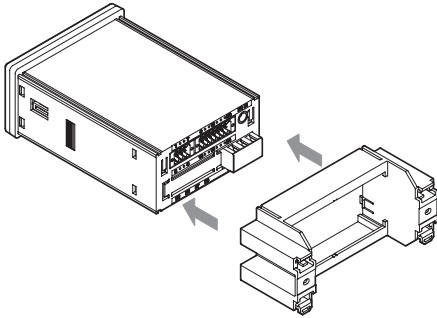

#### ATTENTION

When attaching the adapter to the DIN rail, first hook it to the unmovable clasps and push it in at an angle.

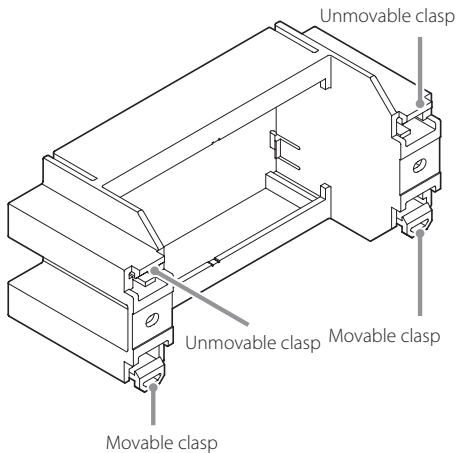

#### 2 Push the adapter on to the DIN rail at an angle and connect it.

If the unmovable clasps face the top of the unit after step 1

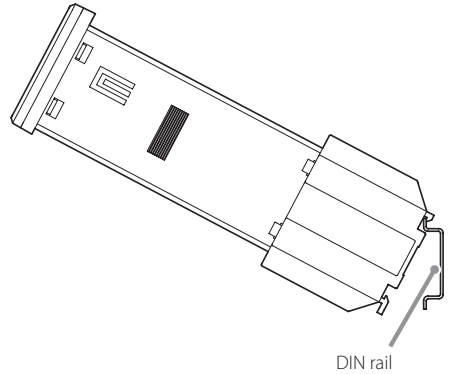

If the unmovable clasps face the bottom of the unit after step 1

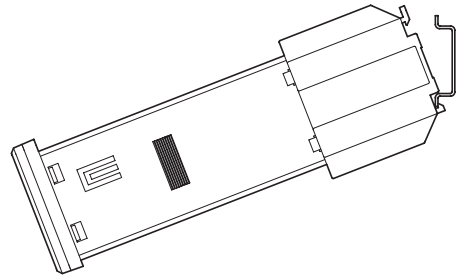

#### ATTENTION

Fix the adapter to the DIN rail firmly and confirm that there is no give.

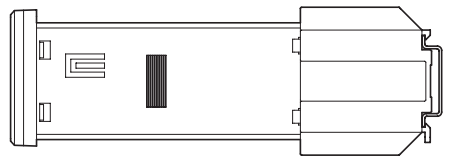

## 2. Installation

### 2-4. Removing from a DIN rail

- 1 Open the movable clasps on the attachment adapter and pull the unit forward to remove it from a DIN rail.

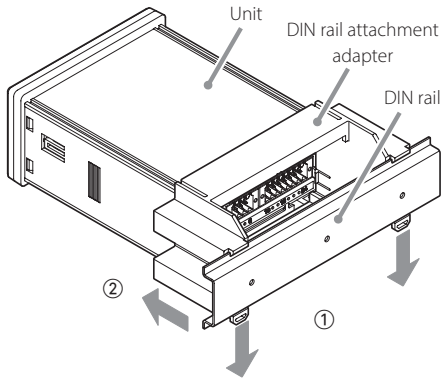

- 2 Open the four clasps on the left and right sides that hold the attachment adapter and the unit together, and remove the attachment adapter from the back of the unit.

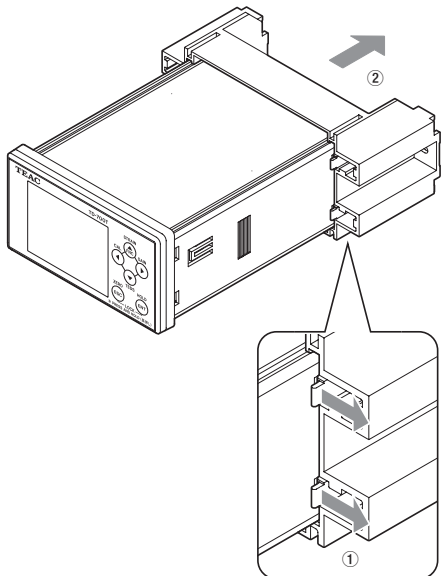

## 3. Making connections

### 3-1. Connecting with the input and output terminal bank

The terminal bank is a 2-piece type.

Use the included micro driver or another tool to connect the included input and output connector plugs.

When using a flat-blade driver other than the one included, make sure the blade is less than 2.5mm wide and 0.4mm thick.

#### CAUTION

Connect only the included input and output connector plugs to the input and output terminal bank. Do not use any other connector, because doing so could make it unsafe.

#### 3-1-1. Sensor signal input connector

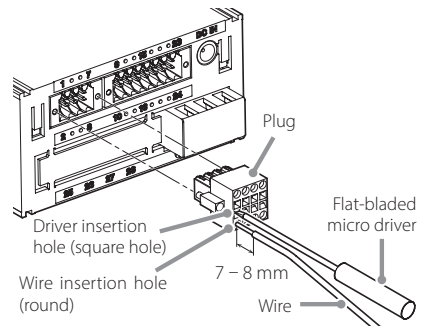

- 1 Remove 7-8 mm of the covering from the wire being connected, and twist it so that the tip does not come apart.

Suitable wiring is 0.13-1.0 mm<sup>2</sup> (28-18 AWG).

- 2 Insert the included flat-bladed micro driver into the square hole above or below the wire insertion hole in the orientation shown in the illustration.

This will open the metal cover over the wire hole.

- 3 Insert the wire into the hole so that the tip does not come apart.

### 3. Making connections

- 4** Remove the flat-bladed screwdriver.
- 5** Pull the wire gently to confirm that it is securely clamped into the hole.
- 6** After it has been connected to the sensor, insert the plug into the indicator and secure it with screws.

#### 3-1-2. Control signal input/output connector

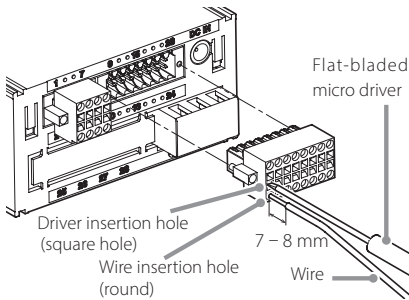

- 1** Remove 7–8 mm of the covering from the wire being connected, and twist it so that the tip does not come apart.  
Suitable wiring is 0.13–1.0 mm<sup>2</sup> (28–18 AWG).
- 2** Insert the included flat-bladed micro driver into the square hole above or below the wire insertion hole in the orientation shown in the illustration.  
This will open the metal cover over the wire hole.
- 3** Insert the wire into the hole so that the tip does not come apart.
- 4** Remove the flat-bladed screwdriver.
- 5** Pull the wire gently to confirm that it is securely clamped into the hole.
- 6** After it has been connected to the sensor, insert the plug into the indicator and secure it with screws.

### 3-2. Connecting a strain gauge transducer

#### 3-2-1. About the sensor terminals

Terminals 1 and 2 in the signal input and output terminal bank are data terminals for use by both remote sense and TEDS sensors.

Before connecting the sensor, set which type will be connected in advance using the Remote Sense/TEDS setting. The default setting is "Remote Sense disabled/TEDS enabled". For details, see "5-5. Remote Sense/TEDS".

#### ATTENTION

- When using a six-wire format (remote sense format), before connecting a sensor, always set "Remote Sense/TEDS" to "Remote Sense enabled/TEDS disabled".
- When using a TEDS sensor or a 4-wire format, set it to "Remote Sense disabled/TEDS enabled".
- Incorrect connections or settings could cause damage to sensors.

#### 3-2-2. About the Remote Sense function

The six-wire format (remote sense format) is a superior connection method that compensates for reduced voltages due to cable length and voltage changes, for example, due to temperature changes.

In systems installed outdoors and other situations where temperature changes are expected, as well as in cases when general precision is desired, for example, we recommend using the six-wire format for remote sensing.

#### 3-2-3. Notes about bridge voltage (applied voltage)

As a reference for setting the bridge voltage, consider that the output from the sensor will increase, and set the maximum voltage in a range that does not exceed the maximum excitation voltage on the sensor test result sheet.

If you set a value that exceeds the sensor's maximum excitation voltage, the sensor could be damaged.

#### ATTENTION

- If the maximum excitation voltage is less than 10 V, set the bridge voltage to 2.5 before connecting.
- In TEDS calibration, when TEDS data is read, if the bridge voltage setting is greater than the maximum excitation voltage recorded in the TEDS memory, the bridge voltage will be changed to a value less than the maximum excitation voltage.



### NOTE

- The default value is 2.5 V.

### Connecting a TEDS sensor or one with 4 wires

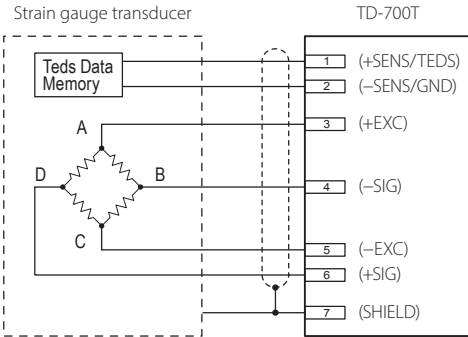

If not using the TEDS function, terminals 1 and 2 can be left open.

### Connecting using 6 wires

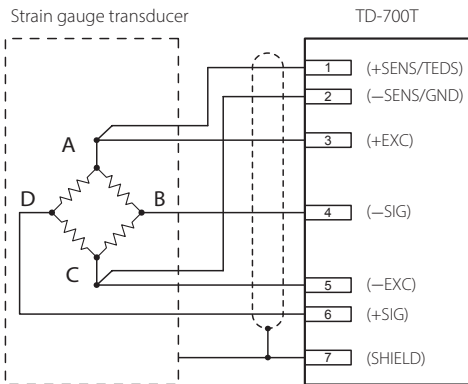

### Usable sensor characteristics

- Output between +SIG and -SIG:  $\pm 3.2$  mV/V or less
- Voltage (current) between +EXC and -EXC: DC 10 V or DC 2.5 V  $\pm 10\%$  (30 mA maximum current)

### WARNING

Do not use this unit for measurements on mains circuits.

## 3-3. Connecting the power supply input terminal

### 3-3-1. DC power supply

The DC power supply input voltage should be 12–24 V. Use a power supply cord that is 0.517–2.081 mm<sup>2</sup> (20–14 AWG). When connecting to the terminal bank, use a solderless terminal (M3, width of 6 mm or less).

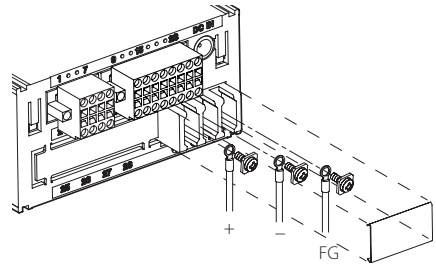

- When the input voltage is DC 12 V, a current of about 0.75 A flows.

### ATTENTION

- If using the unit as a CE compliant product, the power cord must be no more than 3m long.
- Allow the unit to warm up for at least five minutes after supplying power to it.
- The recommended tightening torque for terminals is 0.5 N·m (5.1 kgf·cm).

**⚠ Always attach the cover to the power supply input terminal bank. Failure to do so could result in fire, electric shock or malfunction.**

### 3. Making connections

#### 3-3-2. AC power supply

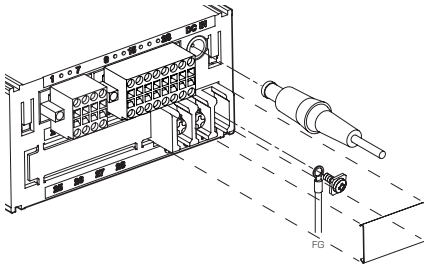

- An AC adapter is included with the TD-700T for Japan and North America. No adapter is included for other regions. (The included AC adapter conforms to the safety standards of Japan and North America.)
- When using an AC power supply in the European region, however, use an adapter that meets EN standards. Specifications for EN standards compliant AC adapter
  - Output: 12 V  $\pm$ 5%, 0.8 A or greater
  - Output plug: 5.5mm outer diameter  
3.3 mm inner diameter
  - Output polarity: center plus
- Insert completely until you hear it click into place before use.
- To prevent the connector from being pulled out and to protect the connector from unnecessary loads, before use fix the adapter cable separately so that it does not hang.
- Allow the unit to warm up for at least five minutes after supplying power to it.

**⚠ Always attach the cover to the power supply input terminal bank. Failure to do so could result in fire, electric shock or malfunction.**

#### 3-4. Connecting control input terminals

Signals are input with the external input circuit when shorted or opened between any control input terminal and the COM terminal. Shorts occur from both contact and non-contact (transistor, TTL open collector).

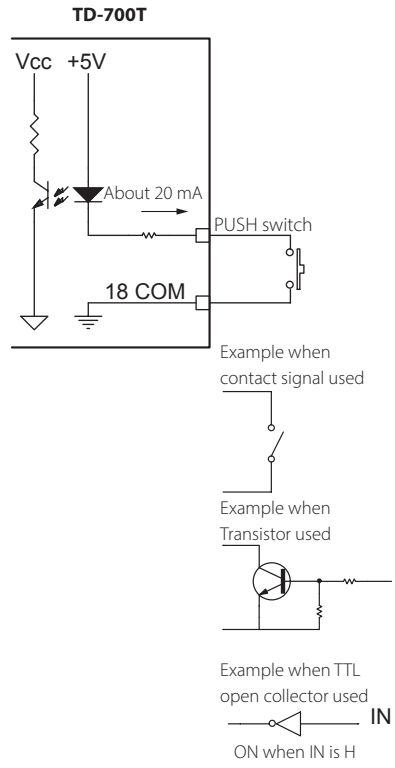

- When external contact is ON, about 20 mA flows. When using a transistor, for example, select one with a resistance of at least 10  $\Omega$  and elements that allow a flow of at least 40 mA when on.
- 18 COM is the common terminal for the 12 CLEAR, 13 JUDGE, 14 HOLD, 15 D/Z, 16 SEL1 and 17 SEL2 control input terminals.
- Do not apply voltage from an external source.

## 4-1. Basic operation

### 1 Press the FNC button to open the Function Menu.

- The buttons at the top right can be used to change the display language.

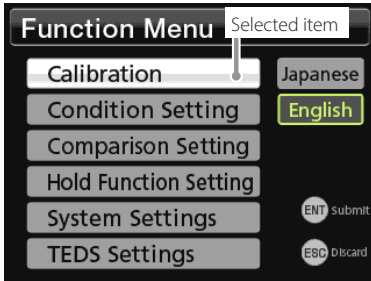

### 2 Use the ▲ and ▼ buttons to select the setting item, and press the ENT button to open the setting screen.

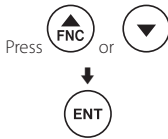

If there are too many selections to be shown on one screen, ▲/▼ will be shown at the top/bottom of the list. Move to the ▲ or ▼ to open the next screen.

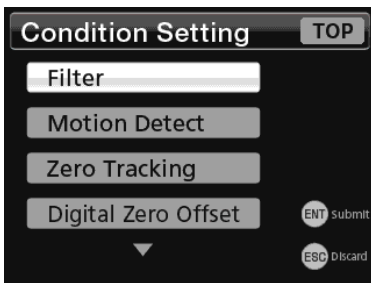

The following screen appears when you select Calibration → Equivalent Input Calibration.

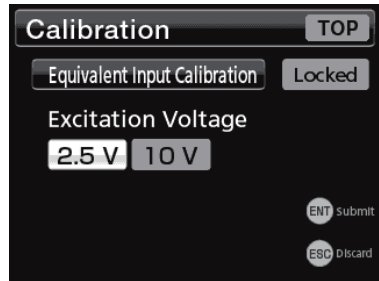

### 3 Changing a series of setting values.

Depending on the menu item, setting screens might appear in a series. When you press the ENT button to confirm a setting value, the next setting screen will open. The setting screens for the lowest level of settings under Calibration, Condition Setting and Hold Function Setting in “4-9. Setting menu list” on page 30 open in series.

If you do not need to change a setting value, press the ENT button to move to the next setting screen.

For example, in the case of Equivalent Input Calibration, the following setting screens appear one after another.

- Excitation Voltage
- Rated Output
- Rated Capacity
- Zero Balancing
- D/A Output Mode
- D/A Max. Voltage
- Select EU
- Cal. Value Lock

After settings are complete, the Function Menu opens.

- Press the ESC button to return to the higher level screen.

## 4. Settings

### 4-2. Selecting setting values from options

The current value has a white background. Other options have gray backgrounds.

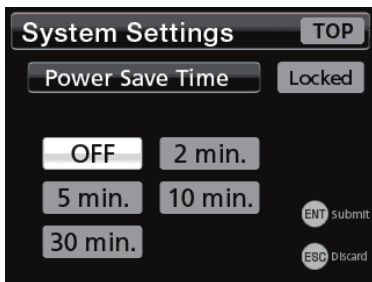

Use the ◀ and ▶ buttons to change the selected option, and press the ENT button. When there are multiple selections, pressing the t button when an option at the right end of a line is selected will select the option at the left end of the next line. A confirmed item will be shown with a green border.

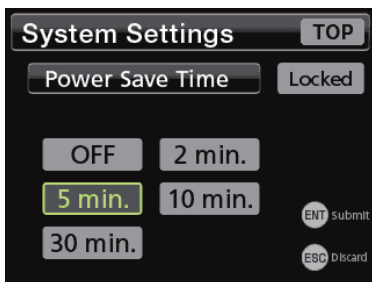

### 4-3. Inputting numerical setting values

The selected digit appears dark with a white background.

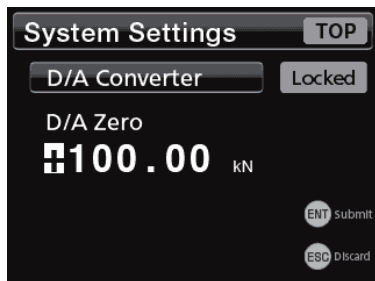

Use the ◀ and ▶ buttons to change the selection, and use the ▲ and ▼ buttons to change the value.

The symbol at the left edge can be switched between + and – by pressing either the ▲ or ▼ button.

When you press the ENT button to confirm, the characters turn green.

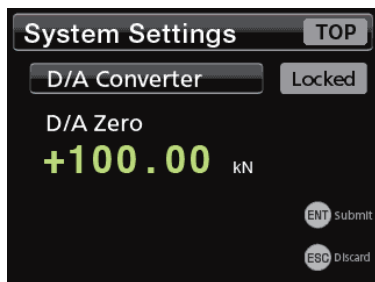

### 4-4. Changing the decimal point position

The decimal point position can only be changed for the Rated Capacity.

- 1 Move the cursor to the decimal point and press the ▲ button to show "0".

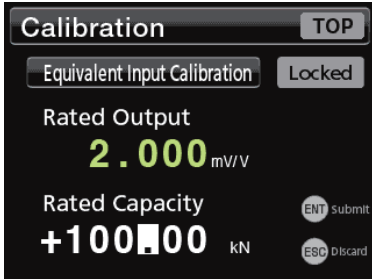

- 2 Move the cursor to the digit where you want to show the decimal point, and press the ▲ or ▼ button until the decimal point is shown.

Each time you press the ▲ or ▼ button, the display changes as follows.



If you press the ENT button when there are two decimal points, an error message appears. Remove one of the decimal points.

- 3 Press the ENT button to confirm the selection.

**ATTENTION**

When a TEDS sensor is connected, if the calibration value lock is not set to ON, the default value will be restored the next time the unit is turned on.

### 4-5. Lock

You can prohibit the changing of calibration and setting values.

When locked, "Locked" appears with a white background at the top right of the setting screen.

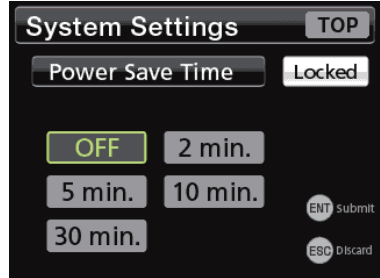

To change a setting value when locked, from the Function Menu, select System Settings → Lock, and disable locking for the calibration or setting values (page 37).

When not locked, "Locked" appears with a gray background at the top right of the setting screen.

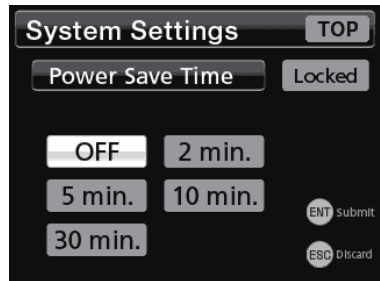

See "4-10. Setting value list" on page 32 for information about lock settings.

## 4. Settings

### 4-6. Returning to the Home Screen

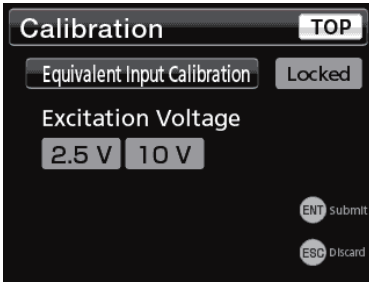

Use the ◀ and ▶ buttons to select TOP, and press the ENT button to return to the Home Screen.

#### IMPORTANT

Always return to the Home Screen to make the unit record setting changes to the nonvolatile memory. The settings will not be retained if the unit is turned off before returning to the Home Screen.

### 4-7. Viewing the version

**1** Press the FNC button to open the Function Menu.

**2** Press and hold ◀ and ▶.

Press the ESC button to return to the Function Menu.

### 4-8. Initializing all settings

You can initialize all the settings of this unit to their factory default values.

- If you want to initialize all the settings except the calibration values in the selected setting value memory, follow the procedures in "9-8. Reset to the Factory Settings" on page 77.

#### ATTENTION

The following procedure will initialize all the settings in the setting value memory, including calibration values.

**1** Follow the procedures in the previous section to show the version.

**2** Press the ENT button once. When "Initialize OK?" appears, press the ENT button again.

- Press the ESC button to cancel.

### 4-9. Setting menu list

#### 4-9-1. Function Menu

Function Menu	
— Calibration	(page 36)
— Condition Setting	(page 46)
— Comparison Setting	(page 51)
— Hold Function Setting	(page 57)
— System Settings	(page 73)
— TEDS Settings	(page 78)

#### 4-9-2. Calibration

Calibration	
— Equivalent Input Calibration	(page 38)
— Bridge Voltage	
— Rated Output/Rated Capacity	
— Zero Balancing	
— D/A Output Mode	
— D/A Max. Voltage	
— Select EU	
— Cal. Value Lock	
— Actual Load Calibration	(page 40)
— Bridge Voltage	
— Zero Balancing	
— Rated Capacity	
— D/A Output Mode	
— D/A Max. Voltage	
— D/A Full Scale	
— Select EU	
— Max. Disp. Value	
— Cal. Value Lock	
— TEDS calibration	(page 42)
— Rated Output/Rated Capacity	
— Zero Balancing	
— Select EU	
— Cal. Value Lock	
— Remote Sense/TEDS	(page 43)
— Select Min. Grid	(page 43)
— Select Disp. Times	(page 43)
— Max. Disp. Value	(page 43)
— Select EU	(page 44)
— Sensor input logic	(page 44)

**4-9-3. Condition Setting**

- Condition Setting (page 46)
  - Filter (page 46)
    - Select LPF
    - Select Num. of Moving Avg.
    - Auto Digital Filter
  - Motion Detect (page 47)
    - Time
    - Width
  - Zero Tracking (page 48)
    - Time
    - Width
  - Digital Zero Offset (page 49)
  - Digital Zero (page 49)
    - Enable Digital Zero
    - Digital Zero Limit Value
    - Clear Digital Zero
  - Control Input Check (page 50)
    - D/Z
    - HOLD
    - JUDGE
    - CLEAR
    - SEL1
    - SEL2
  - Judge Output Check (page 50)
    - Judge Output Check
  - Static Strain Disp. Mode (page 50)
  - Select Data Output (page 50)

**4-9-4. Comparison Setting**

- Comparison Setting
  - Comp. Value Setting (page 51)
  - Comp. Pattern Setting (page 51)
  - Comp. Mode Setting (page 53)
  - HH LL Limit Enable (page 53)
  - Hysteresis (page 54)
  - Judge Signal (page 55)
  - Comp. Output Pattern (page 51)
  - Nearly Zero (page 56)
  - Bar meter zero position (page 56)

**4-9-5. Hold Function Setting**

- Hold Function Setting
  - Hold Mode (page 57)
  - Times of Average (page 71)
  - Fast Sampling Mode (page 71)
  - External Hold Mode (page 72)
  - CLEAR Signal (page 72)
  - Zone Definition (page 72)
  - Auto Zero (page 72)

**4-9-6. System Settings**

- System Settings (page 73)
  - Setting Memory (page 73)
  - D/A Converter (page 73)
    - D/A Zero
    - D/A Full Scale
    - D/A Output Mode
    - D/A Max. Voltage
    - D/A CAL TEST
  - Lock (page 75)
    - Cal. Value Lock
    - Setting Value Lock
  - CC-Link\* (page 81)
    - Station Type
    - Station Number
    - Transmission Speed
    - Return Data Format
    - Select Memory by
    - Save Setting
    - Link Status
  - RS-485\*\* (page 100)
    - Transmission mode
    - ID number
    - Baud rate
    - Bit length
    - Parity
    - Stop bit
    - Delimiter
    - Save Setting
  - Home Screen (page 76)
  - Brightness (page 76)
  - Power Save Time (page 76)
  - Languages (page 77)
  - Reset to the Factory Settings (page 77)

\*These only appear on TD-700T (CCL) units.

\*\*These only appear on TD-700T (485) units.

**4-9-7. TEDS Settings**

- TEDS Settings
  - TEDS Data Change (page 78)
  - Restore TEDS Data (page 79)
  - TEDS Data (page 80)

## 4. Settings

### 4-10. Setting value list

#### 4-10-1. Calibration

Item	Settings	Format	Unit display	Default value	Setting range/options	Calibration value lock	Setting value lock	Setting value memory
Equivalent Input Calibration	Bridge Voltage	Options	V	2.5	2.5, 10	✓		
	Rated Output	Input	mV/V	2.000	0.300–3.200	✓		
	Rated Capacity	Input	Set unit	100.00	00000–99999	✓		
	Zero Balancing				Execute	✓		
	D/A Output Mode	Options		Voltage	Voltage, Current		✓	
	D/A Max. Voltage	Input	V	10V	1–10 (in 1V increments)		✓	
	Select EU	Options		N	dN, N, kN, lbf, klibf, g, kg, sht, ton, mN-m, N-m, kN-m, Pa, kPa, MPa, psi, mBar, Bar, m/s <sup>2</sup> , G, Gal, mm, μst, none	✓		
Cal. Value Lock	Options		OFF	OFF, ON				
Actual Load Calibration	Bridge Voltage	Options	V	2.5	2.5, 10	✓		
	Zero Balancing				Execute	✓		
	Rated Capacity	Input	Set unit	100.00	00000–99999	✓		
	D/A Output Mode	Options		Voltage	Voltage, Current		✓	
	D/A Max. Voltage	Input	V	10V	1–10 (in 1V increments)		✓	
	D/A Full Scale	Input	Set unit	100.00	–99999–99999		✓	
	Select EU	Options		N	dN, N, kN, lbf, klibf, g, kg, sht, ton, mN-m, N-m, kN-m, Pa, kPa, MPa, psi, mBar, Bar, m/s <sup>2</sup> , G, Gal, mm, μst, none	✓		
Max. Disp. Value	Input	Set unit	110.00	00000–99999	✓			
Cal. Value Lock	Options		OFF	OFF, ON				
TEDS calibration	Rated Output	Display	mV/V		0.300–3.200	✓		
	Rated Capacity	Display	Automatic		00000–99999	✓		
	Zero Balancing		Set unit		Execute	✓		
	Select EU	Options		N	dN, N, kN, lbf, klibf, g, kg, sht, ton, mN-m, N-m, kN-m, Pa, kPa, MPa, psi, mBar, Bar, m/s <sup>2</sup> , G, Gal, mm, μst, none	✓		
	Cal. Value Lock	Options		OFF	OFF, ON			
Remote Sense/TEDS		Options		Remote Sense disabled/ TEDS disabled/ Remote Sense disabled/ TEDS enabled	✓			
Select Min. Grid		Options		1	1, 2, 5, 10	✓		
Select Disp. Times		Options	Times	4	4, 6, 10, 20	✓		
Max. Disp. Value		Input	Set unit	110.00	00000–99999	✓		



## 4. Settings

Item	Settings	Format	Unit display	Default value	Setting range/options	Calibration value lock	Setting value lock	Setting value memory
Select EU		Options		N	dN, N, kN, lbf, klbf, g, kg, sht, ton, mN-m, N-m, kN-m, Pa, kPa, MPa, psi, mBar, Bar, m/s <sup>2</sup> , G, Gal, mm, $\mu$ st, none	✓		
Sensor input logic		Options		Standard	Standard, Reversed	✓		

The above items will not be reset when the procedures in "9-8. Reset to the Factory Settings" on page 77 are conducted.

### 4-10-2. Condition Setting

Item	Settings	Format	Unit display	Default value	Setting range/ options/operation	Calibration value lock	Setting value lock	Setting value memory
Filter	Select LPF	Options	Hz	100	3, 10, 30, 100, 300, 1000, none		✓	✓
	Select Num. of Moving Avg.	Options		OFF	OFF, 16, 32, 64, 128, 256, 512, 1024, 2048		✓	✓
	Auto Digital Filter	Options		ON	ON, OFF		✓	✓
Motion Detect	Time	Input	Seconds	1.5	0.0-9.9		✓	✓
	Width	Input	Set unit	000.05	00000-00999		✓	✓
Zero Tracking	Time	Input	Seconds	0.0	0.0-9.9		✓	✓
	Width	Input	Set unit	000.00	00000-00999		✓	✓
Digital Zero Offset		Input	Set unit	000.00	-19999-19999		✓	
Digital Zero	Enable Digital Zero	Options		ON	ON, OFF		✓	
	Digital Zero Limit Value	Input	Set unit	999.99	00000-99999		✓	
	Clear Digital Zero	Options		Skip	Execute, Skip		✓	
Control Input Check	D/Z	Display			LOW, HIGH			
	HOLD	Display			LOW, HIGH			
	JUDGE	Display			LOW, HIGH			
	CLEAR	Display			LOW, HIGH			
	SEL1	Display			LOW, HIGH			
	SEL2	Display			LOW, HIGH			
Judge Output Check		Options			HH, HI, OK, LO, LL			
Static Strain Disp. Mode		Options		OFF	ON, OFF		✓	
Select Data Output		Options		Displayed output	Hold value is output in coordination with display, input is output as is		✓	✓

## 4. Settings

### 4-10-3. Comparison Setting

Item	Settings	Format	Unit display	Default value	Setting range/options	Calibration value lock	Setting value lock	Setting value memory
Comp. Value Setting	High high limit input (HH)	Input		999.99	–99999–99999		✓	✓
	High limit input (HI)	Input		100.00	–99999–99999			
	Low limit input (LO)	Input		50.00	–99999–99999			
	Low low limit input (LL)	Input		000.00	–99999–99999			
Comp. Pattern Setting		Options		LL/LO/OK/ HI/HH	OK/LL/LO/ HI/HH, LL/OK/LO/ HI/HH, LL/LO/OK/ HI/HH, LL/LO/ HI/OK/HH, LL/LO/ HI/HH/OK		✓	✓
Comp. Mode Setting		Options		Compare Always	Compare Always, Compare During Stable, Compare Except Nearly Zero, Compare During Stable Except Nearly Zero, Compare During Held, Disable comparison		✓	✓
HH LL Limit Enable		Options		Disable	Disable, Enable		✓	✓
Hysteresis		Input	Set unit	000.00	00000–99999		✓	✓
Judge Signal		Options		Disable	Disable, Enable		✓	✓
Comp. Output Pattern		Options		Standard Output	Standard Output, Area Output		✓	✓
Nearly Zero		Input	Set unit	001.00	00000–09999		✓	✓
Bar meter zero position		Options		Automatic	Automatic, Left-edge fixed		✓	✓

### 4-10-4. Hold Function Setting

Item	Settings	Format	Unit display	Default value	Setting range/options	Calibration value lock	Setting value lock	Setting value memory
Hold Mode		Options		SAMPLE	OFF, SAMPLE, PEAK, BOTTOM, AVERAGE, PEAK to PEAK, PEAK and BOTTOM		✓	✓
Times of Average		Input	Times	1	1–999		✓	✓
Fast Sampling Mode		Options		OFF	OFF, ON		✓	✓
External Hold Mode		Options		Level	Level, Pulse		✓	✓
CLEAR Signal		Options		Enable	Enable, Disable		✓	✓
Zone Definition		Options		OFF	OFF, ON		✓	✓
Auto Zero		Options		OFF	OFF, ON		✓	✓

### 4-10-5. System Settings

Item	Settings	Format	Unit display	Default value	Setting range/options	Calibration value lock	Setting value lock	Setting value memory
Setting Memory		Options		by menu	by signal, by menu		✓	
		Options		Memory 1	Memory 1, Memory 2, Memory 3, Memory 4		✓	
D/A Converter	D/A Zero	Input	Set unit	000.00	-99999-99999		✓	
	D/A Full Scale	Input	Set unit	100.00	-99999-99999		✓	
	D/A Output Mode	Options		Voltage	Voltage, Current		✓	
	D/A Max. Voltage	Input	V	10V	1-10 (in 1V increments)		✓	
	D/A CAL TEST	Input	Based on D/A output	0V, 4mA	-10 V to +10 V (in 1V increments), 4 mA to 20 mA (in 1mA increments)			
Lock	Cal. Value Lock	Options		OFF	OFF, ON			
	Setting Value Lock	Options		OFF	OFF, ON			
Home Screen		Options		Standard	Standard, Bar meter, Large indicator value		✓	
Brightness		Options		Normal	OFF, Dark, Normal, Bright		✓	
Power Save Time		Options		OFF	OFF, 2 min., 5 min., 10 min., 30 min.		✓	
Languages		Options		Japanese	Japanese, English		✓	
Reset to the Factory Settings		Options		OFF	OFF, ON		✓	

### 4-10-6. TEDS Settings

Item	Settings	Format	Unit display	Default value	Setting range/options	Calibration value Lock	Setting value Lock	Setting value memory
TEDS Data Change	Accept Changing	Input		00000	00000-99999		✓	
	Calibration Date Input	Input	Year: Month: Date	-: -: -	Year/Month/Date		✓	
	Writing Cal. Data				Write		✓	
Restore TEDS Data	Accept Changing	Input		00000	00000-99999		✓	
	Writing Restore Data				Write		✓	
TEDS Data		Display	Rated capacity unit, mV/V, Ω, V, Year/ Month/ Date		Serial number, Rated capacity, Rated output, Bridge Element Impedance, Max. Exc. Level, Calibration Date			

# 5. Calibration

Connecting the unit with a strain gauge transducer and setting how the indicator values will be shown is called "calibration". The following three calibration methods can be used with the unit.

## 1. Equivalent input calibration

This calibration method does not depend on actual loads. It only requires the input of the strain gauge transducer rated output (mV/V) and the rated capacity (value you want shown). Use this to calibrate easily when an actual load cannot be applied.

Examples:

- Weight  
100kN rated capacity, 2.001mV/V rated output
- Pressure  
10.00MPa rated capacity, 2.002mV/V rated output
- Torque  
15.00N-m rated capacity, 2.502mV/V rated output

In this manner, by recording values from test results tables, the gain can be determined automatically and shown.

## 2. Actual Load Calibration

This calibration method measures the values of actual loads on the strain gauge transducer.

By applying an actual load that is as close as possible to the maximum measured value, calibration with less error is possible.

## 3. TEDS calibration

This calibration method uses the strain gauge transducer rated output (mV/V) and rated capacity that are recorded in TEDS memory.

Note, however, that equipment with TEDS memory includes both 1kbit and 4kbit devices, but the unit only supports 4kbit.

## Sensor check before calibrating

After connecting a sensor and providing power, calibration is not possible if the indicator value is unstable or an error appears. If this occurs, turn static strain mode ON (Condition Setting → Static Strain Disp. Mode) and check the indicator value. In this mode, the sensor output itself is shown as a strain amount unit ( $\mu\text{ST}$ ), so input between 0 and  $\pm 3.2$  mV/V will be shown as a value from 0 to  $\pm 6400$ .

## Overview of zero balancing and digital zero functions

### 1. Zero balancing value definition

This is the value for which zero balancing is conducted during the sensor calibration procedures in this chapter.

When Cal. Value Lock is ON, this setting value is defined as the zero balancing value.

### 2. Digital zero (D/Z) value definition

The Digital Zero (D/Z) function that shows zero separately from the zero balancing value can be used only when Cal. Value Lock is ON and Digital Zero is enabled.

The Digital Zero (D/Z) function is not defined when either Cal. Value Lock is OFF or Cal. Value Lock is ON and the Digital Zero function is OFF.

See the following table for details.

The ZERO button function depends on the Cal. Value Lock setting as shown in the table below.

Cal. Value Lock	Enable Digital Zero	ZERO button function
ON	ON	Digital Zero (D/Z)
	OFF	Error
OFF	Undefined	Zero Balancing

A strain gauge transducer should have written test results with contents such as the following.

- Rated capacities: weight, pressure, etc. (unit: kN, MPa, etc.)
- Rated output: voltage (unit: mV/V)
- Linearity: %R.O.
- Hysteresis: %R.O.
- Safe Excitation Voltage (Maximum): V (bridge voltage)
- Input Terminal Resistance:  $\Omega$
- Output Terminal Resistance:  $\Omega$
- Zero balance: %R.O.

- The data necessary for equivalent input calibration are rated capacity and rated output.
- Some of this data is written to the internal memory of the TEDS sensor.

Depending on the setting, the zero value might not be retained when the power is restarted.

Name	When power restarted
Digital zero (D/Z) value	The set zero value is reset, and the zero balancing value is shown.
Zero balancing value	The set zero value is retained.

### ATTENTION

When Cal. Value Lock is set to OFF, digital zero (D/Z) by a CC-Link remote resistor is disabled.

## 5-1. Procedures shared by all calibration methods

The three calibration methods are equivalent input calibration, actual load calibration and TEDS calibration. All the calibration methods have the same procedures before and after calibration. An overview of the calibration procedures is shown below.

### Disable Cal. Value Lock

System Settings → Lock → Cal. Value Lock (select OFF)



### Remote Sense/TEDS selection

Calibration → Remote Sense/TEDS

Terminals 1 and 2 are data terminals for use by both remote sense and TEDS sensors.

Before connecting the sensor, set which type will be connected in advance using the Remote Sense/TEDS setting on the Calibration menu page.



### Calibration

Calibration → Equivalent Input Calibration  
or, Actual Load Calibration  
or, TEDS calibration



### Cal. Value Lock setting

First, we will explain the procedures to be conducted before and after calibration. Then, we will explain the procedures for equivalent input calibration, actual load calibration and TEDS calibration.

### ATTENTION

When calibration is conducted, the "D/A converter" setting will be initialized automatically according to the calibration value.

## 5-1-1. Locking and unlocking calibration values

Usually, the unit is used with Cal. Value Lock set to ON. Before calibration, Cal. Value Lock must be set to OFF. After calibration, set Cal. Value Lock to ON again.

- 1 Press the FNC button to open the Function Menu.

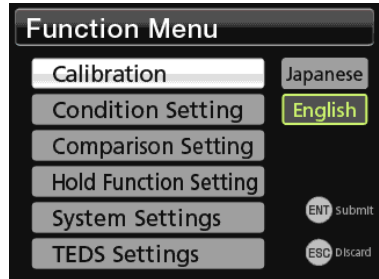

- 2 Use the ▲ ▼ buttons to change the selection, and select in order System Settings → Lock.

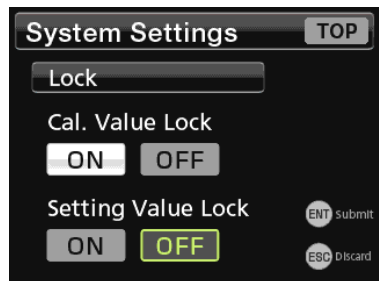
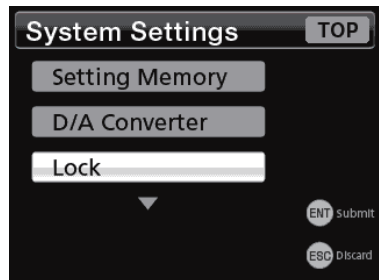

## 5. Calibration

- 3** Use the ◀ ▶ buttons to select OFF or ON.

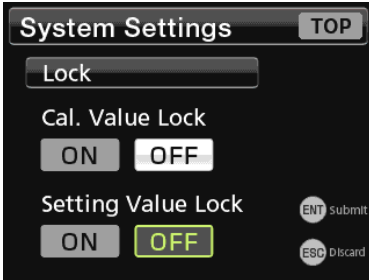

- 4** Press the ENT button to confirm the selection.

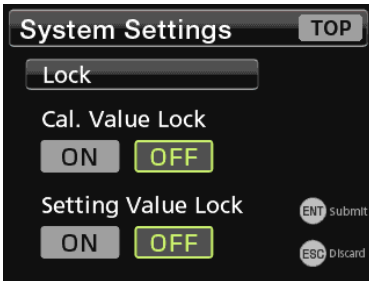

- 5** Press the ESC button to exit setting mode.

### ATTENTION

- The ZERO button function depends on the Cal. Value Lock setting. When Cal. Value Lock is ON, press the ZERO button to use the Digital Zero function. When Cal. Value Lock is OFF, press it to use the Zero Balancing function.
- In order to prevent accidental changes to the calibration value, set Cal. Value Lock to ON after calibration.

### NOTE

See "4-10. Setting value list" on page 32 for information about settings that cannot be changed when Cal. Value Lock is ON.

### 5-1-2. Remote Sense/TEDS

Terminals 1 and 2 are data terminals for use by both remote sense and TEDS sensors.

Before connecting a sensor, confirm the sensor specifications. Furthermore, when using a 6-wire format, set Remote Sense/TEDS to "Remote Sense enabled/TEDS disabled". When using a TEDS sensor or a 4-wire format, set it to "Remote Sense disabled/TEDS enabled".

### 5-2. Equivalent input calibration

This method determines the calibration value by recording rated output and rated capacity values from a test results table. Use this to calibrate easily when an actual load cannot be applied.

An overview of the equivalent input calibration procedures is shown below.

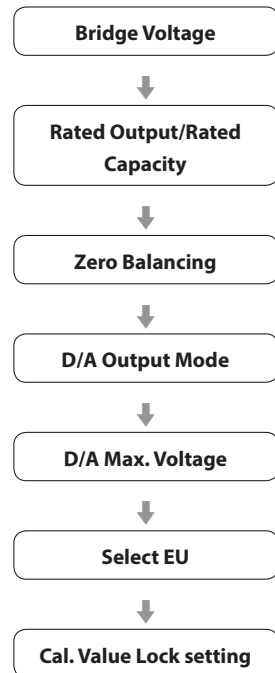

- See "9-2. D/A Converter" on page 73 for information about D/A settings.

### 5-2-1. Bridge Voltage

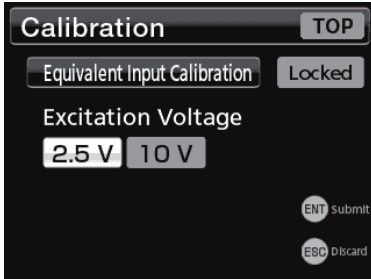

Select the bridge voltage to supply to the strain gauge transducer.

Press the ENT button to change the bridge voltage.

- As a reference for setting the bridge voltage, consider that the output from the sensor will increase, and set the maximum voltage in a range that does not exceed the maximum excitation voltage on the sensor test result sheet.

**ATTENTION**

- If you set a value that exceeds the sensor's maximum excitation voltage, the sensor could be damaged.

**NOTE**

- The default value is 2.5 V.
- In TEDS calibration, when TEDS data is read, if the bridge voltage setting is greater than the maximum excitation voltage recorded in the TEDS memory, the bridge voltage will be changed to a value less than the maximum excitation voltage.

### 5-2-2. Rated Output

Input range: 0.300–3.200 mV/V

Set the rated output of the strain gauge transducer being used.

### 5-2-3. Rated Capacity

Set the rated capacity of the strain gauge transducer being used.

**NOTE**

The decimal point position set here will be used as the indicator value decimal point position.

**ATTENTION**

When using a D/A option, set Rated Capacity to the D/A Full Scale value.

### 5-2-4. Zero Balancing

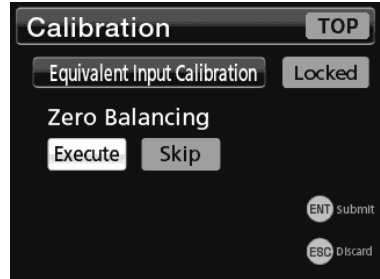

With no load on the sensor, select Execute.

During zero balancing, a pop-up appears to show that it is in progress. When zero balancing completes, the setting screen for the next procedure appears.

To skip zero balancing, select Skip.

- If a calibration error appears, conduct countermeasures according to the error message.

### 5-2-5. D/A Output Mode

Options: Voltage, Current

### 5-2-6. D/A Max. Voltage

Range:  $\pm 1$ – $\pm 10$  (1V increments)

**NOTE**

For information about D/A settings, see "9-2. D/A Converter" on page 73.

### 5-2-7. Select EU

Options: dN, N, kN, lbf, kN-m, N-m, kPa, MPa, psi, mBar, Bar, m/s<sup>2</sup>, G, Gal, mm,  $\mu$ st, none

Select the unit that corresponds to the indicator value.

### 5-2-8. Cal. Value Lock

To prevent unintended changes to the calibration value, Cal. Value Lock should usually be set to ON.

## 5. Calibration

### 5-3. Actual Load Calibration

Calibrate by applying an actual load to the sensor.

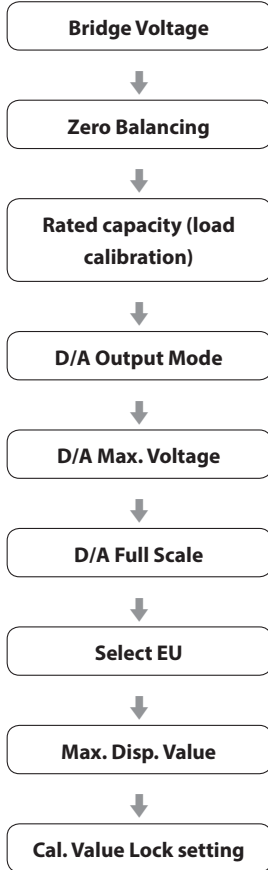

- See “9-2. D/A Converter” on page 73 for information about D/A settings.

#### 5-3-1. Bridge Voltage

Options: 2.5V, 10V

Select the bridge voltage to supply to the strain gauge transducer.

Press the ENT button to change the bridge voltage.

- As a reference for setting the bridge voltage, consider that the output from the sensor will increase, and set the maximum voltage in a range that does not exceed the maximum excitation voltage on the sensor test result sheet.

#### ATTENTION

If you set a value that exceeds the sensor's maximum excitation voltage, the sensor could be damaged.

#### NOTE

- The default value is 2.5 V.
- In TEDS calibration, when TEDS data is read, if the bridge voltage setting is greater than the maximum excitation voltage recorded in the TEDS memory, the bridge voltage will be changed to a value less than the maximum excitation voltage.

#### 5-3-2. Zero Balancing

With no load on the sensor, select Execute.

During zero balancing, a pop-up appears to show that it is in progress. When zero balancing completes, the setting screen for the next procedure appears.

To skip zero balancing, select Skip.

- If a calibration error appears, conduct countermeasures according to the error message.

#### 5-3-3. Rated capacity (load calibration)

- 1 Set the rated capacity and press the ENT button.

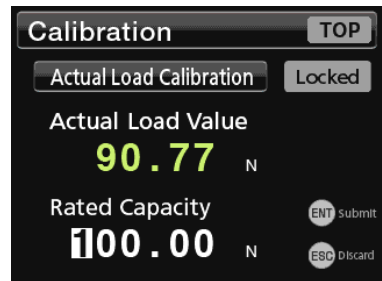



- 2** With an actual load applied to the sensor, press the ENT button.



- 3** Check the load calibration results. If there are no problems, press the ENT button to confirm them.

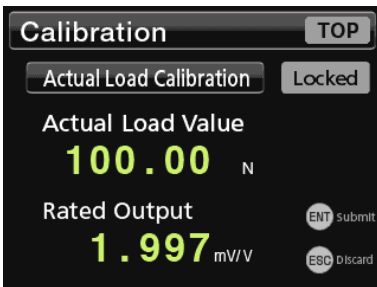

If there is a problem, press the ESC button and restart from step 2.

- If a calibration error appears, conduct countermeasures according to the error message.

**ATTENTION**

The Rated Capacity is set to the D/A Full Scale value.

**NOTE**

- The decimal point position set here will be used as the indicator value decimal point position.
- For information about D/A settings, see "9-2. D/A Converter" on page 73.

**5-3-4. D/A Output Mode**

Options: Voltage, Current

**5-3-5. D/A Max. Voltage**

Range:  $\pm 1$ — $\pm 10$  (1V increments)

**5-3-6. D/A Full Scale**

With the "9-2-1. D/A Zero" value as the reference, set the span for the indicator values output to D/A. When the "9-2-1. D/A Zero" setting value is added, the "9-2-4. D/A Max. Voltage" setting value voltage (20 mA when in electrical current mode) is output.

**NOTE**

For information about D/A settings, see "9-2. D/A Converter" on page 73.

**5-3-7. Select EU**

Select the unit that corresponds to the indicator value.

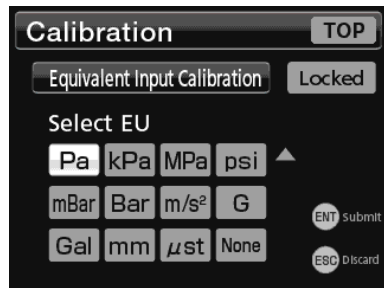
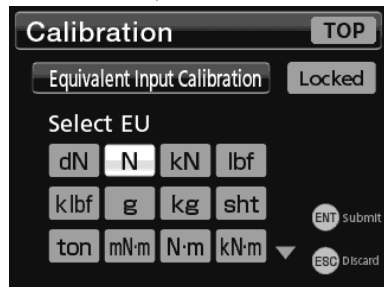

Options: dN,N, kN, lbf, klbf, g, kg, sht, ton, mN·m, N·m, kN·m, Pa, kPa, MPa, psi, mBar, Bar, m/s<sup>2</sup>, G, Gal, mm, μst, none

**5-3-8. Max. Disp. Value**

Set the maximum displayed indicator value (page 43).

**5-3-9. Cal. Value Lock**

To prevent unintended changes to the calibration value, Cal. Value Lock should usually be set to ON.

## 5. Calibration

### 5-4. TEDS calibration

A TEDS sensor has calibration information, including rated output and rated capacity, stored in its memory.

TEDS calibration reads this calibration information to automatically record calibration values.

- Press and hold the TEDS button to open the TEDS calibration screen without needing to select the Function Menu.

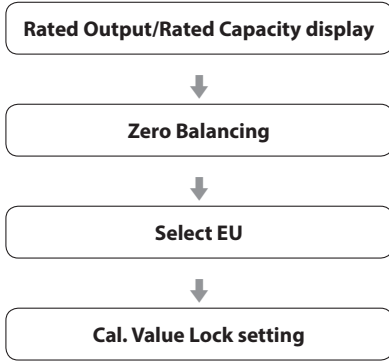

#### 5-4-1. Rated Output/Rated Capacity display

After reading the TEDS data, the Rated Output/Rated Capacity is shown.

##### Rated capacity digit shown during TEDS calibration

TEDS sensor Rated Capacity	unit	Indicator value
1	N, kN	01.000
2	N, kN	02.000
3	N, kN	03.000
4	N, kN	04.000
5	N, kN	05.000
10	N, kN	010.00
20	N, kN	020.00
30	N, kN	030.00
40	N, kN	040.00
50	N, kN	050.00
100	N, kN	0100.0
200	N, kN	0200.0
300	N, kN	0300.0
400	N, kN	0400.0
500	N, kN	0500.0

#### NOTE

- TEDS data is automatically read when the power supply is turned ON.
- The rated capacity decimal point position set here will be used as the indicator value decimal point position.
- D/A settings will become as follows.
  - D/A Output Mode: voltage
  - D/A Max. Voltage: 10 V
- The Max. Disp. Value is set as 110% of the Rated Capacity.

#### ATTENTION

The bridge voltage setting will be set to a value that is less than the Maximum Excitation Voltage stored in the TEDS memory.

#### 5-4-2. Zero Balancing

With no load on the sensor, select Execute.

During zero balancing, a pop-up appears to show that it is in progress. When zero balancing completes, the setting screen for the next procedure appears.

To skip zero balancing, select Skip.

- If a calibration error appears, conduct countermeasures according to the error message.

#### 5-4-3. Select EU

Options: dN, N, kN, lbf, klbf, g, kg, sht, ton, mN-m, N-m, kN-m, Pa, kPa, MPa, psi, mBar, Bar, m/s<sup>2</sup>, G, Gal, mm, μst, none

Select the unit that corresponds to the indicator value.

- If a sensor with TEDS built in is connected, the read unit will be set.

#### 5-4-4. Cal. Value Lock

To prevent unintended changes to the calibration value, Cal. Value Lock should usually be set to ON.

#### ATTENTION

If Cal. Value Lock is ON, automatic calibration will not occur when the unit is turned on.

### 5-5. Remote Sense/TEDS

Terminals 1 and 2 in the signal input and output terminal bank are data terminals for use by both remote sense and TEDS sensors.

Before connecting the sensor, set which type will be connected in advance.

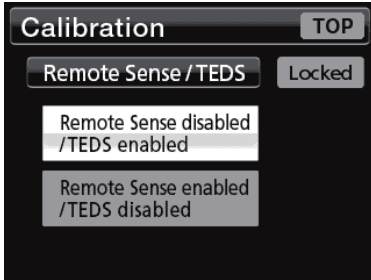

Options: Remote Sense enabled/TEDS disabled  
Remote Sense disabled/TEDS enabled

#### ATTENTION

Incorrect connections or settings could cause damage to sensors.

### 5-6. Select Min. Grid

Set the minimum digital change of the indicator value.



Options: 1, 2, 5, 10

### 5-7. Select Disp. Times

Select the number of times that the indicator value is shown per second.



Options: 4, 6, 10, 20

### 5-8. Max. Disp. Value

Set the maximum displayed indicator value.

The default value is set at 110% of the Rated Capacity.

If this value is exceeded, "±FULL: Plus Value Over (Over Max. Disp. Value)" appears in a pop-up message.



#### ATTENTION

The input value will be checked with a value converted to match the input signal. If the value converted to match the input exceeds 3.2 mmV/V, the setting value will be adjusted to be equivalent to 3.2 mmV/V. The default value will be checked in the same manner and adjusted if necessary.

## 5. Calibration

### 5-9. Select EU

Select the indicator value unit.  
Select the unit that corresponds to the indicator value.

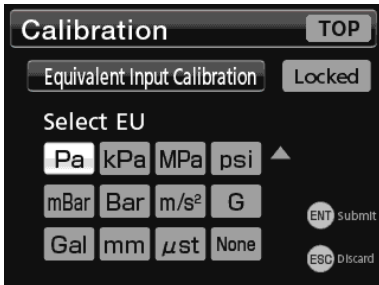
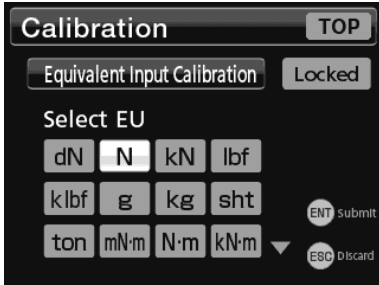

Options: dN,N, kN, lbf, k lbf, g, kg, sht, ton, mN·m, N·m, kN·m, Pa, kPa, MPa, psi, mBar, Bar, m/s<sup>2</sup>, G, Gal, mm, μst, none

#### NOTE

The display unit is shown next to the indicator value, but it has no effect on internal calculations.  
For example, the calibration value will not change even if the display unit is changed from "N" to "kN".

### 5-10. Sensor input logic

The sensor input logic can be reversed artificially.  
Normally, "Standard" should be used.

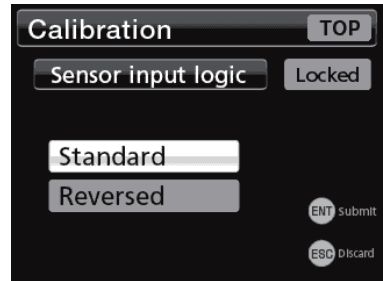

#### NOTE

- "Reversed" does not electrically reverse the input.
- After changing this setting, always redo zero.

### 5-11. Zero Balancing

You can conduct Zero Balancing calibration even without resetting the calibration value.

#### 1 Set Cal. Value Lock to OFF.

See "5-1-1. Locking and unlocking calibration values" on page 37.

#### 2 With no load on the sensor, press and hold the ZERO button.

During zero balancing, a pop-up appears to show that it is in progress.

If a calibration error appears, conduct countermeasures according to the error message.

#### 3 Set Cal. Value Lock to ON.

### 5-12. Digital Zero

The current indicator value becomes zero.

When Cal. Value Lock is set to ON, press and hold the ZERO button or set D/Z to ON for the control input terminals.



- The range for Digital Zero is the range set by Digital Zero Limit.
- Digital Zero is cleared by turning off the power supply or using Clear Digital Zero.

#### ATTENTION

- This only functions when Cal. Value Lock is ON and Enable Digital Zero is ON.
- When Cal. Value Lock is OFF, this function is replaced by Zero Balancing.

# 6. Condition Setting

## 6-1. Filter

### 6-1-1. Select LPF

Set the low pass filter cutoff frequency (Hz).

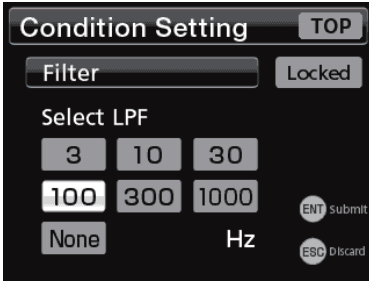

Options: 3, 10, 30, 100, 300, 1000, None

#### NOTE

When set to "None", the AD converter anti-aliasing function is enabled for sampling frequencies to the top of the range.

### 6-1-2. Select Num. of Moving Avg.

Set the moving average number for the measured data.

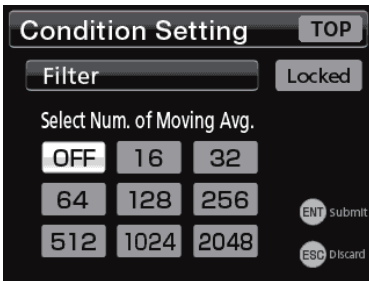

Options: OFF, 16, 32, 64, 128, 256, 512, 1024, 2048

### 6-1-3. Auto Digital Filter

When the input signal is stable, the unit can temporarily set the filter's moving average number to 1024, reducing indicator value unsteadiness.

This function is used for the display of indicator values and bar meters and affects judgments and DA output.

It does not function during graph display or hold execution, so it has no effect on measured values.

This function can be disabled by setting it to OFF.

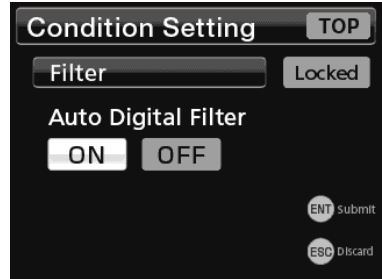

Options: ON, OFF

## 6-2. Motion Detect

Set the parameters used to detect stability.

The indicator value is judged to be stable if a difference less than the set width occurs between the current indicator value and the indicator value 100 ms before, and this continues for the set time.

The Motion Detect function is closely related to the comparison mode. For details, see "7-3. Comp. Mode Setting".

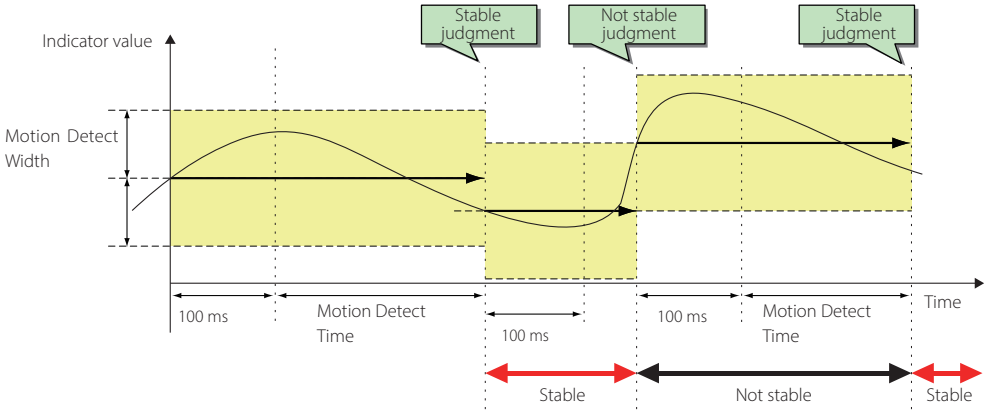

### 6-2-1. Time



### 6-2-2. Width



## 6. Condition Setting

### 6-3. Zero Tracking

This function automatically tracks drift and other gradual changes to the zero point.

With Zero Tracking, when the zero point moves no more than the set width, the indicator value is automatically adjusted to zero each set time interval.

This only functions when Cal. Value Lock is ON and Enable Digital Zero is ON.

Zero Tracking will not function if its Time is set to 0.0 seconds and its Width is set to 0.0.

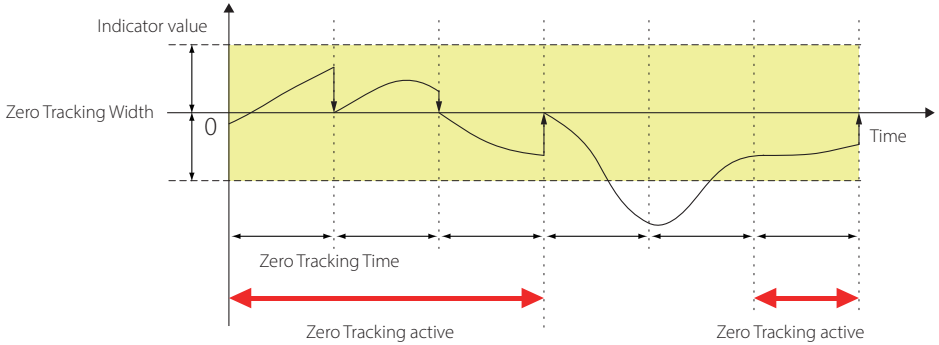

#### 6-3-1. Time

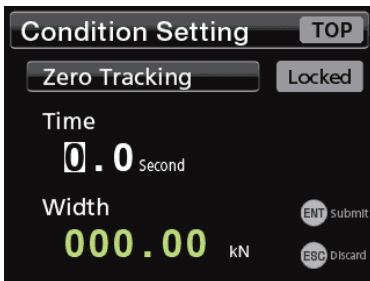

#### 6-3-2. Width

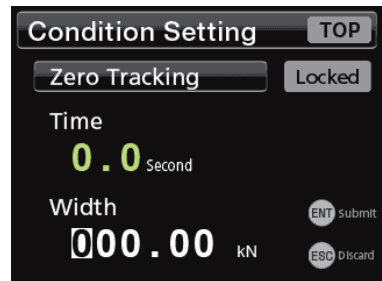



### 6-4. Digital Zero Offset

The set value is subtracted from the measured value (digital zero).

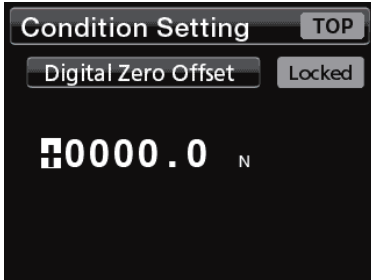

### 6-5. Digital Zero

#### 6-5-1. Enable Digital Zero

When Enable Digital Zero is set to OFF, the Digital Zero function will not be executed when you press and hold the ZERO button or set D/Z to ON for the control input terminals.

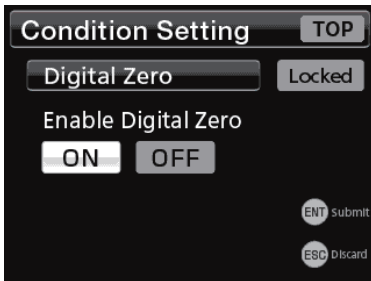

#### 6-5-2. Digital Zero Limit Value

Set the range for Digital Zero capture. (The setting value unit is the same as for the indicator value.)

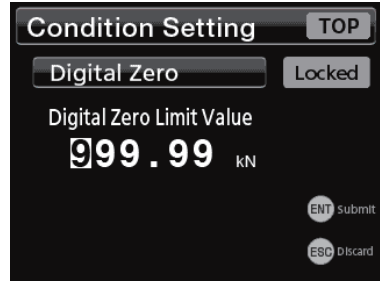

#### ATTENTION

If the current sensor input value exceeds the Digital Zero Limit setting value, "Digital Zero Limit error" appears and the indicator value does not become zero.

Even when Enable Digital Zero is set to ON, if Cal. Value Lock is set to OFF, the zero function will not be executed even when the ZERO button is pressed and held or D/Z is set to ON for the control input terminal.

#### NOTE

If you execute the Clear Digital Zero function, the current sensor input value is shown with the Zero Balancing value as zero.

#### 6-5-3. Clear Digital Zero

The display adjustment that has been made with Digital Zero is reverted so that the unadjusted value is shown again.

When Zero Balancing has been conducted, the value is shown as zero.

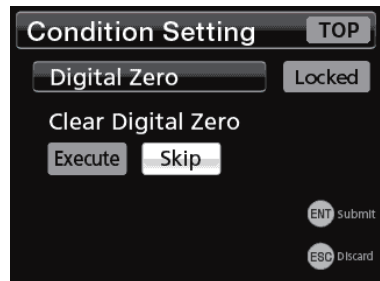

## 6. Condition Setting

### 6-6. Control Input Check

Depending on the input signal, LOW (ON) or HIGH (OFF) is shown.

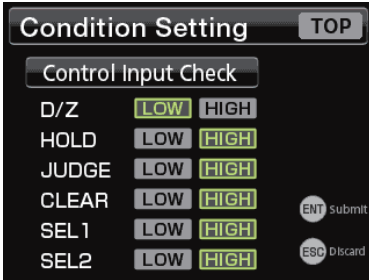

### 6-7. Judge Output Check

You can turn one judgment output option ON. Use when conducting a judgment output wiring check. Be aware that it will not operate as an indicator at this time.

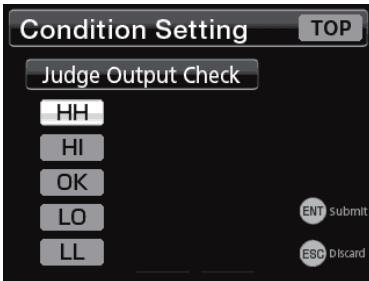

Select HH, HI, OK, LO or LL to turn judgment output ON for that item.

### 6-8. Static Strain Disp. Mode

Set whether to show the input signal with the strain amount unit ( $\mu\text{ST}$ ).

Use when checking sensor output and unsteadiness in indicator values, including for sensors and cables, and when making adjustments for discrepancies.

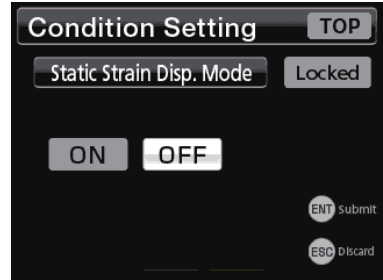

#### NOTE

- Press the ESC button to exit static strain mode.
- Static strain is shown using 1-gauge method with a gauge factor of 2.0.
- When using a sensor with a common gauge factor of 2.0, there is a relationship of  $1 \text{ mV/V} = 2000 \mu\text{st}$ .

### 6-9. Select Data Output

Select the data output from the D/A Converter.

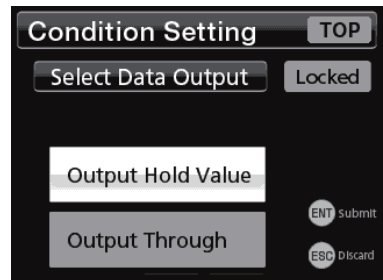

Select Data Output has the following two options. The hold value is output in coordination with the display. The input is output as is.

## 7. Comparison Setting

### 7-1. Comp. Value Setting

Use this function to set the high limit, low limit, high high limit and low low limit values can compare them with indicator values, and turn judgment output ON for each one.

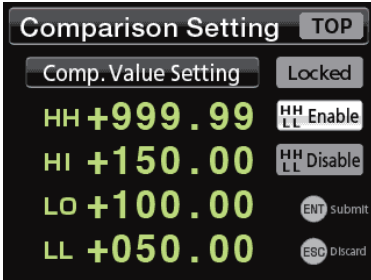

- When HH LL Limit Enable is set to Disable, the HH and LL values cannot be changed.

HH: high high limit value

HI: high limit value

LO: low limit value

LL: low low limit value

#### ATTENTION

Low low limit value < low limit value < high limit value < high high limit value

If the above condition is not met, "Error message" will appear and the setting value will not be confirmed. Input values that meet the above condition, and press the ENT button.

#### NOTE

You can enable or disable the HH and LL limits.

Use the ▲ and ▼ buttons to change the selection, and select either HH LL Enable or HH LL Disable at the right edge of the screen, and press the ENT button to confirm the setting.

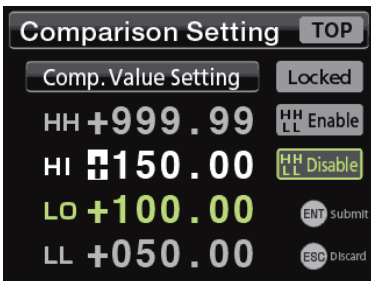

### 7-2. Comp. Pattern Setting

You can change the judgment output high limit and low limit assignments of HH, HI, LO and LL.

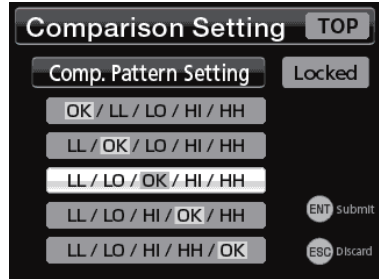

Options:

OK/LL/LO/Hi/HH

LL/OK/LO/Hi/HH

LL/LO/OK/Hi/HH

LL/LO/Hi/OK/HH

LL/LO/Hi/HH/OK

When set to LL/LO/OK/Hi/HH, two are assigned to high limit and two are assigned to low limit (when Standard Comp. Output Pattern setting)

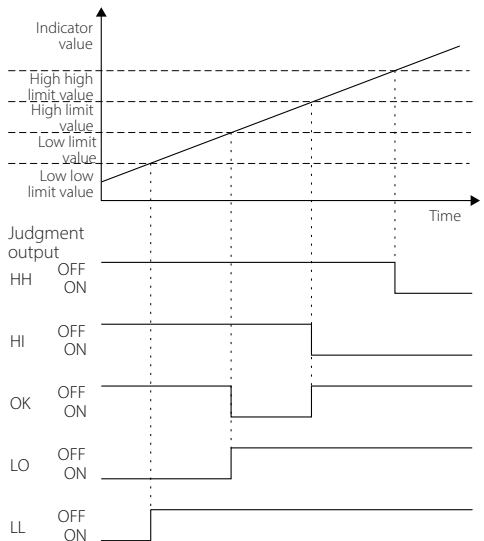

## 7. Comparison Setting

When set to OK/LL/LO/Hi/HH, all are assigned to high limit (when Standard Comp. Output Pattern setting)

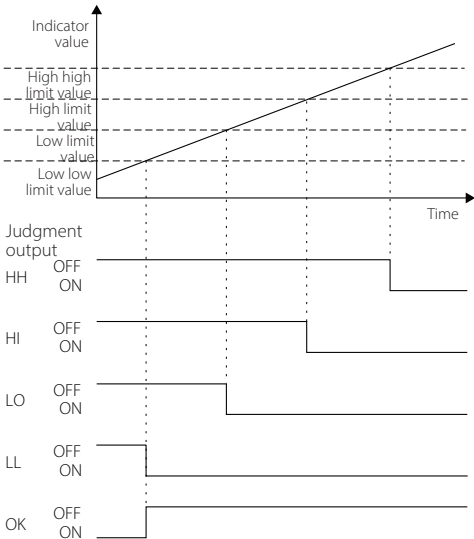

When set to LL/OK/LO/Hi/HH, three are assigned to high limit and one is assigned to low limit (when Standard Comp. Output Pattern setting)

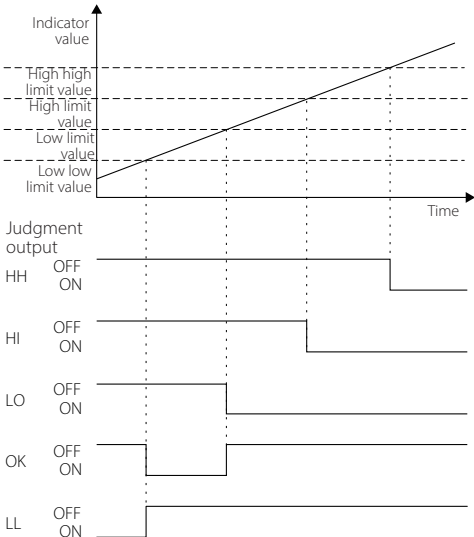

When set to LL/LO/Hi/OK/HH, one is assigned to high limit and three are assigned to low limit (when Standard Comp. Output Pattern setting)

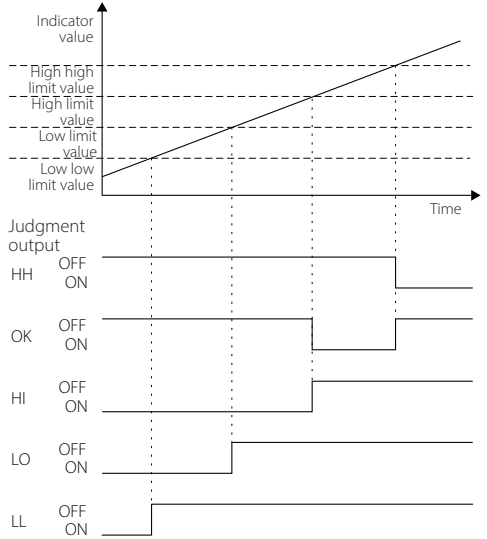

When set to LL/LO/Hi/HH/OK, all are assigned to low limit (when Standard Comp. Output Pattern setting)

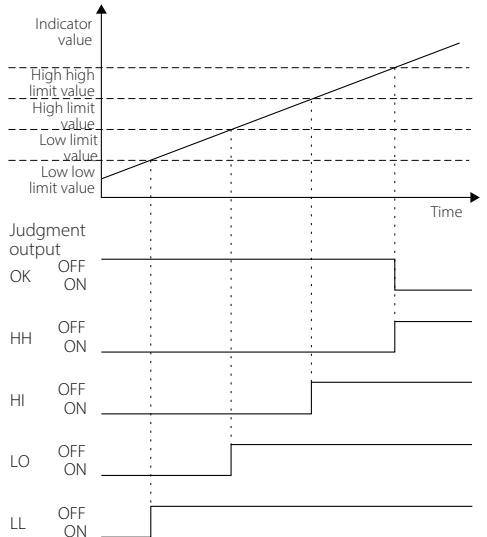

### 7-3. Comp. Mode Setting

Set the conditions for judging high limit, low limit, high high limit and low low limit.



#### NOTE

Compare During Stable, Compare Except Nearly Zero and Compare During Stable Except Nearly Zero comparison modes are closely related to Motion Detect and Nearly Zero functions. See "6-2. Motion Detect" and "7-8. Nearly Zero" for details.

### 7-4. HH LL Limit Enable

Set whether to enable or disable high high limit and low low limit judgment output.

When set to Disable, high high limit and low low limit judgments will stop being output.

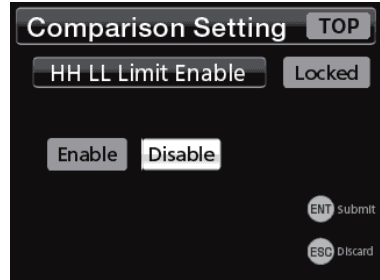

## 7. Comparison Setting

### 7-5. Hysteresis

This function applies a width to switching from ON to OFF for high high limit, high limit, low limit and low low limit judgment output. If the indicator value fluctuates near a value, causing judgment output to chatter between ON and OFF, adjustment of the hysteresis value can prevent this chattering.

The operation of hysteresis changes as follows according to the Comp. Pattern Setting.

For limit boundary values that are greater than the OK position, it operates in the negative direction. For limit boundary values that are less than the OK position, it operates in the positive direction.

When the Comp. Pattern Setting is LL/LO/OK/HH/HH, hysteresis activates for the high high limit and high limit values when an indicator value decreases and for the low low limit and low limit values when an indicator value increases.

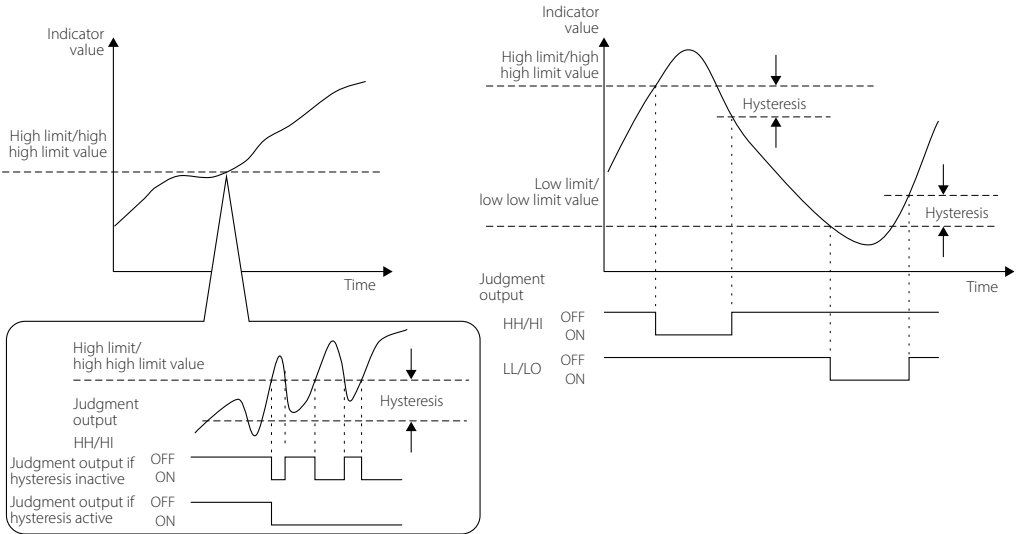

Judgment output conditions (when Comp. Output Pattern is set to Standard Output)

Judgment output	Status	Condition
HH	OFF → ON	High high limit value < indicator value
	ON → OFF	Indicator value ≤ (high high limit value – hysteresis setting value)
HI	OFF → ON	High limit value < indicator value
	ON → OFF	Indicator value ≤ (high limit value – hysteresis setting value)
LO	OFF → ON	Indicator value < low limit value
	ON → OFF	(Low limit value + hysteresis setting value) ≤ indicator value
LL	OFF → ON	Indicator value < low low limit value
	ON → OFF	(Low low limit value + hysteresis setting value) ≤ indicator value

#### ATTENTION

Set the hysteresis setting value so that it meets the following conditions.

High limit value < (high high limit value – hysteresis setting value)

Low limit value < (high limit value – hysteresis setting value)

Low low limit value < (low limit value – hysteresis setting value)

#### NOTE

- The same Hysteresis Width setting is used with high limit, low limit, high high limit and low low limit values.

- If set to "0", hysteresis will be disabled.



### 7-6. Judge Signal

Enable/disable judgment output control signals.

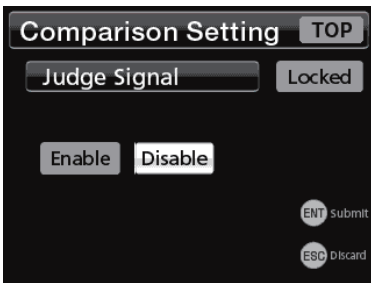

Disable: judgment output always active  
 Enable: judgment output only when Judge Signal is ON

### 7-7. Comp. Output Pattern

The two types of judgment output operation are Standard Output and Area Output.

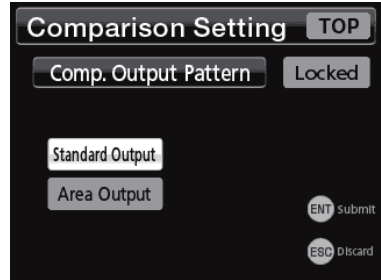

#### 7-7-1. Standard Output

Judgment output operation is as follows.

(when Hysteresis is "0")

HH: high high limit value < indicator value

HI: high limit value < indicator value

LO: indicator value < low limit value

LL: indicator value < low low limit value

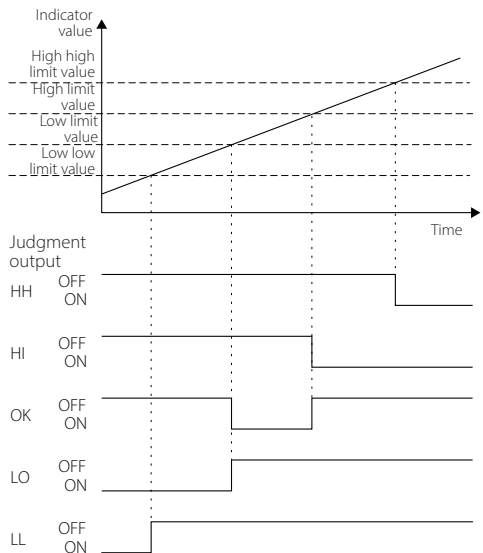

#### NOTE

Judgment output operation changes according to the Hysteresis setting. See "7-5. Hysteresis" on page 54.

## 7. Comparison Setting

### 7-7-2. Area Output

Judgment output operation is as follows.

(when Hysteresis is "0")

HH: high high limit value < indicator value

HI: high limit value < indicator value < high high limit value

LO: low low limit value < indicator value < low limit value

LL: indicator value < low low limit value

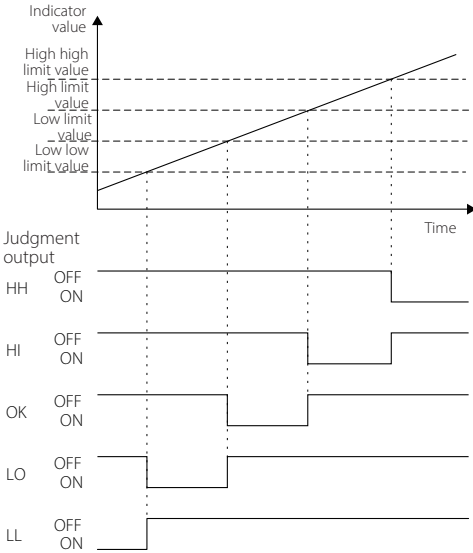

#### NOTE

Judgment output operation changes according to the Hysteresis setting. See "7-5. Hysteresis" on page 54.

### 7-8. Nearly Zero

Set the range in which indicator values are evaluated as being nearly zero.



#### NOTE

The Nearly Zero judgment result is closely related to high limit, low limit, high high limit and low low limit judgment output. See "7-3. Comp. Mode Setting" on page 53 for details.

### 7-9. Bar meter zero position

Set the zero position of the bar meter on the Home Screen. When "Automatic" is selected, the left edge, the center or the right edge can be selected according to the comparison value set by the "Comp. Value Setting". When "Left-edge fixed" is selected, the left edge will always be zero regardless of the "Comp. Value Setting".

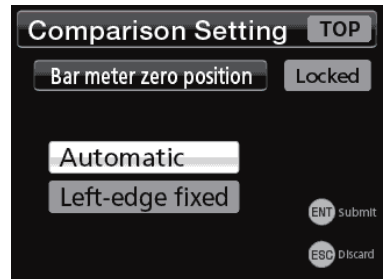



## 8. Hold Function Setting

### 8-1. Hold Mode

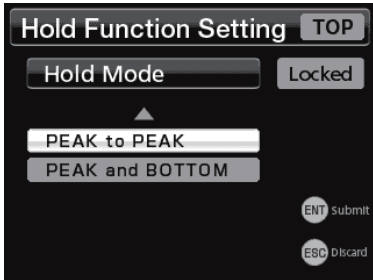
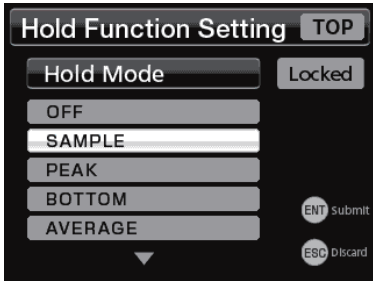

Hold Mode has seven settings.

#### **OFF**

No hold

#### **SAMPLE**

Sample and hold

#### **PEAK**

Peak hold

#### **BOTTOM**

Bottom hold

#### **AVERAGE**

Average hold

#### **PEAK to PEAK**

Peak to peak hold

#### **PEAK and BOTTOM**

Peak and bottom hold

## 8. Hold Function Setting

### 8-1-1. Sample and hold

The HOLD button or a HOLD signal from a control input terminal can be used to hold the indicator value. Press the HOLD button once to hold the indicator value, and press it again to stop holding the value.

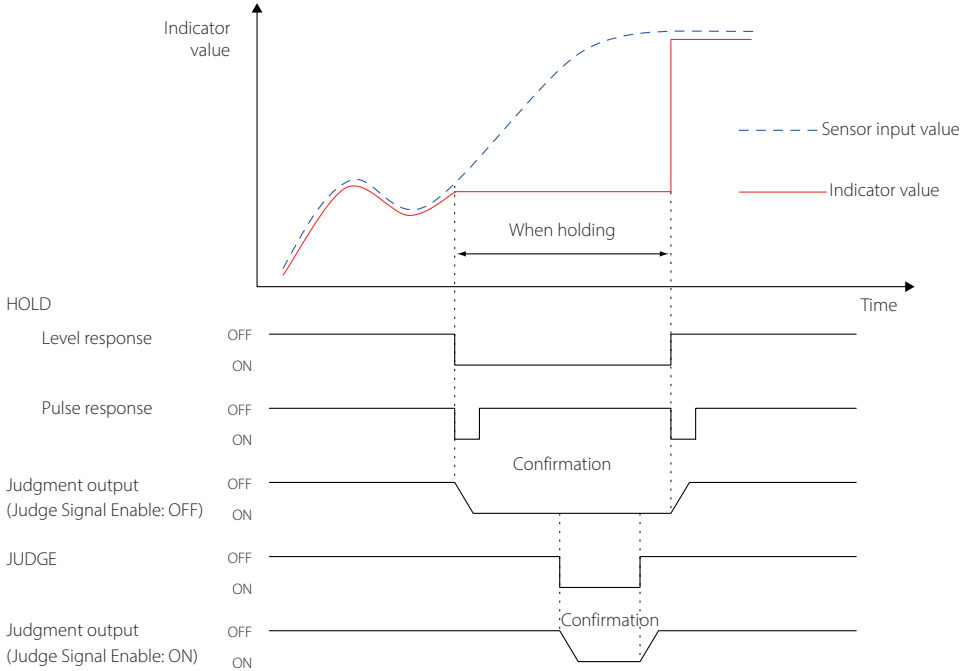

- Set the External Hold Mode to make the unit respond to level or pulse as a control input terminal HOLD signal.
- Judgment output conduct depends on the comparison mode. The above illustration shows operation when set to Compare During Held.
- Judgment output operation depends on the Judge Signal Enable setting.
  - When set to Enable and the JUDGE signal is ON for the control input terminals, judgment output will occur in response to input signals.
  - When set to Disable, judge is always active, and judgment output always occurs in response to an input signal.
- Zone Definition cannot be used with the sample and hold mode.
- When using the sample and hold mode, you cannot use the ESC button or a control input terminal CLEAR signal.

### 8-1-2. Peak hold

#### 8-1-2-1. No zone definition

After pressing the HOLD button or while a control input terminal HOLD signal is ON, the maximum value (peak value) in the indicator value positive direction is held. When the HOLD button is pressed again or when the control input terminal HOLD signal is turned OFF, peak hold ends.

When holding, the peak value is also reset by pressing the CLEAR (ESC) button or by a control input terminal CLEAR signal becoming ON.

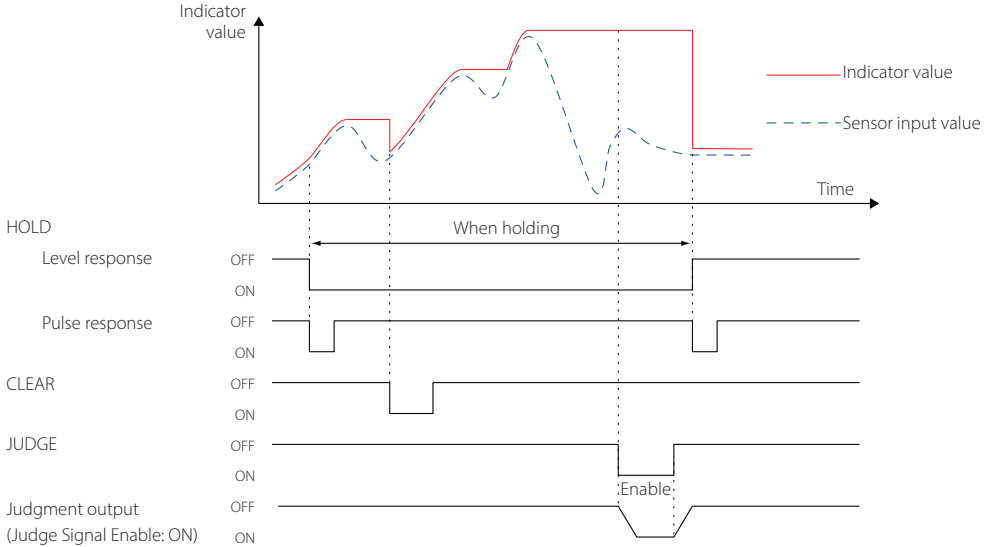

## 8. Hold Function Setting

### 8-1-2-2. Zone definition used

The indicator value when the hold operation completes continues to be shown.

The display is reset by pressing the CLEAR (ESC) button or by a control input terminal CLEAR signal becoming ON.

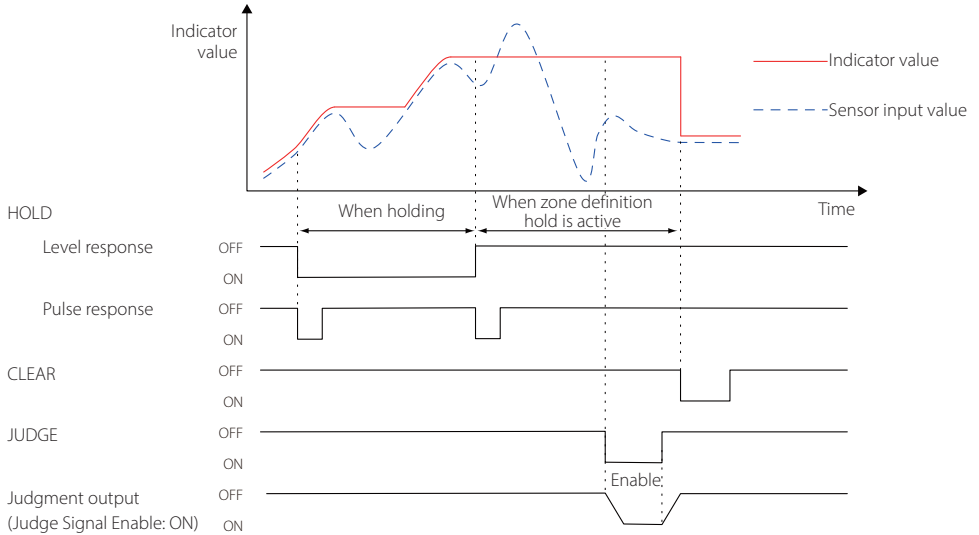

When holding, the peak value is reset by pressing the CLEAR (ESC) button or by a control input terminal CLEAR signal becoming ON.

### 8-1-3. Bottom hold

#### 8-1-3-1. No zone definition

After pressing the HOLD button or while a control input terminal HOLD signal is ON, the lowest indicator value (bottom value) is held. When the HOLD button is pressed again or when the control input terminal HOLD signal is turned OFF, bottom hold ends. When holding, the bottom value is also reset by pressing the CLEAR (ESC) button or by a control input terminal CLEAR signal becoming ON.

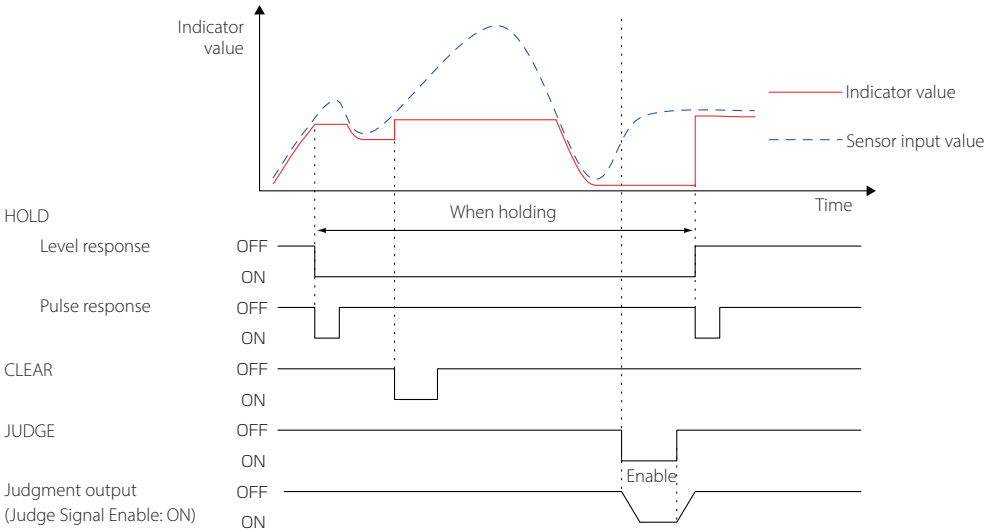

## 8. Hold Function Setting

### 8-1-3-2. Zone definition used

The indicator value when the hold operation completes continues to be shown.

The display is reset by pressing the CLEAR (ESC) button or by a control input terminal CLEAR signal becoming ON.

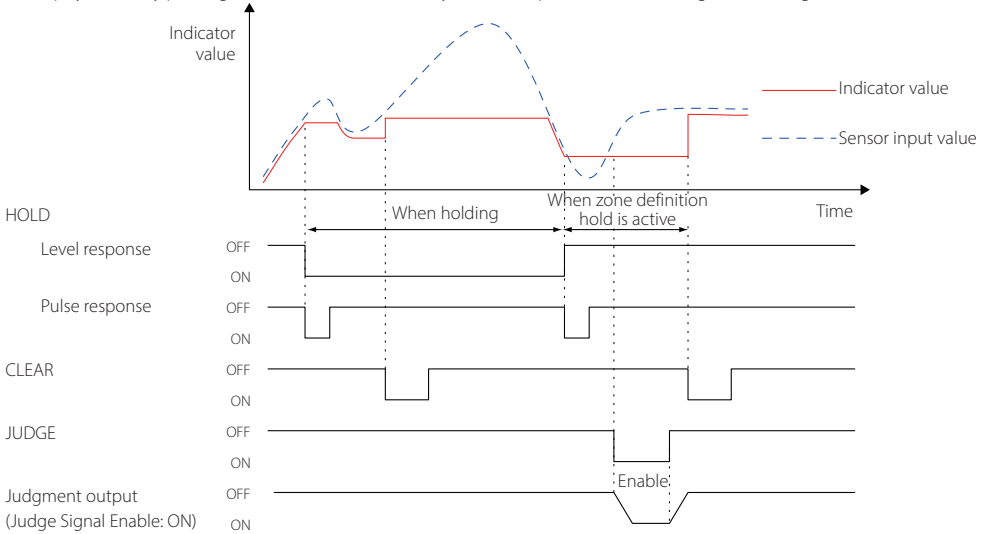

When holding, the bottom value is reset by pressing the CLEAR (ESC) button or by a control input terminal CLEAR signal becoming ON.

### 8-1-4. Average hold

#### 8-1-4-1. No zone definition

After pressing the HOLD button or while a control input terminal HOLD signal is ON, the average indicator value is held. When the HOLD button is pressed again or when the control input terminal HOLD signal is turned OFF, average hold ends. When holding, the average hold is also reset by pressing the CLEAR (ESC) button or by a control input terminal CLEAR signal becoming ON.

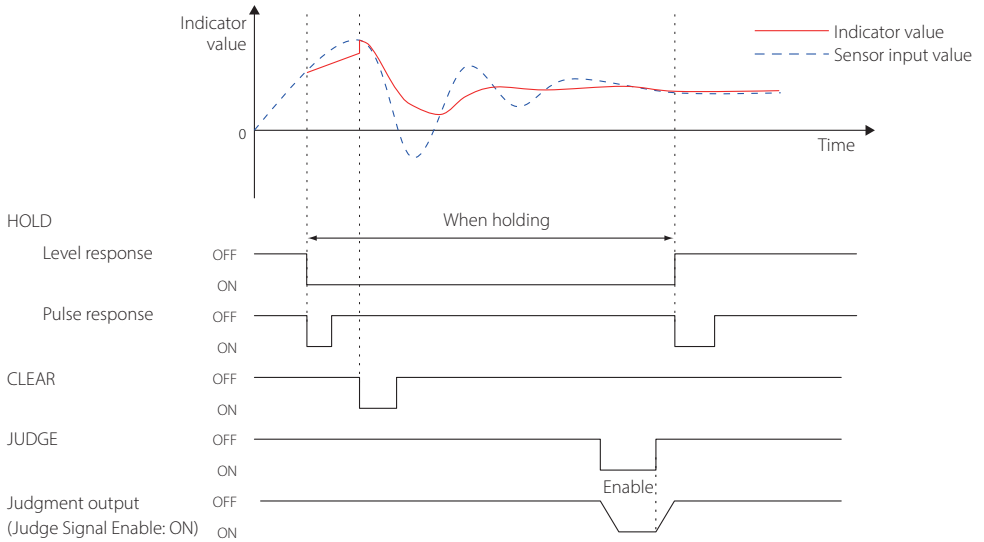

Even during the HOLD interval, if the maximum average calculation time is exceeded, average hold will end. If Zone Definition is set to ON, the average value is held at that point (page 71).

## 8. Hold Function Setting

### 8-1-4-2. Zone definition used

The indicator value when the hold operation completes continues to be shown.

The display is reset by pressing the CLEAR (ESC) button or by a control input terminal CLEAR signal becoming ON.

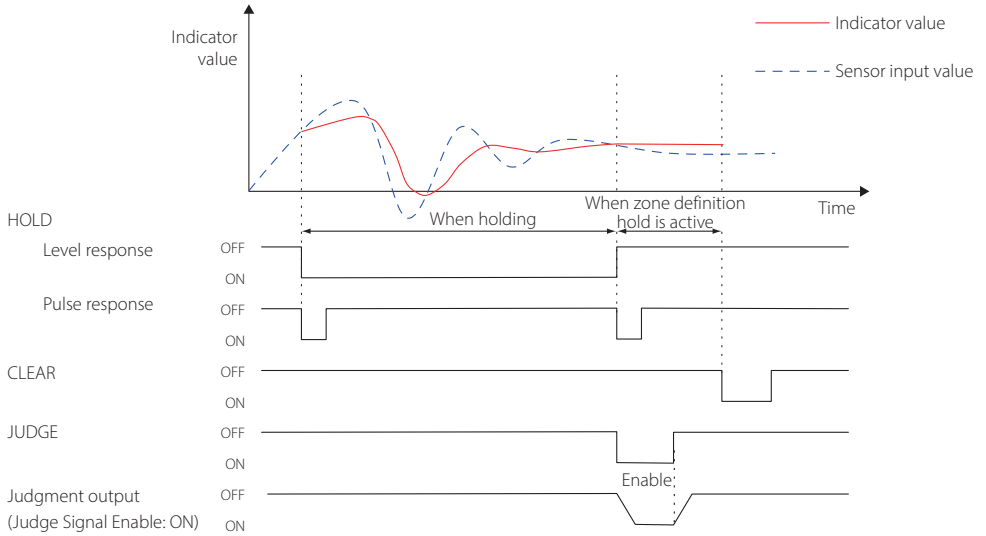



### 8-1-5. Peak to peak hold

#### 8-1-5-1. No zone definition

After pressing the HOLD button or while a control input terminal HOLD signal is ON, the maximum (peak) and minimum (bottom) values are held each time sampled and the maximum difference between the peak and bottom values is displayed as the indicator value. When the HOLD button is pressed again or when the control input terminal HOLD signal is turned OFF, the peak to peak hold ends.

When holding, the peak to peak hold value is also reset by pressing the CLEAR (ESC) button or by a control input terminal CLEAR signal becoming ON.

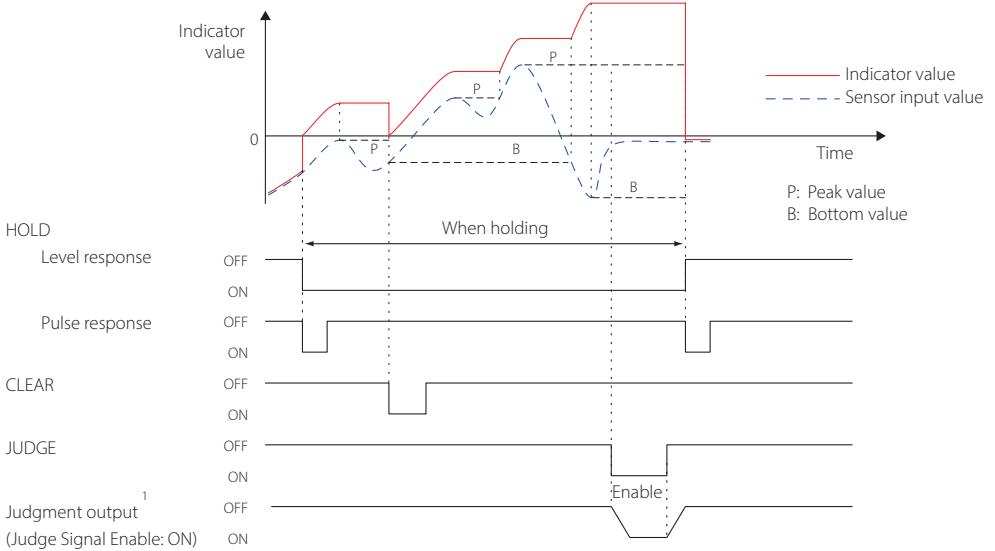

<sup>1</sup> Judgment output is determined by the maximum difference between the peak and bottom values.

## 8. Hold Function Setting

### 8-1-5-2. Zone definition used

The indicator value when the hold operation completes continues to be shown.

The display is reset by pressing the CLEAR (ESC) button or by a control input terminal CLEAR signal becoming ON.

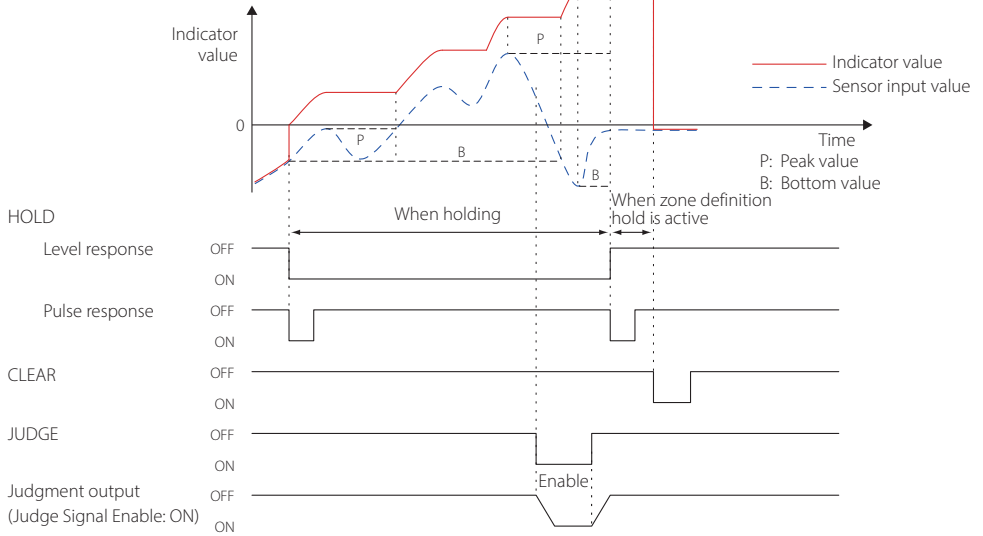

When holding, the peak to peak hold value is reset by pressing the CLEAR (ESC) button or by a control input terminal CLEAR signal becoming ON.

### 8-1-6. Peak and bottom hold

#### 8-1-6-1. No zone definition

After pressing the HOLD button or while a control input terminal HOLD signal is ON, the maximum (peak) and minimum (bottom) values are held each time sampled and the peak or bottom value is held and displayed.

Whether the peak and bottom values are each within the comparison value range can be judged.

When the HOLD button is pressed again or when the control input terminal HOLD signal is turned OFF, the peak and bottom hold ends.

When holding, the peak and bottom values are also reset by pressing the CLEAR (ESC) button or by a control input terminal CLEAR signal becoming ON.

- When peak and bottom hold is active, LL/LO/OK/HI/HH will appear regardless of the Comp. Pattern Setting.

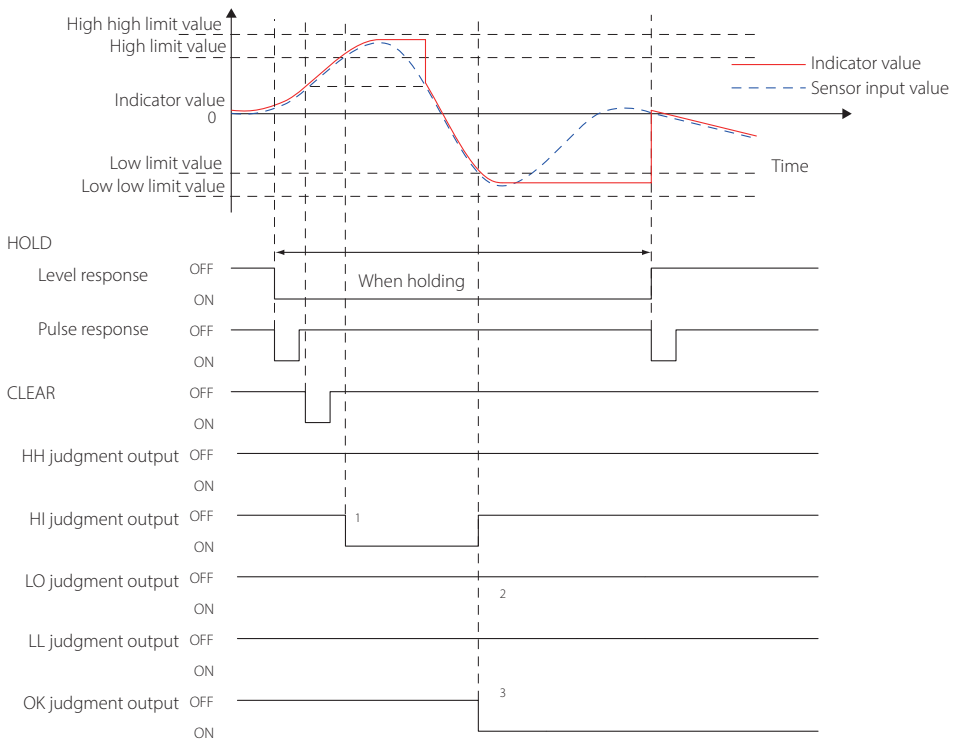

<sup>1</sup> If the peak value exceeds HI, the HI judgment output will become ON.

<sup>2</sup> If the bottom value becomes less than LO, the OK judgment output will become ON, so the LO judgment output will stay OFF.

<sup>3</sup> When the peak value becomes between HH and HI and the bottom value becomes between LO and LL, the OK judgment output will become ON.

## 8. Hold Function Setting

### 8-1-6-2. Zone definition used

The indicator value when the hold operation completes continues to be shown.

The display is reset by pressing the CLEAR (ESC) button or by a control input terminal CLEAR signal becoming ON.

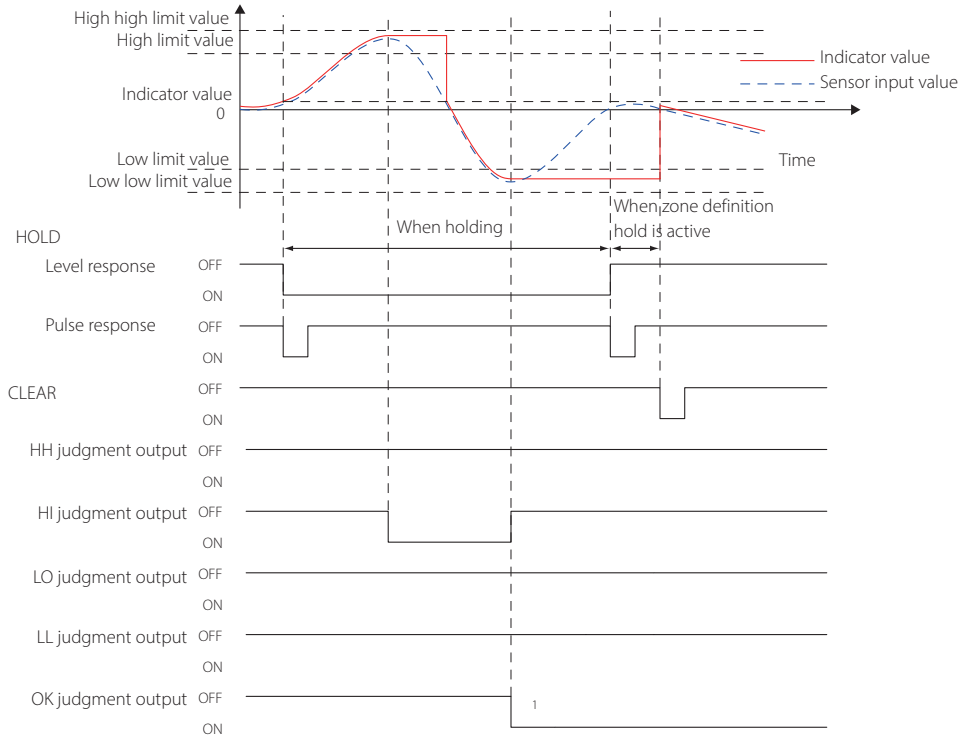

<sup>1</sup> When the peak value becomes between HH and HI and the bottom value becomes between LO and LL, the OK judgment output will become ON.

### 8-1-6-3. Example when the judgment output does not become OK

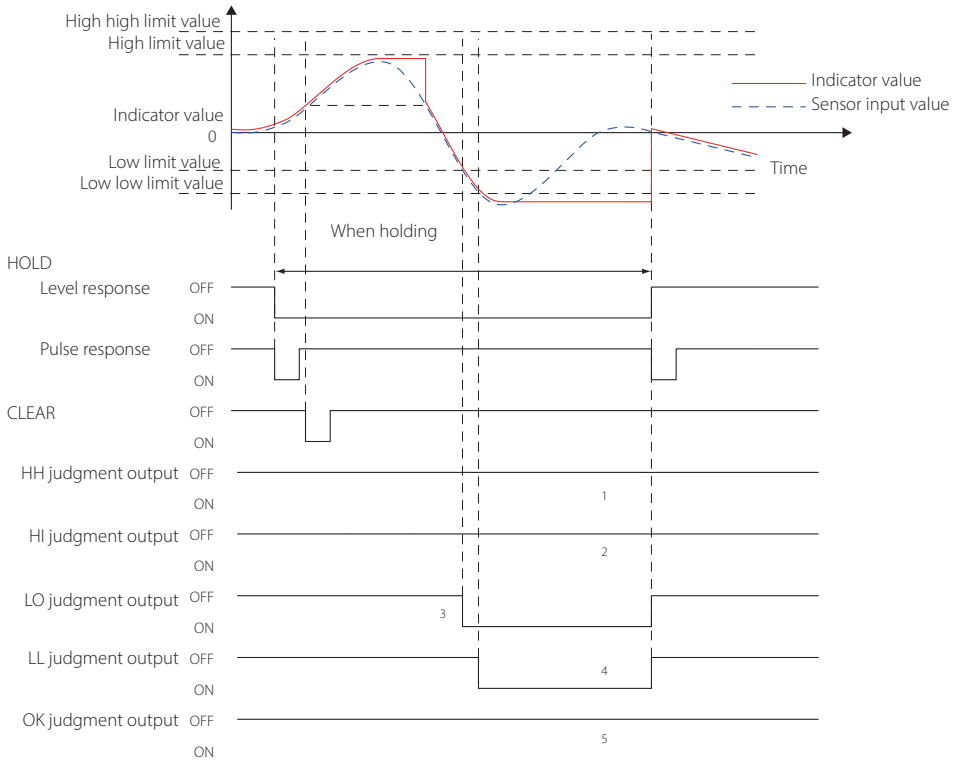

<sup>1</sup> If the peak value does not exceed HH, HH judgment output stays OFF.

<sup>2</sup> If the peak value does not exceed HI, HI judgment output stays OFF.

<sup>3</sup> If the bottom value becomes less than LO, the LO judgment output becomes ON.

<sup>4</sup> If the bottom value becomes less than LL, the LL judgment output becomes ON.

<sup>5</sup> In summary, the peak value does not exceed HI and the bottom value is less than LL, so the OK judgment output will not turn ON.

- If Zone Definition is active, judgment output will also be held, so you can search for the cause of the error.

## 8. Hold Function Setting

### 8-1-6-4. Example when HH LL Limit is disabled

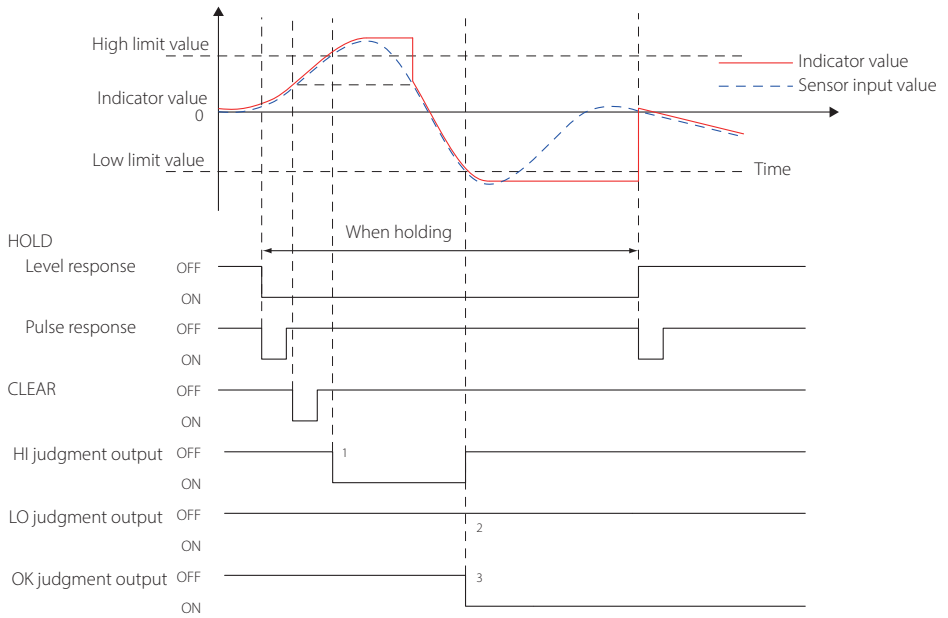

<sup>1</sup> If the peak value exceeds HI, the HI judgment output will become ON.

<sup>2</sup> If the bottom value becomes less than LO, the OK judgment output will become ON, so the LO judgment output will stay OFF.

<sup>3</sup> When the peak value exceeds HI and the bottom value becomes less than LO, the OK judgment output will become ON.

Since HH and LL are not enabled, it will be judged OK if the peak value exceeds HI and the bottom value becomes less than LO.

### 8-2. Times of Average

When using average hold, a maximum of 20000 samples can be used to calculate the average.

However, by setting Times of Average to 2 or more, you can increase the number of measurements used in each sample for the calculation.

Times of Average setting range: 1–999

Using Times of Average, first the unit averages measurements the set number of times for each sample and then averages the values of 20000 samples.

Maximum number of measurements averaged  
= Times of Average × 20000 samples



#### NOTE

This unit can make 4000 measurements/second, so 20000 measurements take 5 seconds.

When Times of Average is set to a value of 2 or higher, the number of times that the average calculation refreshes decreases.

Times average calculation refreshes/second = 4000 measurements/second ÷ Times of Average

#### NOTE

- If Times of Average is set to 50, the refresh rate will be 80 times/second.
- If Times of Average is set to 100, the average of up to 500 seconds will be calculated.
- Using the Times of Average setting, you can set the time for which the average can be calculated, but if the maximum average calculation time is exceeded, average calculation will stop automatically. If Zone Definition is set to ON, the average value is held at that point.

### 8-3. Fast Sampling Mode

When set to ON, the A/D conversion speed while holding is increased 5x from 4000 times/second to 20000 times/second, allowing measurement with even less error.

The following hold modes are supported.

- PEAK hold
- BOTTOM hold
- PEAK to PEAK hold
- PEAK and BOTTOM hold

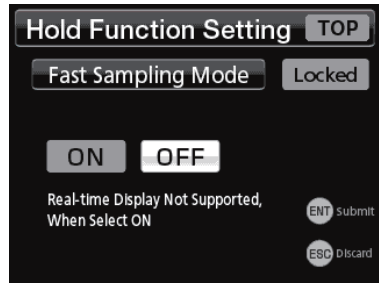

While a hold is being executed, the following screen appears and the hold value cannot be checked in real time.



After holding stops, Zone Definition mode is activated automatically and the value will be held, so you can check the hold value.

#### ATTENTION

- When high-speed sampling (fast sampling mode) is on, measurement will start 10 ms after holding starts.
- D/A sampling is 4000 times per second even during high-speed sampling (fast sampling).

## 8. Hold Function Setting

### 8-4. External Hold Mode

Select the control input terminal HOLD signal format.

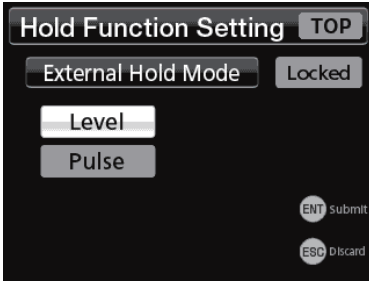

The External Hold Mode has the following two types.

- Level
- Pulse

### 8-5. CLEAR Signal

Enable or disable control input terminal CLEAR signals and the CLEAR (ESC) button.

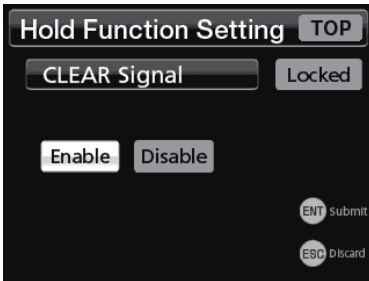

### 8-6. Zone Definition

When set to ON, the indicator value will continue to be shown after the hold ends.

Pressing the CLEAR (ESC) button or a CLEAR Signal will clear the held value.



Options: ON, OFF

### 8-7. Auto Zero

Set whether or not to automatically execute a Digital Zero when a hold starts (ON/OFF).

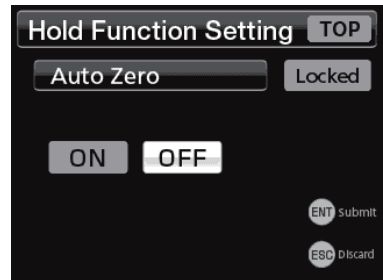

ON: automatically execute the Digital Zero function when a hold starts

OFF: do not automatically execute the Digital Zero function when a hold starts



# 9. System Settings

## 9-1. Setting Memory

You can set whether the memory is determined by an external signal or by manual input using this menu as well as select the memory used when set by menu.

You can save up to 4 memories with setting values and switch among them.

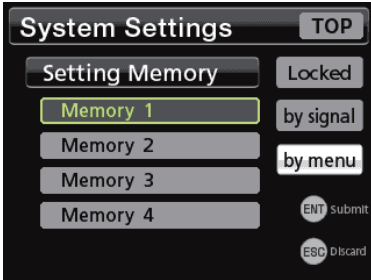

The setting currently in use is selected.

If “by menu” has been selected and confirmed, move the selection and press the ENT button to change the setting.

- There are no setting value saving or loading menu operations.
- The selected memory setting is changed directly.
- You cannot copy between setting memories.

When shipped from the factory, memory 1 to 4 are set at default values.

See the setting value list for the setting values that can be saved in memories 1 to 4.

When “by signal” is active, you can also select memories 1–4 using the SEL1 and SEL2 control input terminals. When this setting is active, you cannot select the memory from the Setting Memory screen.

To change the memory using the Setting Memory screen, select “by menu”.

When “by signal” selected		SEL2	
		OFF	ON
SEL1	OFF	Memory 1	Memory 3
	ON	Memory 2	Memory 4

### NOTE

The calibration value does not change.

### ATTENTION

- When “by signal” is active, a signal to switch memories received 50 ms or less after another will be ignored.
- Even if “by signal” is selected, this setting will not change when a hold or zone definition hold is active.

- Turning the power OFF while writing setting values will not only cause the values to not be recorded, it might also corrupt the memory. Do not turn the unit off when a setting screen is open.

## 9-2. D/A Converter

The D/A Converter allows for analog output that corresponds to the unit indicator value.

The D/A output circuit is isolated from the main unit circuit.

The analog output range is either 0–±10V voltage output or 4–20mA current output. Set the maximum voltage output between ±1 V and ±10 V in 1V steps using the D/A Max. Voltage setting.

You can achieve analog output from zero (0V, 4mA) to full scale (±10V, 20mA) according to the digital values set using D/A Zero and D/A Full Scale settings.

The zero point and full scale cannot be changed separately for current output and voltage output.

The conversion speed is 4000 times/second.

The D/A conversion rate does not change even during high-speed sampling (fast sampling).

For voltage output, connect an external device with a load resistance of 2 kΩ or more to V-OUT and COM.

For current output, connect an external device with a load resistance, including cable wiring resistance, of 350 Ω or less to I-OUT and COM.

- Voltage output or current output can be used. They cannot both be output at the same time.

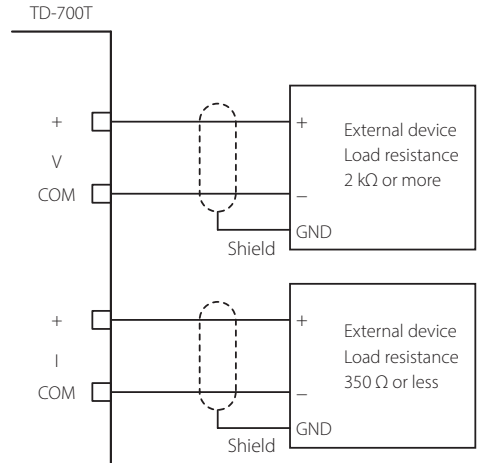

See “1-4. D/A output connectors” on page 13 for terminal numbers.

## 9. System Settings

### 9-2-1. D/A Zero

Set the indicator value that you want to output for D/A Zero (0V voltage or 4mA current).

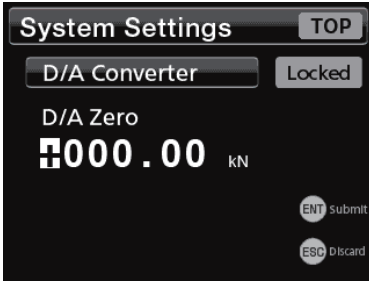

### 9-2-2. D/A Full Scale

With the "9-2-1. D/A Zero" value as the reference, set the span for the indicator values output to D/A.

When the "9-2-1. D/A Zero" and "9-2-2. D/A Full Scale" setting values are added, the "9-2-4. D/A Max. Voltage" setting value (20 mA when in electrical current mode) is output.

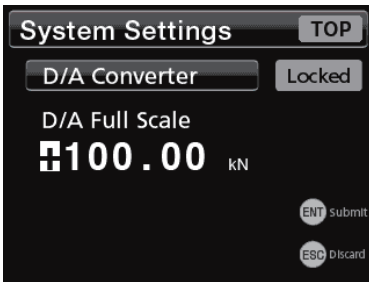

The following is an example of when "9-2-4. D/A Max. Voltage" is set to 10V.

Setting example 1

D/A Zero	000.00
D/A Full Scale	100.00
Indicator value	D/A output
100.00	10 V (20 mA)
0.00	0 V (4 mA)
-100.00	-10 V (-- mA)

Setting example 2

D/A Zero	020.00
D/A Full Scale	100.00
Indicator value	D/A output
120.00	10 V (20 mA)
20.00	0 V (4 mA)
-80.00	-10 V (-- mA)

Setting example 3

D/A Zero	020.00
D/A Full Scale	-100.00
Indicator value	D/A output
120.00	-10 V (-- mA)
20.00	0 V (4 mA)
-80.00	10 V (20 mA)

Setting example 4

D/A Zero	-010.00
D/A Full Scale	020.00
Indicator value	D/A output
10.00	10 V (20 mA)
-10.00	0 V (4 mA)
-30.00	-10 V (-- mA)

### ATTENTION

If calibration is conducted, when the rated capacity is confirmed, the D/A Full Scale value will be set as its value.

### 9-2-3. D/A Output Mode

Select voltage or current

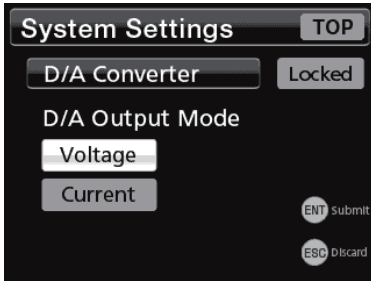

### 9-2-4. D/A Max. Voltage

Set voltage (limiter)

- The output has an over range of about 10% of the set value. The load also uses the same output voltage range. For example, when set to 5 V, the D/Z output voltage range will be about -5.5 V to +5.5 V, and +5 V will be output when the "9-2-1. D/A Zero" and "9-2-2. D/A Full Scale" setting values are added.

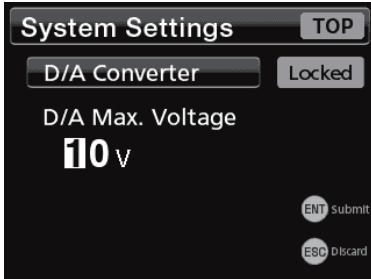

### 9-2-5. D/A CAL TEST

The output value for the method selected in D/A Output Mode can be changed.

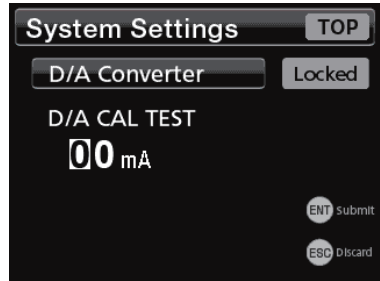
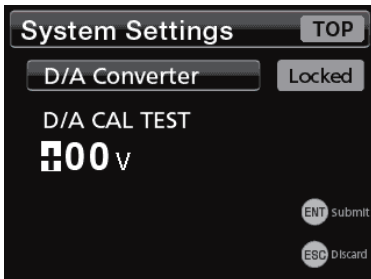

#### NOTE

When the D/A CAL TEST screen is open, the voltage and current values shown on the display are output from the D/A. The D/A output changes each time a setting is changed. If a value outside the D/A range (outside the range indicated in the specifications) is set, the setting value change will be ignored and the D/A output will not change. For example, when set to 5 V, if the setting is changed to 15 V, that value will be ignored and the D/A output will remain 5 V.

## 9-3. Lock

### 9-3-1. Cal. Value Lock

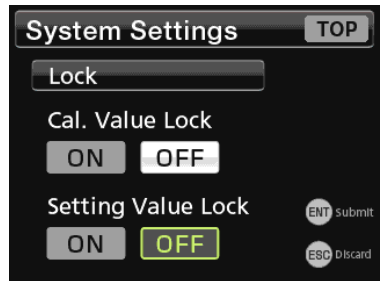

See "4-10. Setting value list" on page 32 for information about settings that cannot be changed when Cal. Value Lock is ON.

## 9. System Settings

### 9-3-2. Setting Value Lock

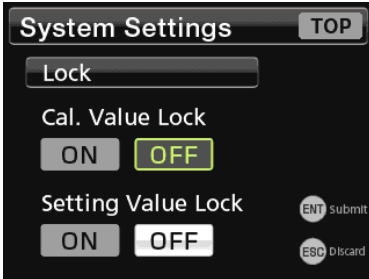

See “4-10. Setting value list” on page 32 for information about settings that cannot be changed when Setting Value Lock is ON.

### 9-4. Home Screen

You can select the Home Screen that first appears when the unit is turned on.

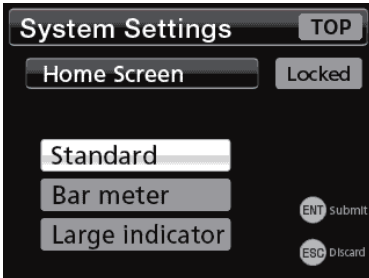

### 9-5. Brightness

Adjust the brightness of the LCD screen backlight.

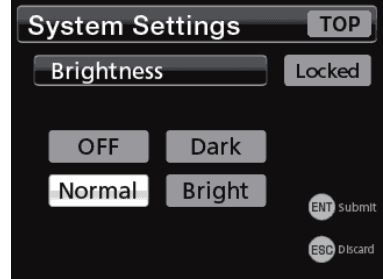

Select Bright, Normal, Dark or OFF.

#### NOTE

Even when set to OFF, the backlight will light at normal brightness for 5 seconds whenever you press a button. Button operations are only enabled when the backlight is lit.

### 9-6. Power Save Time

Set the amount of time without any button operations until the backlight turns off.

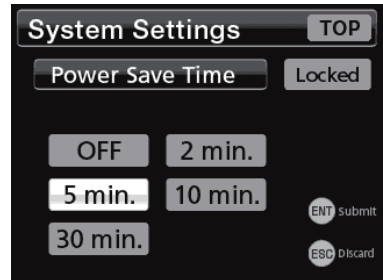

Select OFF, 2 min., 5 min., 10 min. or 30 min.

#### NOTE

The brightness at this time is according to the Brightness setting. Button operations are only enabled when the backlight is lit.

### 9-7. Languages

You can select the language used for display.  
The options are Japanese and English.

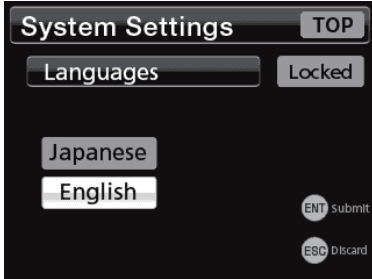

### 9-8. Reset to the Factory Settings

You can restore settings to their default values (initialize them).

Select **Execute** and press the **ENT** button.

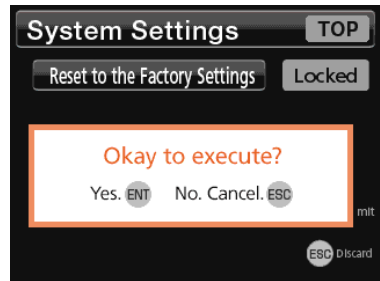

After resetting to defaults completes, the Home Screen opens.

#### NOTE

Only the current Setting Memory is reset.  
Items in "4-10-1. Calibration" on page 32 are not reset.

#### ATTENTION

Always turn the unit off once after executing the "Reset to the Factory Settings" command.

# 10. TEDS Settings

By connecting a sensor that supports IEEE1451.4 Transducer Electronic Data Sheets (TEDS) to the unit, the Rated Output stored in the sensor can be loaded and this can be applied to calibration of the indicator with this function.

In addition, the value calibrated by the unit itself can be loaded to the TEDS sensor or its original value can be restored.

This function supports functions with TEDS sensors as shown below.

Note, however that equipment with TEDS memory includes both 1kbit and 4kbit devices, but the unit only supports 4kbit.

TEDS standard			
IEEE 1451.4 (V0.9)	IEEE1451.4 (V1.0)		
	Template ID		
	Bridge Sensors (33)	Strain Gauge (35)	Other
-	✓✓	✓	-
✓✓ TEDS calibration, TEDS data writing and TEDS data restoration supported ✓ TEDS calibration supported - Not supported			

## 10-1. TEDS Data Change

The current calibration values (rated output and rated capacity) and calibration date will be written to the TEDS memory. The indicator unit will not be written.

**1 Press the FNC button to open the Function Menu, and select in order TEDS Settings → TEDS Data Change.**

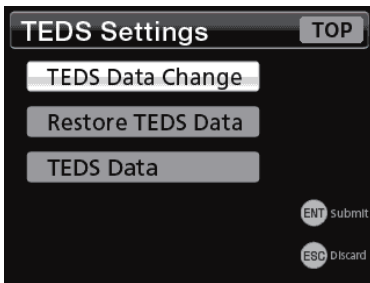

**2 Input 00015 and press the ENT button twice.**

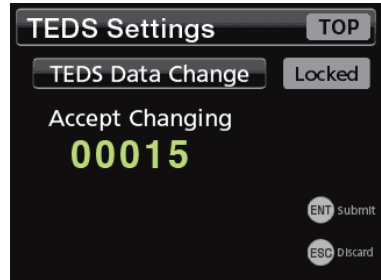
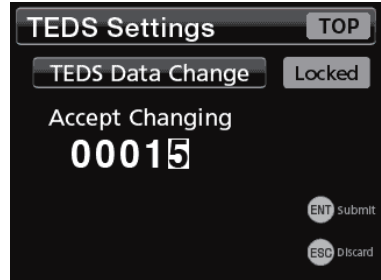

### NOTE

- This value must be input to prevent accidental data change.
- Press the ESC button to cancel and exit setting mode.

**3 Input the Calibration Date, and press the ENT button twice.**

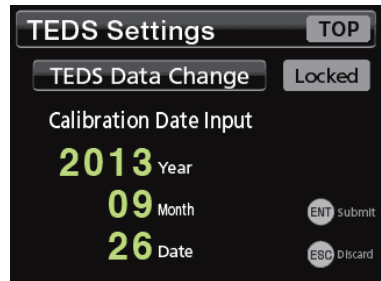

While the calibration value is being written, "Writing Cal. Data" appears.

After the calibration value has been written, TEDS Settings appears and is ready for button input. Press the ESC button to exit setting mode.

## 10-2. Restore TEDS Data

Use this to restore the factory default calibration value of a sensor to which data was written using the TEDS Data Change procedures above.

- 1 Press the FNC button to open the Function Menu, and select in order TEDS Settings → Restore TEDS Data.

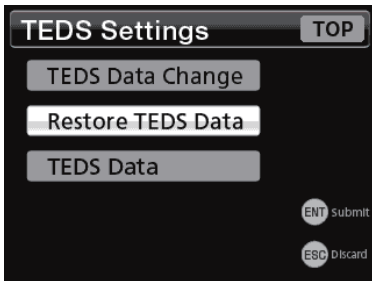

- 2 Input "00015".



### NOTE

- This value must be input to prevent accidental data change.
- Press the ESC button to cancel and exit setting mode.

- 3 Press the ENT button to restore the data from the TEDS memory. "Executing" appears while this occurs.

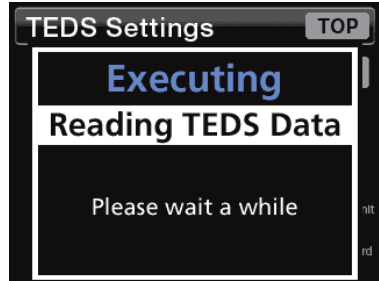

When writing the TEDS memory restoration data completes, the rated output (mV/V) and rated capacity are shown so you can check the values.

### NOTE

- Press the ESC button to cancel and exit setting mode.

- 4 Press the ENT button to write the data to the TEDS memory. "Writing TEDS Data" appears while this occurs.

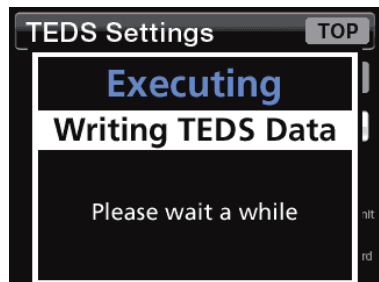

## 10. TEDS Settings

---

### 10-3. TEDS Data

Select TEDS Data to show the following items.

Serial number

Rated capacity unit

Rated capacity

Rated output

Bridge Element Impedance

Max. Exc. Level

Calibration Date

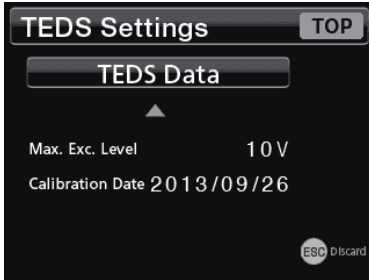
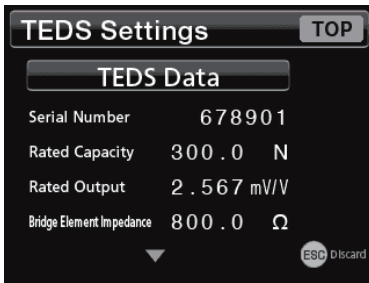

Press the ESC button to exit TEDS data display mode.



# 11. CC-Link Settings

In this chapter we explain the CC-Link functions of the TD-700T (CCL).

In order to resell the TD-700T (CCL), membership registration in the CC-Link Partner Association is necessary.

## 11-1. CC-Link overview

### Version

Ver. 1.10

### Station type

Remote device station

## 11-2. Connections

### 11-2-1. CC-Link terminals

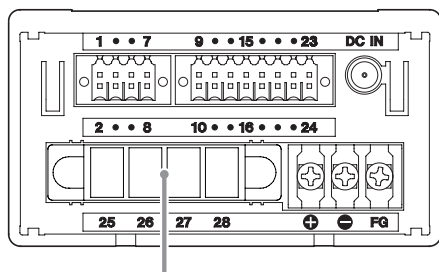

CC-Link terminals

Terminal number	Signal name	Wire color
25	DA	Blue
26	DB	White
27	DG	Yellow
28	SLD	Connection line (shielded)

### 11-2-2. Inserting and removing CC-Link terminal bank

- You can remove the terminal bank from the main unit by loosening the two black screws at the ends of the terminal bank and pulling it out.
- Always disconnect the power before removing or installing a terminal bank.

### 11-2-3. Connecting the CC-Link terminals

- Use CC-Link specialty cables to make connections. Connect the shield to the SLD connector.
- If a TD-700T (CCL) will be the unit at both ends, connect terminators to both DA and DB.
- Always disconnect the power before working with wiring.
- The recommended torque for the CC-Link terminal screws (M3.5) and attachment screws is 0.69 N·m  $\approx$  7 kgf·cm.
- After wiring, attach the terminal bank cover.
- Refer to the Install Guide issued by the CC-Link Partner Association.

#### CAUTION

For the CC-Link connector, use the included connector. Do not use any other connector because doing so could make it unsafe.

Connect the CC-Link terminals of devices that support it to the CC-Link terminal bank.

- The wire color is the color of the insulation used by the CC-Link cable.

## 11. CC-Link Settings

### 11-3. Setting value list

Item	Settings	Format	Default value	Setting range/options	Calibration value lock	Setting value lock	Setting value memory
CC-Link	Station Type	Options	Ver.1.10 4 Stations	Ver.1.10, 4 Stations Ver.1.10, 2 Stations Ver.1.10, 1 Station		✓	✓
	Station Number	Input	1	1 – 64		✓	✓
	Transmission Speed	Options	10 Mbps	156 kbps 625 kbps 2.5 Mbps 5 Mbps 10 Mbps		✓	✓
	Return Data Format	Options	BCD	BCD Binary		✓	✓
	Select Memory by	Options	Manual	Manual CC-Link		✓	✓
	Save Setting	Options	Discard	Discard Save		✓	✓
	Link Status	Display		"RUN", "SD", "RD", "ERR" displayed			

## 11-4. Settings

CC-Link setting items are added to the system settings screen for the TD-700T (CCL).

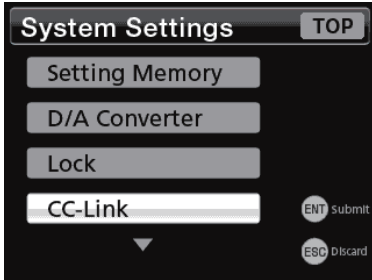

### 11-4-1. Station Type

Set the number of CC-Link occupied stations.

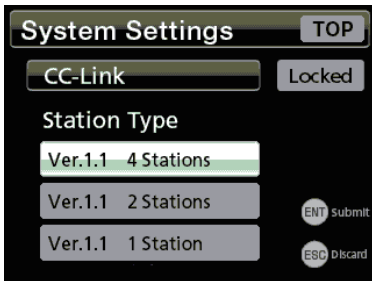

The maximum station number is 64 when one station is occupied and 61 when four stations are occupied.

If the set station number would cause the maximum number of stations to be exceeded, the station number will automatically be set to the highest possible number.

### 11-4-2. Station Number

This can be set between 1 and 64. Consider the number of occupied stations, and set this so that it does not overlap with other stations.

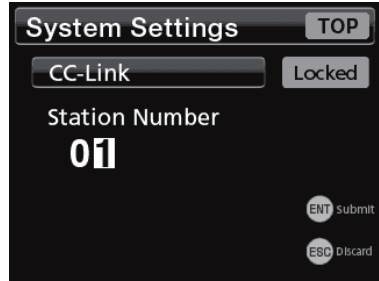

### 11-4-3. Transmission Speed

Set the CC-Link transmission speed. The maximum transmission distance changes according to the transmission speed.

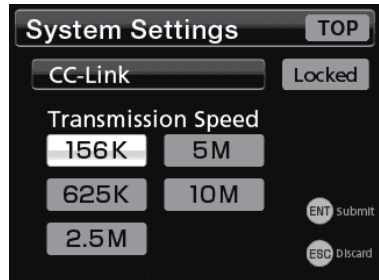

#### NOTE

Transmission speed	Maximum transmission distance
156 kbps	1200 m
625 kbps	900 m
2.5 Mbps	400 m
5 Mbps	160 m
10 Mbps	100 m

## 11. CC-Link Settings

### 11-4-4. Return Data Format

Select the format of indicator values (hold and real-time values) returned by the remote resistor (RWr).

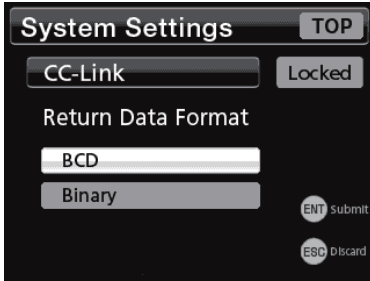

See "Real-time value/hold value format" on page 85.

### 11-4-5. Select Memory by

Select whether switching the setting value memory is done using the main unit settings (System Settings → Setting Memory by menu) or by CC-Link remote output (RY) "Memory selection 1 and 2".

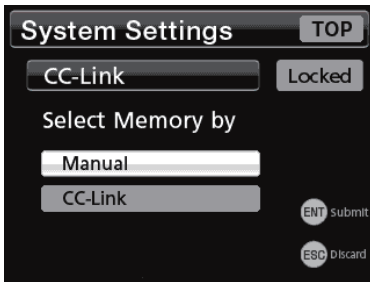

### 11-4-6. Save Setting

Set whether or not setting values that are changed by external commands, for example, are stored in the internal ROM.

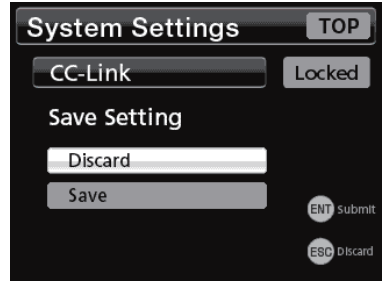

If set to "Discard", the previous settings will be restored when the unit is turned off. (If the Function Menu is opened manually or if the Setting Memory number is changed, this will be stored in the internal ROM.)

When set to "Save", the settings will be retained even when the unit is turned off. However, not only will command response be delayed, changing the settings frequently could result in exceeding the 100,000 write limit of the internal ROM.

### 11-4-7. Link Status

This shows the CC-Link link status in real time.

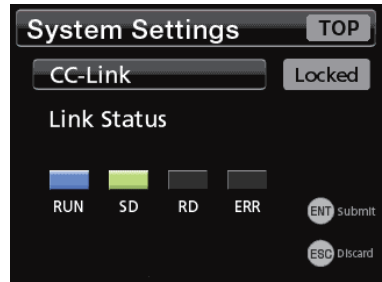

LED name	Lit	Blinking	Unlit
RUN	Normal	—	Transmission not possible Resetting
SD	Transmitting	—	—
RD	Receiving	—	—
ERR	Setting abnormal CRC error Malfunction		Normal

## 11-5. Address map

### ATTENTION

Hold values and real-time values returned by this unit use the following format.

#### Real-time value/hold value format

MSB	4 bit	Status	See table below
	4 bit	Decimal point position	0: none / 1: 0.0 / 2: 0.00 / 3: 0.000 / 4: 0.0000
	4 bit	Reserved	0
	4 bit	5th digit	BCD/binary
	4 bit	4th digit	BCD/binary
	4 bit	3rd digit	BCD/binary
	4 bit	2nd digit	BCD/binary
LSB	4 bit	1st digit	BCD/binary

#### Status

Status	Bit 3	Bit 2	Bit 1	Bit 0
0	Plus (+)	BCD display	No input over	Real-time value
1	Minus (-)	Binary display	Input over	Hold value

- For binary display, two's complement is used.

### 11-5-1. Remote resistor

#### Ver.1.10, 4 Stations

Station	TD-700T (CCL) → Master station			Master station → TD-700T (CCL)				
	Remote input	Address <sup>1</sup>	Name	Remote output	Address <sup>1</sup>	Name	Area	
1	RWr0000	0x2E0	Hold value <sup>2</sup>	RWw0000	0x1E0	High high limit (HH)	Exclusive area	
	RWr0001	0x2E1		RWw0001	0x1E1			
	RWr0002	0x2E2	Real-time value <sup>2</sup>	RWw0002	0x1E2	High limit (HI)		
	RWr0003	0x2E3		RWw0003	0x1E3			
2	RWr0004	0x2E4	Reserved	RWw0004	0x1E4	Low limit (LO)		
	RWr0005	0x2E5		RWw0005	0x1E5			
	RWr0006	0x2E6		Error code	RWw0006	0x1E6		Low low limit (LL)
	RWr0007	0x2E7		Sub error code	RWw0007	0x1E7		
3	RWr0008	0x2E8	Reserved	RWw0008	0x1E8	Nearly Zero		
	RWr0009	0x2E9		RWw0009	0x1E9			
	RWr000A	0x2EA		Reserved	RWw000A	0x1EA		
	RWr000B	0x2EB			RWw000B	0x1EB		
4	RWr000C	0x2EC	Command data	RWw000C	0x1EC	Command data	Common area	
	RWr000D	0x2ED		RWw000D	0x1ED			
	RWr000E	0x2EE	Command No.	RWw000E	0x1EE	Command No.		
	RWr000F	0x2EF	Reserved	RWw000F	0x1EF	Reserved		

## 11. CC-Link Settings

### Ver.1.10, 2 Stations

Station	TD-700T (CCL) → Master station			Master station → TD-700T (CCL)			
	Remote input	Address <sup>1</sup>	Name	Remote output	Address <sup>1</sup>	Name	Area
1	RWr0000	0x2E0	Real-time value/hold value <sup>2</sup>	RWw0000	0x1E0	High limit (HI)	Exclusive area
	RWr0001	0x2E1		RWw0001	0x1E1		
	RWr0002	0x2E2	Error code	RWw0002	0x1E2	Low limit (LO)	
	RWr0003	0x2E3	Sub error code	RWw0003	0x1E3		
2	RWr0004	0x2E4	Command data	RWw0004	0x1E4	Command data	Common area
	RWr0005	0x2E5		RWw0005	0x1E5		
	RWr0006	0x2E6	Command No.	RWw0006	0x1E6	Command No.	
	RWr0007	0x2E7	Reserved	RWw0007	0x1E7	Reserved	

- Command numbers set for the Exclusive and Common areas are 4-digit BCD and command data are signed 32-bit integers.

### Ver.1.10, 1 Station

Station	TD-700T (CCL) → Master station			Master station → TD-700T (CCL)			
	Remote input	Address <sup>1</sup>	Name	Remote output	Address <sup>1</sup>	Name	Area
1	RWr0000	0x2E0	Real-time value/hold value <sup>2</sup>	RWw0000	0x1E0	Reserved	/
	RWr0001	0x2E1		RWw0001	0x1E1		
	RWr0002	0x2E2	Error code	RWw0002	0x1E2		
	RWr0003	0x2E3	Sub error code	RWw0003	0x1E3		

<sup>1</sup> The buffer address is shown when set to Station 1.

<sup>2</sup> This is returned in the real-time value/hold value format.

### 11-5-2. Remote input and output

#### Remote input resistor (TD-700T (CCL) → Master station)

Name		Content
Indicator value (4 stations occupied)	Hold value/ real-time value	The held indicator value is returned. Unless held, the real-time value is returned. The input real-time value is returned.
Indicator value (1 or 2 stations occupied)	Hold value/ real-time value	Depending on the hold/real selection (RY0nF), either the hold value or the real-time value is returned. For ordinary indicator display, select the hold value.
Error code		The code for the error that occurred is returned. (See the error code table.)
Sub error code		The sub error code attached to the error code is returned. (See the error code table.)
Command data		The indicator response data for the command number is returned.
Command No.		The command number requested by the indicator is returned by BCD.

#### Remote output resistor (Master station → TD-700T (CCL))

Name		Content
High high limit (HH)	Exclusive area (Use Exclusive area request to set)	Store the high high limit (HH) set directly using Exclusive area requests.
High limit (HI)		Store the high limit (HI) set directly using Exclusive area requests.
Low limit (LO)		Store the low limit (LO) set directly using Exclusive area requests.
Low low limit (LL)		Store the low low limit (LL) set directly using Exclusive area requests.
Nearly Zero		Store the nearly zero range value set directly using Exclusive area requests.
Command data	Common area (Use Common area request to set)	Store command parameter designated by command number.
Command No.		Store the execution command number by BCD using Common area requests.

- Refer to the explanations for Exclusive area and Common area settings.

# 11. CC-Link Settings

## Ver.1.10, 4 Stations

Station	TD-700T (CCL) → Master station			Master station → TD-700T (CCL)		
	Remote input	Address <sup>1</sup>	Content	Remote output	Address <sup>1</sup>	Content
1	RX0000	0x0E0	Exclusive area response	RY0000	0x160	Exclusive area request
	RX0001			RY0001		
	RX0002		Common area response	RY0002		Common area request
	RX0003		R/W (response)	RY0003		R/W (request)
	RX0004			RY0004		
	RX0005			RY0005		
	RX0006		CPU operating properly	RY0006		
	RX0007		Decimal point position 1	RY0007		
	RX0008		Decimal point position 2	RY0008		
	RX0009		Decimal point position 3	RY0009		
	RX000A			RY000A		
	RX000B			RY000B		
	RX000C			RY000C		
	RX000D			RY000D		
	RX000E			RY000E		
	RX000F			RY000F		
	RX0010	0x0E1	High high limit (HH)	RY0010	0x161	D/Z
	RX0011		High limit (HI)	RY0011		Clear Digital Zero
	RX0012		OK (OK)	RY0012		CLEAR
	RX0013		Low limit (LO)	RY0013		JUDGE
	RX0014		Low low limit (LL)	RY0014		HOLD
	RX0015		Nearly Zero	RY0015		Display (normal)
	RX0016		Zero Tracking	RY0016		Display (barmeter)
	RX0017		Stable	RY0017		Display (value)
	RX0018		When holding	RY0018		Display (static strain)
	RX0019		When zone definition hold is active	RY0019		Operation locked
	RX001A		Memory selection 1 (response)	RY001A		Memory selection 1 <sup>2</sup>
	RX001B		Memory selection 2 (response)	RY001B		Memory selection 2 <sup>2</sup>
	RX001C		Zero balance error	RY001C		
	RX001D		Calibration error	RY001D		
	RX001E		±FULL	RY001E		
	RX001F		OVER FULL	RY001F		
2	RX0020	0x0E2	Reserved	RY0020	0x162	Reserved
3	RX005F	0x0E5		RY005F	0x165	
4	RX0060	0x0E6	Reserved	RY0060	0x166	Reserved
	RX006F			RY006F		
	RX0070			RY0070		
	RX0079	0x0E7	Reserved	RY0079	0x167	Reserved
	RX007A		Error status flag <sup>3</sup>	RY007A		
	RX007B		Remote READY	RY007B		
	RX007C			RY007C		
	RX007F		Reserved	RY007F		



## Ver.1.10, 2 Stations

Station	TD-700T (CCL) → Master station			Master station → TD-700T (CCL)			
	Remote input	Address <sup>1</sup>	Content	Remote output	Address <sup>1</sup>	Content	
1	RX0000	0x0E0	Exclusive area response	RY0000	0x160	Exclusive area request	
	RX0001			RY0001			
	RX0002		Common area response	RY0002		Common area request	
	RX0003		R/W (response)	RY0003		R/W (request)	
	RX0004			RY0004			
	RX0005			RY0005			
	RX0006		CPU operating properly	RY0006			
	RX0007		Decimal point position 1	RY0007			
	RX0008		Decimal point position 2	RY0008			
	RX0009		Decimal point position 3	RY0009			
	RX000A			RY000A			
	RX000B			RY000B			
	RX000C			RY000C			
	RX000D			RY000D			
	RX000E			RY000E			
	RX000F			RY000F			
	RX0010	0x0E1	High high limit (HH)	RY0010	0x161	D/Z	
	RX0011		High limit (HI)	RY0011		Clear Digital Zero	
	RX0012		OK (OK)	RY0012		CLEAR	
	RX0013		Low limit (LO)	RY0013		JUDGE	
	RX0014		Low low limit (LL)	RY0014		HOLD	
	RX0015		Nearly Zero	RY0015		Display (normal)	
	RX0016		Zero Tracking	RY0016		Display (bar meter)	
	RX0017		Stable	RY0017		Display (value)	
	RX0018		When holding	RY0018		Display (Static Strain)	
	RX0019		When zone definition hold is active	RY0019		Main unit operation locked	
	RX001A		Memory selection 1 (response)	RY001A		Memory selection 1 <sup>2</sup>	
	RX001B		Memory selection 2 (response)	RY001B		Memory selection 2 <sup>2</sup>	
	RX001C		Zero balance error	RY001C			
	RX001D		Calibration error	RY001D			
	RX001E		±FULL	RY001E			
	RX001F		OVER FULL	RY001F		Hold/real-time selection	
2	RX0020	0x0E2	Reserved	RY0060	0x162	Reserved	
	RX002F			RY006F			
	RX0030	0x0E3	Reserved	RY0030	0x163	Reserved	
	RX0039			RY0039			
	RX003A			Error status flag			RY003A
	RX003B			Remote READY			RY003B
	RX003C						RY003C
				Reserved			
	RX003F						RY003F

# 11. CC-Link Settings

## Ver.1.10, 1 Station

Station	TD-700T (CCL) → Master station			Master station → TD-700T (CCL)		
	Remote input	Address <sup>1</sup>	Content	Remote output	Address <sup>1</sup>	Content
1	RX0000	0x0E0	High high limit (HH)	RY0000	0x160	D/Z
	RX0001		High limit (HI)	RY0001		Clear Digital Zero
	RX0002		OK (OK)	RY0002		CLEAR
	RX0003		Low limit (LO)	RY0003		JUDGE
	RX0004		Low low limit (LL)	RY0004		HOLD
	RX0005		Nearly Zero	RY0005		Display (normal)
	RX0006		Zero Tracking	RY0006		Display (bar meter)
	RX0007		Stable	RY0007		Display (value)
	RX0008		When holding	RY0008		Display (static strain)
	RX0009		When zone definition hold is active	RY0009		Main unit operation locked
	RX000A		Memory selection 1 (response)	RY000A		Memory selection 1 <sup>2</sup>
	RX000B		Memory selection 2 (response)	RY000B		Memory selection 2 <sup>2</sup>
	RX000C		Zero balance error	RY000C		
	RX000D		Calibration error	RY000D		
	RX000E		±FULL	RY000E		
	RX000F		OVER FULL	RY000F		Hold/real-time selection
	RX0010		0x0E1	Reserved		RY0010
RX0019		RY0019				
RX001A	Error status flag	RY001A				
RX001B	Remote READY	RY001B				
RX001C		RY001C				
	Reserved					
RX001F		RY001F				

<sup>1</sup> The buffer address is shown when set to station 1.

<sup>2</sup> When using memory selection 1 and 2, set the CC-Link "Select Memory by" to "CC-Link".

<sup>3</sup> This becomes ON when a system error occurs.

### 11-5-3. Remote input and output

#### Remote input resistor (TD-700T (CCL) → Master station)

Name	Content
Exclusive area response	This becomes ON when data writing for the Exclusive area completes. After request becomes OFF, response also becomes OFF.
Common area response	This becomes ON when execution of a Common area command completes. After request becomes OFF, response also becomes OFF.
R/W (response)	The same value as the Common area command R/W (request) is returned.
CPU operating properly	During proper operation, turns ON/OFF at intervals of about 0.5 seconds.
Decimal point positions 1–3	These show the decimal point positions (0: none / 1: 0.0 / 2: 0.00 / 3: 0.000 / 4: 0.0000)
High high limit (HH)	This becomes ON if the indicator value is larger than the set high high limit (HH) value.
High limit (HI)	This becomes ON if the indicator value is larger than the set high limit (HI) value.
OK	This becomes ON if the indicator value is within the OK range.
Low limit (LO)	This becomes ON if the indicator value is smaller than the set low limit (LO) value.
Low low limit (LL)	This becomes ON if the indicator value is smaller than the set low low limit (LL) value.
Nearly Zero	This becomes ON if the indicator is judged to be in a range that is considered equivalent to zero.
Zero Tracking	This becomes ON during zero tracking.
Stable	This becomes ON when the indicator is detected to be stable. (See Motion Detect.)
Holding	This becomes ON when holding.
Zone definition hold active	This becomes ON when zone definition hold is active (hold locked).
Memory selections 1–2 (response)	This shows the currently selected memory number. (0: Memory 1, 1: Memory 2, 2: Memory 3, 3: Memory 4)
Zero balance error	This is shown when an error occurred in zero point calibration.
Calibration error	This is shown when an error occurred in calibration.
±FULL	This becomes ON when the indicator value is larger than the set maximum display value.
OVER FULL	This becomes ON when the input value exceeds the maximum input value of the AD converter.
Error status flag	This becomes ON when a system error occurs. When ON, Remote READY becomes OFF.
Remote READY	This becomes ON when the device status is normal.

## 11. CC-Link Settings

### Remote output resistor (Master station → TD-700T (CCL))

Name	Content
Exclusive area request	Turn this ON when setting the Exclusive area. Before turning this OFF, confirm the Exclusive area response is ON.
Common area request	Turn this ON when issuing a Common area command. Before turning this OFF, confirm the Common area response is ON.
R/W (request)	Turn this ON when issuing a Common area command by reading (R) and OFF when issuing it by writing (W).
D/Z	Sets the positive edge indicator value digitally to 0.
Clear Digital Zero	Clears the digital zero with the positive edge.
CLEAR	Ends holds other than sample-and-hold with the positive edge.
JUDGE	Enables judgment output only during the ON interval. (Effective when JUDGE is enabled.)
HOLD	Controls hold start and stop with the positive edge. (Level control is not supported.)
Display (normal)	The positive edge activates normal display.
Display (barmeter)	The positive edge activates bar meter display.
Display (value)	The positive edge activates value display.
Display (Static Strain)	The positive edge activates static strain display. During static strain display, the positive edge reactivates normal display mode.
Main unit operation locked	Operation of the main unit is locked during the ON interval and unlocked during the OFF interval.
Memory selections 1–2	Switches setting value memories 1–4. (When CC-Link is selected with the Select Memory by.)

## 11-6. Setting procedures

### 11-6-1. Writing Exclusive area values to the device

Confirm that all Exclusive and Common area requests and responses are off before conducting the following.

When you turn the master station "Exclusive area request" (RYn0) on, this unit will write the Exclusive area data to the device.

When this unit completes writing Exclusive area data, "Exclusive area response" (RXn0) will become ON.

After the master station confirms that the "Exclusive area response" (RXn0) from this unit is ON, turn the "Exclusive area request" (RYn0) OFF.

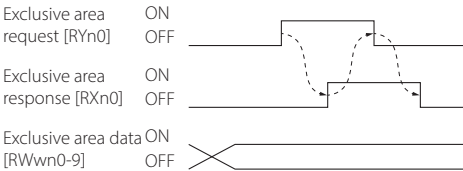

### 11-6-2. Reading, writing and operations using commands in the Common area

Confirm that all Exclusive and Common area requests and responses are off before conducting the following.

When you turn the master station "Common area request" (RYn2) ON, this unit will execute a command according to the R/W request (RYn3) and command number (RWwnE).

The command will use RWwnC-D command data to read or write the unit's data or execute the specified operation.

When this unit completes executing the command, "Common area response" (RXn2) will become ON.

After the master station confirms that the "Common area response" (RXn2) from this unit is ON, turn the "common area request" (RYn2) OFF.

#### NOTE

If a command ends with an error, the RWrnE Command No. response will be 0xFFFF.

#### Writing operation R/W = OFF

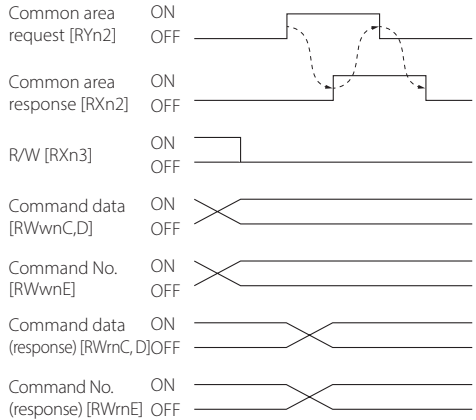

#### Reading operation R/W = ON

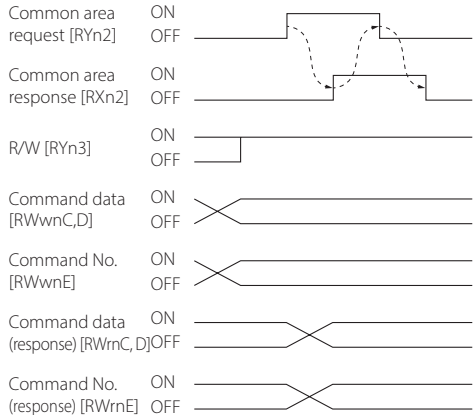

#### NOTE

- The values that handle command data are all two's complement. Input values for the valid number of digits, excluding the decimal point.
- After a command is executed, check the command number response or the error code to confirm whether or not the command has been executed properly.
- Commands will not be executed properly when a settings menu screen is open.

## 11. CC-Link Settings

### 11-6-3. Command

Function	Group	Setting name	Command No.	R/W	Default value	Command data (setting value)
Execute (Immediate)*		Clear pop-up	0000	W		00
		Digital Zero	0000	W		10
		Clear Digital Zero	0000	W		11
		HOLD ON	0000	W		12
		HOLD OFF	0000	W		13
		HOLD LOCK	0000	W		14
		HOLD CLEAR	0000	W		15
		Zero Balancing	0000	W		16
		Switch to Home Screen	0000	W		17
		Switch to bar meter screen	0000	W		18
		Switch to value screen	0000	W		19
		Switch to static strain screen	0000	W		20

\*RS-485 command time

## 11. CC-Link Settings

Function	Group	Setting name	Command No.	R/W	Default value	Command data (setting value)			
Calibration		Excitation Voltage	1001	R/W	2.5 V	0: 2.5 V 1: 10 V			
		Decimal point position	1002	R/W	2	0: none / 1: 0.0 / 2: 0.00 / 3: 0.000 / 4: 0.0000			
		Zero point input calibration	1003	R/W	0	-3100 – 3100 (-3.100 – 3.100 mV/V)			
		Zero Balancing	1004	R/W	0	When W, command data will be ignored and the zero point will be calibrated. When R, the current setting value will be returned as $\mu\text{V/V}$ .			
		Remote Sense/TEDS	1005	R/W	Remote Sense enabled/ TEDS disabled	0: Remote Sense disabled/ TEDS enabled 1: Remote Sense enabled/ TEDS disabled			
	Equivalent Input Calibration	Rated Output	1101	R/W	2000	300 – 3200 (0.300–3.200 mV/V)			
		Rated Capacity	1102	R/W	10000	00001 – 99999			
	Actual Load Calibration	Rated Capacity	1103	R/W	10000	00001 – 99999			
		TEDS calibration	TEDS calibration	1104	W				
	D/A Converter	D/A Output Mode	1301	R/W	Voltage	0: Voltage 1: Current			
		D/A Max. Voltage	1302	R/W	10 V	1 V–10 V			
		D/A Zero	1303	R/W	000.00	-99999 – 99999			
		D/A Full Scale	1304	R/W	100.00	-99999 – 99999			
	Display	Select EU		1401	R/W	N	0: None    12: dN 1: N        13: lbf 2: kN      14: klbf 3: kPa      15: Pa 4: MPa     16: psi 5: g        17: mBar 6: kg       18: Bar 7: sht      19: m/s <sup>2</sup> 8: ton      20: G 9: mN·m    21: Gal 10: N·m     22: mm 11: kN·m    23: $\mu\text{st}$		
			Select Min. Grid		1402	R/W	1	0: 1 1: 2 2: 5 3: 10	
				Select Disp. Times		1403	R/W	4	0: 4 times 1: 6 times 2: 10 times 3: 20 times
					Max. Disp. Value	1404	R/W	11000	00000 – 99999
					Sensor input logic	1405	R/W	Standard	0: Standard 1: Reversed

## 11. CC-Link Settings

Function	Group	Setting name	Command No.	R/W	Default value	Setting value
Condition Setting	Filter	Select LPF	2001	R/W	100	0: OFF
						1: 3 Hz
						2: 10 Hz
	3: 30 Hz					
	4: 100 Hz					
	5: 300 Hz					
	6: 1000 Hz					
	Filter	Select Num. of Moving Avg.	2002	R/W	OFF	0: OFF
						1: 16 times
						2: 32 times
	3: 64 times					
	4: 128 times					
	5: 256 times					
	6: 512 times					
	7: 1024 times					
	8: 2048 times					
Motion Detect	Auto Digital Filter	2003	R/W	ON	0: OFF	
					1: ON	
Zero Tracking	Time	2101	R/W	1.5	0 – 99 (changed to 0.0 – 9.9 seconds internally)	
		2102	R/W	000.05	00000 – 00999	
Digital Zero	Width	2201	R/W	0.0	0 – 99 (changed to 0.0 – 9.9 seconds internally)	
		2202	R/W	000.00	00000 – 00999	
Digital Zero Offset	Enable Digital Zero	2301	R/W	ON	0: OFF 1: ON	
		2302	R/W	99999	00000 – 99999	
Select Data Output	Digital Zero Limit Value	2303	R/W	00000	–19999 – 19999	
		2401	R/W	Displayed output	0: Hold value is output in coordination with display 1: Input is output as is	



## 11. CC-Link Settings

Function	Group	Setting name	Command No.	R/W	Default value	Setting value	
Comparison Setting	Comp. Value Setting	High high limit input (HH)	3001	R/W	999.99	-99999 – 99999	
		High limit input (HI)	3002	R/W	100.00	-99999 – 99999	
		Low limit input (LO)	3003	R/W	50.00	-99999 – 99999	
		Low low limit input (LL)	3004	R/W	000.00	-99999 – 99999	
	Comp. Pattern Setting			3005	R/W	LL/LO/OK/ HI/HH	0: OK/LL/LO/HI/HH 1: LL/OK/LO/HI/HH 2: LL/LO/OK/HI/HH 3: LL/LO/LO/OK/HH 4: LL/LO/LO/HH/OK
		Comp. Mode Setting		3006	R/W	Compare Always	0: Compare always 1: Compare during stable 2: Compare except nearly zero 3: Compare during stable except nearly zero 4: Compare during held 5: Disable comparison
			HH LL Limit Enable	3007	R/W	Disable	0: Disable 1: Enable
			Hysteresis	3101	R/W	000.00	00000–99999
	Judge Signal		3102	R/W	Disable	0: Disable 1: Enable	
	Comp. Output Pattern		3103	R/W	Standard Output	0: Standard Output 1: Area Output	
	Nearly zero (range equivalent to zero)	3104	R/W	001.00	00000 – 09999		
	Bar meter zero position	3105	R/W	Automatic	0: Automatic 1: Left-edge fixed		
	Hold Function Setting	Hold Mode		4001	R/W	SAMPLE	0: OFF 1: SAMPLE 2: PEAK 3: BOTTOM 4: AVERAGE 5: PEAK to PEAK 6: PEAK and BOTTOM
Times of Average			4002	R/W	1	1 – 999 times	
Fast Sampling Mode			4003	R/W	OFF	0: OFF 1: ON	
External Hold Mode			4004	R/W	Level	0: Level 1: Pulse	
CLEAR Signal			4005	R/W	Enable	0: Disable 1: Enable	
Zone Definition			4006	R/W	OFF	0: OFF 1: ON	
Auto Zero		4007	R/W	OFF	0: OFF 1: ON		

## 11. CC-Link Settings

Function	Group	Setting name	Command No.	R/W	Default value	Setting value	
System Settings	Setting Memory		5001	R/W	By menu	0: By menu 1: By signal	
			5002	R	Memory 1	0: Memory 1 1: Memory 2 2: Memory 3 3: Memory 4	
	CC-Link	Station Type	5101	R	Ver.1.10, 4 Stations	0: Ver.1.10, 4 Stations 1: Ver.1.10, 2 Stations 2: Ver.1.10, 1 Station	
		Station Number	5102	R	1	1 – 64	
		Transmission Speed	5103	R	10 Mbps	0: 156 kbps 1: 625 kbps 2: 2.5 Mbps 3: 5 Mbps 4: 10 Mbps	
			Return Data Format	5104	R/W	BCD	0: BCD 1: Binary
			Select Memory by	5105	R/W	Manual	0: Manual 1: CC-Link
		Save Setting	5106	R/W	Discard	0: Discard 1: Save	
		Lock	Cal. Value Lock	5201	R/W	OFF	0: OFF 1: ON
	Setting Value Lock		5202	R/W	OFF	0: OFF 1: ON	
	Main unit operation locked		5203	R	OFF	0: OFF 1: ON	
	Key lock		5204	R/W	OFF	0: OFF 1: ON	
	Brightness <sup>1</sup>		5301	R/W	Normal	0: Unlit (becomes unlit after 5 seconds) 1: Dim 2: Standard 3: Bright	
		Power Save Time <sup>1</sup>		5302	R/W	OFF	0: OFF 1: 2 minutes 2: 5 minutes 3: 10 minutes 4: 30 minutes
			Language	5303	R/W	Japanese	0: Japanese 1: English
	Home Screen		5304	R/W	Standard	0: Standard 1: Bar meter 2: Large indicator value	
	TEDS	TEDS Data <sup>2</sup>	Serial number	6001	R		0 – 9999999
			Maximum rated capacity	6002	R		Five digits plus decimal point
			Maximum rated output	6003	R		Five digits plus decimal point (mV/V)
			Bridge Element Impedance	6004	R		Five digits plus decimal point (Ω)
			Max. Exc. Level	6005	R		Five digits (V)
			Calibration Date	6006	R		Year/month/day (yyyy/mm/dd)

<sup>1</sup> If the backlight is off, press one of the buttons on the front of the unit or issue an "execute function" command to relight the backlight.

<sup>2</sup> The calibration date will be BCD and other data will as indicated in "Real-time value/hold value format" on page 85.

### 11-6-4. Error code

Status	Error code	Sub error code	Content
Normal	0	0	No error
Equipment error	1	0	A system error has occurred
Calibration error	2	0	A calibration error has occurred.
		1	The calibration value is locked.
		2	Calibration did not occur.
Measurement error	3	0	-FULL: Display negative overflow (less than minimum display value)
		1	+FULL: Display positive overflow (greater than maximum display value)
		2	-OVER FULL: Exceeding maximum negative input
		3	+OVER FULL: Exceeding maximum input
		4	DA -OVER: DA output exceeds output range in negative direction
	5	DA +OVER: DA output exceeds output range in positive direction	
Command error	4	0	Command execution error (parameter error)
		1	The setting value is locked.
		2	Command No. error

## 12. RS-485 Settings

In this chapter we explain the RS-485 functions of the TD-700T(485)

### 12-1. RS-485 overview

Format: RS-485 two-wire type

Transmission format: start-stop synchronization,  
half-duplex transmission

Number of connected units: 32 maximum  
(including master)

Code: ASCII

#### Precautions and limitations

RS-485 transmission and TEDS transmission share the same terminals. For this reason, RS-485 transmission is not possible when TEDS data is being loaded while the unit is being turned on or due to manual TEDS calibration. (Ordinary TEDS data loading completes about 20 seconds after the unit starts up. Until it completes, any commands issued will be ignored.)

After turning the unit on, wait about 40 seconds as the unit starts up before transmitting.

## 12-2. Connections

### 12-2-1. RS-485 terminals

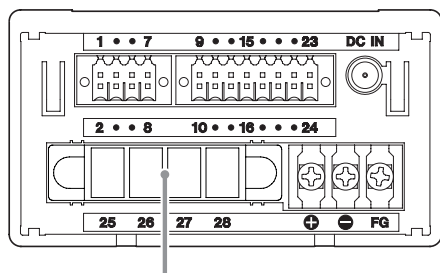

RS-485 terminals

Terminal number	Signal name	Signal
25	A+	Data (not reversed)
26	B-	Data (reversed)
27	TRM	Terminator (by shorting B- and TRM, it can be used as a terminator)
28	FG	Connection line

### 12-2-2. Inserting and removing RS-485 terminal bank

- You can remove the terminal bank from the main unit by loosening the two black screws at the ends of the terminal bank and pulling it out.
- Always disconnect the power before removing or installing a terminal bank.

### 12-2-3. Connecting the RS-485 terminals

- We recommend using twisted-pair cables for connections.
- Pass the connection cable(s) through the included ferrite core before use.
- If these units will be used at both ends, short the B- and TRM terminals. (This will enable termination.)
- Always disconnect the power before working with wiring.
- The recommended torque for the RS-485 terminal screws (M3.5) and attachment screws is 0.69 N·m  $\approx$  7 kgf·cm.
- After wiring, attach the terminal bank cover.

#### CAUTION

For the RS-485 connector, use the included connector. Do not use any other connector because doing so could make it unsafe.

### 12-3. Setting value list

Item	Settings	Format	Default value	Options	Calibration value lock	Setting value lock	Setting value memory
RS-485	Transmission mode	Options	TD Format	TD Format TD Format (BCC) Continuous TX		✓	✓
	ID number	Input	1	1-31		✓	✓
	Baud rate	Options	115200	4800 9600 19200 38400 57600 115200		✓	✓
	Bit length	Options	8 bit	8 bit 7 bit		✓	✓
	Parity	Options	None	None Odd Even		✓	✓
	Stop bit	Options	1 bit	1 bit 2 bit		✓	✓
	Delimiter	Options	CR + LF	CR + LF CR		✓	✓
	Save Setting	Options	Discard	Discard Save		✓	✓

- After changing RS-485 settings, restart the unit.

## 12. RS-485 Settings

### 12-4. Settings

RS-485 setting items are added to the system settings screen for the TD-700T(485).

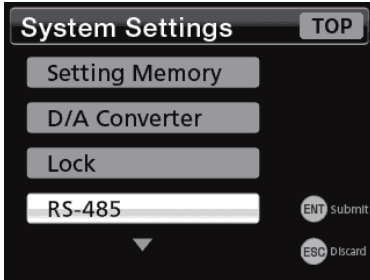

### 12-5. Transmission mode

Select the RS-485 transmission protocol.

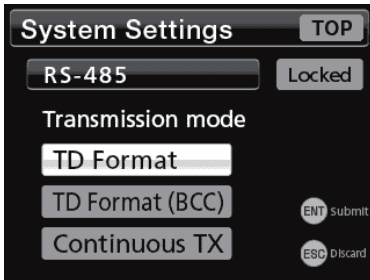

- |                  |  |
|------------------|--|
| TD Format:       | This transmission protocol is unique to the TD-700T.               |
| TD Format (BCC): | This transmission protocol adds check-sum (BCC) to the TD format.  |
| Continuous TX:   | This continuously transmits TD Format polling command (0001) data. |

### 12-6. ID number

This can be set between 1 and 31. Set so it does not overlap with the IDs of other stations.

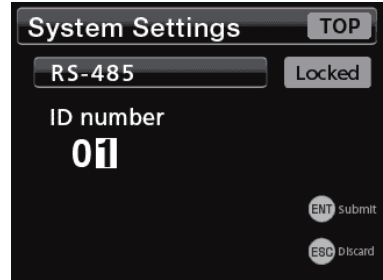

### 12-7. Baud rate

Set the transmission speed for RS-485 communication.

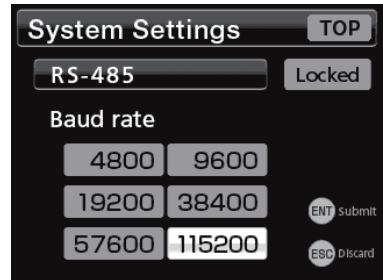

### 12-8. Bit length

Set according to the transmission requirements of connected equipment.

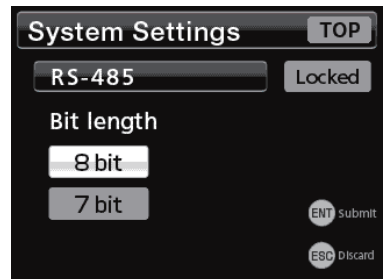

### 12-9. Parity

Set according to the transmission requirements of connected equipment.

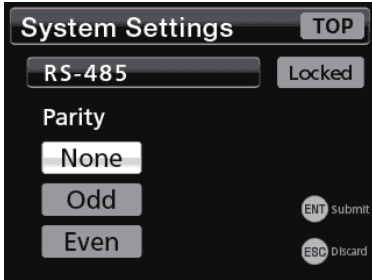

### 12-10. Stop bit

Set according to the transmission requirements of connected equipment.

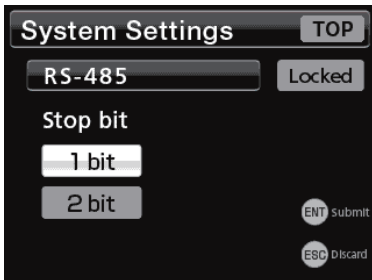

### 12-11. Delimiter

Set according to the transmission requirements of connected equipment.

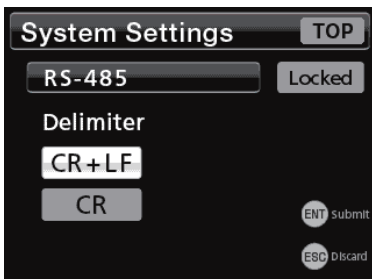

### 12-12. Save Setting

Set whether or not setting values that are changed by external commands, for example, are stored in the internal ROM.

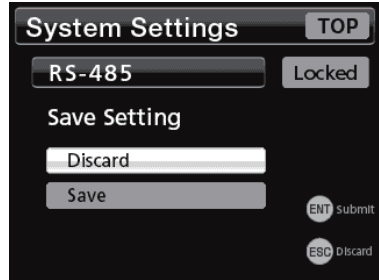

If set to "Discard", the previous settings will be restored when the unit is turned off. (If the Function Menu is opened manually or if the Setting Memory number is changed, this will be stored in the internal ROM.)

When set to "Save", the settings will be retained even when the unit is turned off. However, not only will command response be delayed, changing the settings frequently could result in exceeding the 100,000 write limit of the internal ROM.

## 12. RS-485 Settings

### 12-13. Transmission protocols (TD Format/TD Format (BCC))

TD Format does not use checksums.  
 TD Format (BCC) adds checksums after data.

#### 12-13-1. Commands

##### TD Format

HEX	0x23	0x30	0x31	0x33	0x30	0x30	0x32	0x2D	0x30	0x31	0x38	0x30	0x30	0x0D
ASCII	#	0	1	3	0	0	2	-	0	1	8	0	0	CR

└──────────┘
└──────────────────────────┘
└──┘  
 ID number                      Command No.    Data

##### TD Format (BCC)

HEX	0x23	0x30	0x31	0x33	0x30	0x30	0x32	0x2D	0x30	0x31	0x38	0x30	0x30	0x34	0x43	0x0D
ASCII	#	0	1	3	0	0	2	-	0	1	8	0	0	4	C	CR

└──────────┘
└──────────────────────────┘
└──┘
└──────────┘  
 ID number                      Command No.    Data    Checksum

The first character in the command must always be "#".

The final characters must be "CR".

The data length will be 0–6 characters according to the command.

The checksum (BCC) adds each byte of the ID number, command and data and divides the lower 8 bits into upper and lower parts of 4 bits each and saves them in ASCII as the checksum.

In the example above, the total of the ID number, command and data is as follows.

$$0x30+0x31+0x33+0x30+0x30+0x32+0x2D+0x30+0x31+0x38+0x30+0x30 = 0x24C$$

The checksum is the lower 8 bits, which is 0x4C.



### 12-13-2. Responses

The characters at the beginning of the response show the command execution result. The reply is "ACK" if it was completed properly or "NAK" if it ended in an error.

The characters at the end of the response can be set to either "CR" and "LF" or just "CR" (page 103).

#### Command execution result when completed properly

##### TD Format

HEX	0x06	0x30	0x31	0x33	0x30	0x30	0x32	0x0D	0x0A
ASCII	ACK	0	1	3	0	0	2	CR	LF

##### TD Format (BCC)

HEX	0x06	0x30	0x31	0x33	0x30	0x30	0x32	0x32	0x36	0x0D	0x0A
ASCII	ACK	0	1	3	0	0	2	2	6	CR	LF

When there is response data, it is sent after the command number. The data length will be 0–9 characters according to the command. Checksum calculation is the same as in the "Commands" section above. In the example above, the total of the ID number, command and data is as follows.

$$0x30+0x31+0x33+0x30+0x30+0x32$$

$$= 0x126$$

The checksum is the lower 8 bits, which is 0x26.

#### Command execution result when ended with error

##### TD Format

HEX	0x15	0x30	0x31	0x33	0x30	0x30	0x32	0x0D	0x0A
ASCII	NAK	0	1	3	0	0	2	CR	LF

##### TD Format (BCC)

HEX	0x15	0x30	0x31	0x33	0x30	0x30	0x32	0x32	0x36	0x0D	0x0A
ASCII	NAK	0	1	3	0	0	2	2	6	CR	LF

The following are possible causes of errors.

- Improper command number (unsupported command, etc.)
- Overlapping commands issued
- Improper command parameters (setting values)
- Checksum error occurred (when TD Format (BCC) transmission mode is selected)

## 12. RS-485 Settings

### 12-14. Transmission commands

In this manual, examples of transmission using TD Format (BCC) are given.

To transmit using TD Format, remove the checksum from the transmission examples.

These examples are of transmissions with a device with ID number 1.

Example responses are only given for command execution results that have completed properly.

For response data values that are not fixed, numbers are given as "x" and symbols are given as "±".

- Bit 0 is LSB.

#### 12-14-1. Polling (0001)

##### Command

HEX	0x23	0x30	0x31	0x30	0x30	0x30	0x31	0x32	0x32	0x0D
ASCII	#	0	1	0	0	0	1	2	2	CR

└──────────┘
└──────────┘
└──────────┘  
 ID number      Command No.      Checksum

##### Response

HEX	0x06	0x30	0x31	0x30	0x30	0x30	0x31								0x2E				0x0D	0x0A
ASCII	ACK	0	1	0	0	0	1	ST1	ST2	±	x	x	x	.	x	x	x	x	CR	LF

└──────────┘
└──────────┘
└──────────┘
└──────────┘
└──────────┘  
 ID number      Command No.      Data      Checksum

##### Data

The data is comprised of ST1, ST2 and indicator values.

The code returned for ST1 and ST2 uses ASCII 0x80 and later for bit definition, and the lower 7 bits are assigned to status.

Be aware that the valid statuses for ST1 and ST2 vary as follows depending on the bit length setting.

##### ST1 (8-bit length)

Bit	Name	Status
0	Command status	0: Standing by      1: Executing
1		2: Error occurred      3: Continuous sending mode
2	Nearly zero output	0: OFF      1: ON
3	Hold output	0: OFF      1: ON
4	Zero tracking	0: OFF      1: ON
5	Setting Memory	0: No.1      1: No.2
6		2: No.3      3: No.4
7	Fixed value (1)	

##### ST2 (8-bit length)

Bit	Name	Status
0	Stable output	0: OFF      1: ON
1	OK output	0: OFF      1: ON
2	High limit judgment output	0: OFF      1: ON
3	Low limit judgment output	0: OFF      1: ON
4	Indicator value overflow (±FULL, OVER)	0: OFF      1: ON
5	High high limit judgment output	0: OFF      1: ON
6	Low low limit judgment output	0: OFF      1: ON
7	Fixed value (1)	

### ST1 (7-bit length)

Bit	Name	Status
0	Command status	0: Standing by    1: Executing
1		2: Error occurred    3: Continuous sending mode
2	Nearly zero output	0: OFF    1: ON
3	Hold output	0: OFF    1: ON
4	Zero tracking	0: OFF    1: ON
5	Fixed value (1)	
6	Fixed value (1)	
7	don't care	

### ST2 (7-bit length)

Bit	Name	Status
0	Stable output	0: OFF    1: ON
1	OK output	0: OFF    1: ON
2	High limit judgment output	0: OFF    1: ON
3	Low limit judgment output	0: OFF    1: ON
4	Indicator value overflow (±FULL, OVER)	0: OFF    1: ON
5	Fixed value (1)	0: OFF    1: ON
6	Fixed value (1)	0: OFF    1: ON
7	don't care	

## 12-14-2. Status polling (0002)

This only returns polling (0001) status data.

### Command

HEX	0x23	0x30	0x31	0x30	0x30	0x30	0x32	0x32	0x33	0x0D
ASCII	#	0	1	0	0	0	2	2	3	CR

⏟
⏟
⏟  
 ID number      Command No.      Checksum

### Response

HEX	0x06	0x30	0x31	0x30	0x30	0x30	0x32				0x0D	0x0A
ASCII	ACK	0	1	0	0	0	2	ST1	ST2	x	x	CR LF

⏟
⏟
⏟
⏟  
 ID number      Command No.      Data      Checksum

### Data

The data is comprised of ST1 and ST2.

The contents of ST1 and ST2 are the same as polling (0001).

## 12. RS-485 Settings

### 12-14-3. Indicator value polling (0003)

This only returns polling (0001) indicator values.

#### Command

HEX	0x23	0x30	0x31	0x30	0x30	0x30	0x32	0x32	0x34	0x0D
ASCII	#	0	1	0	0	0	3	2	4	CR

ID number
Command No.
Checksum

#### Response

HEX	0x06	0x30	0x31					0x2E				0x0D	0x0A
ASCII	ACK	0	1	±	x	x	x	.	x	x	x	CR	LF

ID number
Data
Checksum

### 12-14-4. Setting value writing/execution command format

This uses the same commands as CC-Link. Command numbers 0000–5304 in “11-6-3. Command” on page 94 are transmitted in this format.

Data is fixed to 6 characters. If the data lacks 6 characters, each opening will be filled with a “0”.

- Responses will be returned before execution commands complete operation. (Immediate completion)
- Always use a polling command (0001) or polling status (0002) to confirm that the ST1 command status is standby before issuing the next command.
- Parameters set in the command data should be aligned to the right.

#### Command

Hold mode setting (4001) example

HEX	0x23	0x30	0x31	0x34	0x30	0x30	0x31	0x30	0x30	0x30	0x30	0x30			0x0D	
ASCII	#	0	1	4	0	0	1	0	0	0	0	0	x	x	x	CR

ID number
Command No.
6 data characters, aligned to the right
Checksum

#### Response

Hold mode setting (4001) example

HEX	0x06	0x30	0x31	0x34	0x30	0x30	0x31	0x45	0x30	0x0D	0x0A
ASCII	ACK	0	1	4	0	0	1	E	0	CR	LF

ID number
Command No.
Checksum

### 12-14-5. Setting value loading command format

This uses the same commands as CC-Link. Command numbers 0000–5304 in “11-6-3. Command” on page 94 are transmitted in this format.

Data is fixed to 6 characters. If the data lacks 6 characters, each opening will be filled with a “0”.

#### Command

Hold mode setting (4001) example

HEX	0x23	0x30	0x31	0x34	0x30	0x30	0x31	0x45	0x30	0x0D
ASCII	#	0	1	4	0	0	1	E	0	CR

⏟
⏟
⏟  
 ID number      Command No.      Checksum

#### Response

Hold mode setting (4001) example

HEX	0x06	0x30	0x31	0x34	0x30	0x30	0x31	0x30	0x30	0x30	0x30	0x30	0x30	0x0D	0x0A			
ASCII	ACK	0	1	4	0	0	1	0	0	0	0	0	0	x	x	x	CR	LF

⏟
⏟
⏟
⏟  
 ID number      Command No.      6 data characters      Checksum

### 12-14-6. TEDS command format

Command numbers 6001–6006 in “11-6-3. Command” on page 94 are transmitted in this format.

Data is fixed to 8 characters. If the data lacks 8 characters, each opening will be filled with a “0”.

#### Command

Example of TEDS maximum rated capacity (6002)

HEX	0x23	0x30	0x31	0x36	0x30	0x30	0x32	0x32	0x39	0x0D
ASCII	#	0	1	6	0	0	2	2	9	CR

⏟
⏟
⏟  
 ID number      Command No.      Checksum

#### Response

Example of TEDS maximum rated capacity (6002)

HEX	0x06	0x30	0x31	0x36	0x30	0x30	0x32	0x32	0x30	0x30	0x32	0x30	0x30	0x30	0x41	0x44	0x0D	0x0A
ASCII	ACK	0	1	6	0	0	2	2	0	0	2	0	0	0	A	D	CR	LF

⏟
⏟
⏟
⏟  
 ID number      Command No.      8 data characters      Checksum

The decimal point position is 2, so the rated capacity is 200.00.

See “Real-time value/hold value format” on page 85 for details about the data format for TEDS maximum rated capacity (6002).

## 12. RS-485 Settings

### 12-14-7. Continuous transmission format

In "12-5. Transmission mode" on page 102, select "Continuous TX" and exit the menu screen to continuously send polling (0001) response data. No checksum is added during continuous transmission.

HEX	0x06	0x30	0x31	0x30	0x30	0x30	0x31							0x2E			0x0D	0x0A
ASCII	ACK	0	1	0	0	0	1	ST1	ST2	±	x	x	x	.	x	x	CR	LF

ID number
Command No.
Data

See "12-14-1. Polling (0001)" on page 106 for details about the data format.

### Timing

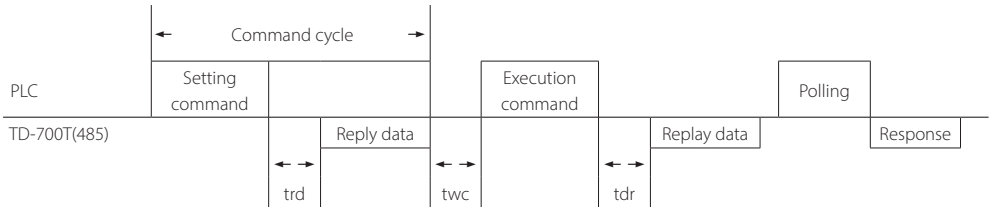

tdr: 15ms typical command response  
twc: 30ms minimum command interval

- Always leave at least 30 ms open between command cycles.
- After issuing a calibration command, leave an interval of at least 60 (ms) before issuing the next command.

#### ATTENTION

- When using a high-speed sampling mode, make twc be at least 50 ms.
- When conducting zero balancing using a command, we recommend using a Zero Balancing command (1004) instead of an Execute command (0000).  
When using an Execute command to conduct zero balancing, leave at least 1 second after it before issuing the next command.

## 13. Error message list

Message	Explanation
LOAD	A/D converter positive overflow
-LOAD	A/D converter negative overflow
FULL	Display positive overflow (greater than maximum display value)
-FULL	Display negative overflow (less than minimum display value)
OVER FULL	Input is exceeding maximum input (3.2 mV/V)
-OVER FULL	Input is exceeding maximum negative input (-3.2 mV/V)
ZERO OVER	Zero balancing range exceeds regulated values
ZERO ERROR	Zero-adjusting failed within specified time
OUTPUT CAL OVER	Sensor output exceeds calibration range
OUTPUT CAL SHORT	Sensor output does not achieve calibration range
MINUS INPUT	Sensor input is negative
TEDS READ ERROR	A valid TEDS sensor is not connected
TEDS LOADING ERROR	Even though TEDS has been disabled by the "Remote Sense/TEDS" setting, TEDS memory was accessed.
TEDS PW ERROR	Input password different from the one set
PARAMETER ERROR	Irregular setting value exists
R.O. SET OVER	Rated output exceeds the set range (greater than 3.2 mV/V)
R.O. SET SHORT	Rated output below the set range (less than 0.3 mV/V)
ZERO LIMIT OVER	Digital Zero Limit exceeded
ERROR	An error has occurred
DA OVER	DA output is outside output range
DA -OVER	DA output is outside output range
SYSTEM ERROR	A system error has occurred
INVALID OPERATION	Operation is invalid

Fast Sampling Mode	Result will be shown after hold stops
Zero Balancing	Please wait a while
Executing Digital Zero	Please wait a while
Reading TEDS data	Please wait a while
Writing TEDS data	Please wait a while

## 14. Warranty explanation

---

- The warranty period for this device is one year from the date of purchase.
- Be aware that repairs will require payment in the following cases even during the warranty period.
  - 1) Malfunction or damage due to misuse
  - 2) Malfunction or damage caused by modifications or repairs conducted by any party other than our or a service person designated by our company
  - 3) Malfunction or damage caused by dropping, transportation or similar handling after product delivery
  - 4) Malfunction or damage caused by fire, earthquake, water, lightning or other natural disaster
  - 5) Malfunction or damage caused by external factors, including power supplies and equipment environmental conditions, that deviate from the operation requirements of this product
  - 6) Malfunction or damage if the product was not purchased from our company or an agent designated by our company
- We offer paid service after the conclusion of the warranty period. For details, please contact the retailer where you purchased the unit or a contact on the back cover of this manual.
- Be aware that our company will bear no responsibility for any secondary damages resulting from the operation of this device or related to data.
- Be aware that our company will bear no responsibility if data recorded by this device is deleted as a result of misoperation or unexpected incident, for example.
- Information is given about products in this manual only for the purpose of example and does not indicate any guarantees against infringements of third-party intellectual property rights and other rights related to them. TEAC Corporation will bear no responsibility for infringements on third-party intellectual property rights or their occurrence because of the use of these products.



# 15. Specifications

Bridge Voltage		DC, 2.5/10 V, $\pm 10\%$ (30mA current maximum, can be used with remote sense)
Signal input range		$\pm 3.2$ mV/V
Equivalent input/TEDS	Calibration range	0.3 mV/V – 3.2 mV/V
	Calibration precision	Within 0.1% F.S. (when using a 1m standard TEAC $\Phi 8$ , 4-core shielded cable with 350 $\Omega$ impedance, 10V BV and 0.5mV/V or greater setting)
Precision	Linearity	Within 0.01% F.S. + 1 digit (when input is 1 mV/V or greater)
	Zero drift	Within 0.5 $\mu\text{V}/^\circ\text{C}$ (input conversion value)
	Gain drift	Within $\pm 0.005\%$ F.S./ $^\circ\text{C}$
A/D conversion		24-bit, 4000 times per second, 20000 times per second (fast sampling mode)
Low-pass filter		Select 3 Hz ( $-6$ dB/oct), 10, 30, 100, 300, 1000 Hz ( $-12$ dB/oct) or none
D/A output		4000 times per second, isolated output, $\pm 1$ – $\pm 10$ V voltage output (set in 1V steps) and about 1/59000 resolution (when set to $\pm 10$ V), or 4–20mA current output and about 1/43000 resolution
TEDS function		IEEE1451.4 class 2 mix mode interface
Display		320 x 240 color liquid crystal
Indicator value	Display range	–99999 – 99999
	Decimal point	Display position selectable
	Times displayed	Select 4, 6, 10 or 20 times/second
Displayed items	Calibration settings	Zero calibration/span calibration (TEDS calibration, actual load calibration, equivalent input calibration)
	Function settings	High limit, low limit, high high limit, low low limit, comparison mode, hysteresis, nearly zero, moving average, low pass filter, motion detect, zero tracking, static strain, digital zero, digital zero offset, zone definition, hold mode, key lock, minimum grid, display times, bridge voltage, digital zero limit, clear digital zero, comp. output pattern, comparison output control, select data output, D/A converter, remote sense
Hold functions		Sample hold, peak hold, bottom hold, peak to peak hold, peak and bottom hold, average hold, zone definition hold (peak, bottom, peak to peak, peak and bottom, average)
External input and output signals	Input	Hold, judge, clear, digital zero, setting memory selection 1, setting memory selection 2 (isolated from main unit circuits using a photocoupler)
	Output	HH, HI, OK, LO, LL open collector output (isolated from main unit circuits using a photocoupler)
	CC-Link*	DA, DB, DG (these three are all isolated from main unit circuits), SLD
	RS-485**	A+, B– (isolated from main unit circuits using a photocoupler), TRM, FG
Power supply	AC adapter specifications	Output ratings: DC 12 V, 0.8 A Input ratings: AC 100 V – 240 V, 50/60 Hz, 0.5 A NOTE: An AC adapter is included with the TD-700T for Japan and North America. No adapter is included for other regions. (The included AC adapter conforms to the safety standards of Japan and North America.)
	DC power supply specifications	Ratings: DC 12–24 V, 9 W
Operating temperature range		0 $^\circ\text{C}$ – 40 $^\circ\text{C}$
Storage temperature range		–20 $^\circ\text{C}$ – 60 $^\circ\text{C}$
Operating humidity range		85% RH or less (without condensation)
Applicable standards		CE marking EN61326 (class A), UL61010-1, FCC (Class A), UKCA marking
External dimensions (W x H x D)		Approximately 96 mm x 53 mm x 132 mm (without protrusions)
Weight		About 300 g

\*Only with CC-Link option.

\*\*Only with RS-485 option.

- Specifications and appearance are subject to change without notice.
- Weight and dimensions are approximate.
- Illustrations in this document might differ slightly from production models.



TD-700T (CCL)

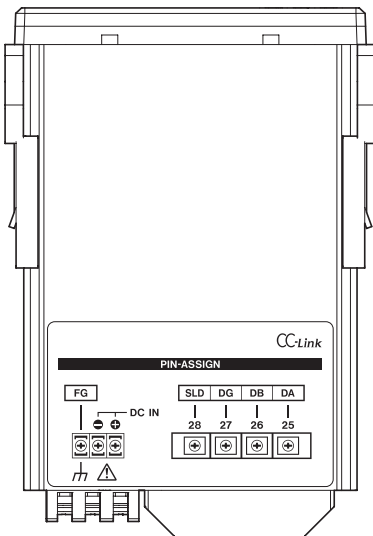
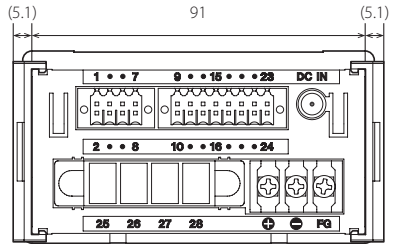
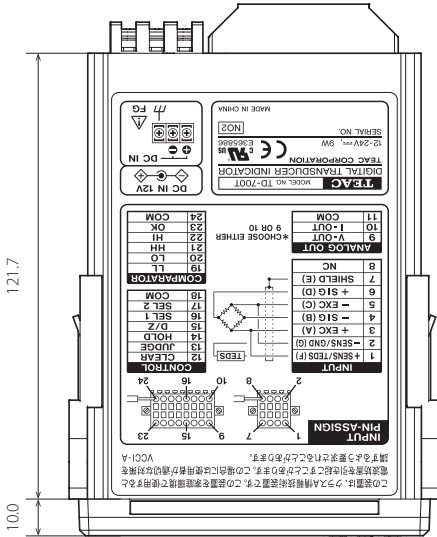



# 17. Block diagram

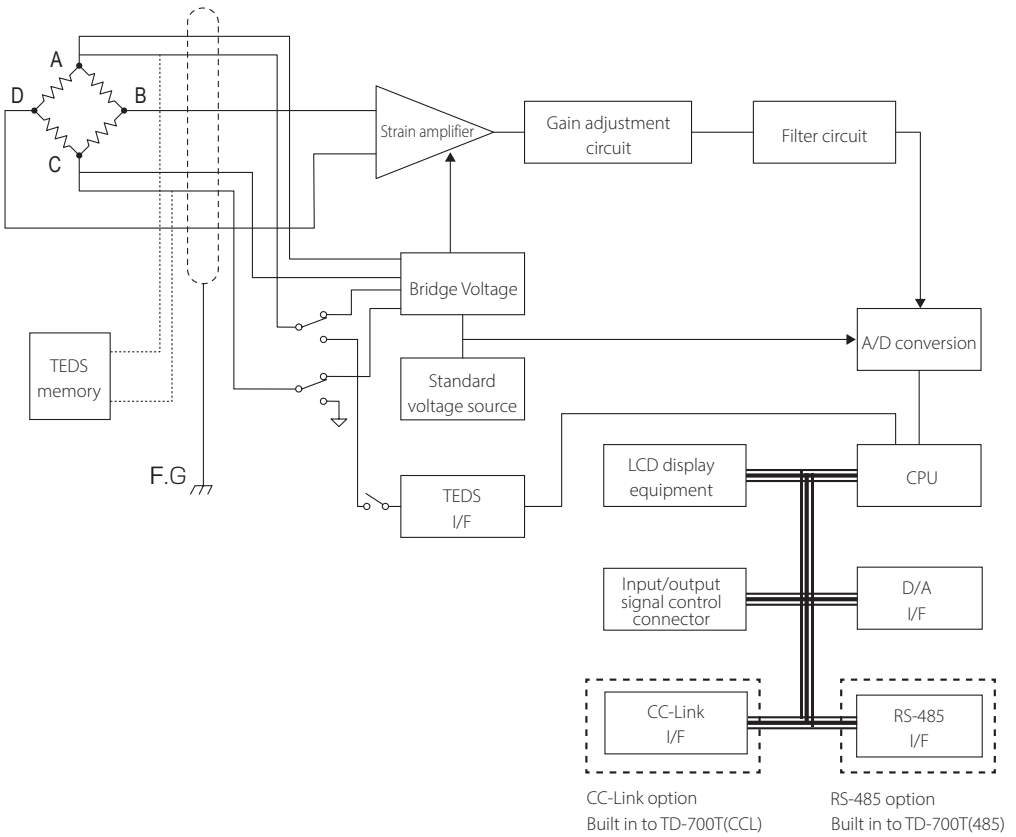





# TEAC

---

TEAC CORPORATION	1-47 Ochiai, Tama-shi, Tokyo 206-8530, Japan	Phone: +81-42-356-9154
TEAC AMERICA, INC.	10410 Pioneer Blvd. Unit #1, Santa Fe Springs, California 90670, U.S.A.	Phone: +1-323-726-0303
TEAC EUROPE GmbH. (EU Importer)	Bahnstrasse 12, 65205 Wiesbaden-Erbenheim, Germany	Phone: +49-(0)611-7158-349
TEAC UK Limited (UK Importer)	Luminous House, 300 South Row, Milton Keynes, Buckinghamshire, MK9 2FR, UK	Phone: +44-1923-797205
TEAC SALES & TRADING (ShenZhen) CO., LTD.	Room 817, Xinian Center A, Tairan Nine Road West, Shennan Road, Futian District, Shenzhen, Guangdong Province 518040, China	Phone: +86-755-88311561-2

---