

# TEAC

## Portable Indicator Instructions for Use

# TD-01 Portable

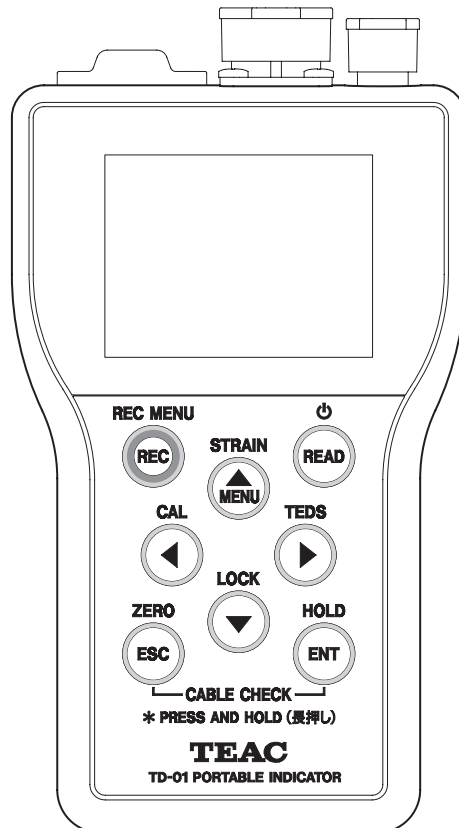

# Introduction

Thank you for purchasing the TD-01 Portable Indicator. Please read this document in its entirety before using the product to get the best performance and ensure safe and proper operation.

## Features

- Five-digit digital display enables direct reading of physical quantities up to  $\pm 99999$ .
- Support for TEDS sensors makes calibration easy. Automatic calibration is also possible when a TEDS sensor is connected.
- An equivalent input function is included, making sensitivity adjustment without actual loads easy.
- Static strain measurement is possible. Identifying load cell defects and other problems through plastic deformity is easy.
- Supports high and low limit comparison functions
- Supports a variety of functions, including peak hold, bottom hold and holds with zone designations.
- D/A output according to designated values is a standard feature.
- Product is RoHS compliant
- Waveform display function allows input signals to be checked as waveforms.
- Interrupted wire checking function built-in
- 300 indicator values and 8 graphs can be saved in the internal memory
- Product help function  
As a help function, this unit shows on-screen QR codes that link to operation manual pages on our website. Please be aware, however, that some portable devices might not be able to read the QR codes correctly.

## Disclaimers

Information is given about products in this manual only for the purpose of example and does not indicate any guarantees against infringements of third-party intellectual property rights and other rights related to them. TEAC Corporation will bear no responsibility for infringements on third-party intellectual property rights or their occurrence because of the use of these products.

## Included accessories

If anything is missing or damaged, contact us. (For contact information, see the last page.)

CR2032 button cell battery (preinstalled in unit)	1
AA batteries	4
Micro USB cable	1
Instructions for Use (this document)	1

Company names and product names in this document are the trademarks or registered trademarks of their respective owners.

# Safety information

This document describes the safety instructions for the operation of the digital indicator. Before operating the product, read this document carefully to familiarize yourself with the unit.

 <b>WARNING</b>	<b>Follow the instructions below to avoid risk of serious personal injury and death.</b>
	Never use beyond the rated specifications as there is the danger of property damage, injury, fire or electrical shock.
	Never use in flammable gaseous environments including the following locations as there is the danger of explosion. Locations containing corrosive or flammable gases Locations near water, oil or subject to chemical splash
	If this product malfunctions (smells strange or becomes hot), stop using it immediately, unplug the USB cable and remove the batteries as there is danger of fire or electrical shock.
	Never attempt to disassemble the product.
	Carefully check connections and wiring before applying power.
	Do not allow foreign objects such as metal fragments that result from cutting panels, wires or other materials to enter this unit.
	If the unit is dropped or subject to strong impacts, it could break. If this occurs, stop using it and contact the seller from which you purchased it.
	If the unit is used in a manner not specified by the manufacturer, the protection provided by the unit may be impaired.

## **Precautions concerning batteries**

Misuse of batteries could cause them to rupture or leak leading to fire, injury or the staining of nearby things. Please read and observe the following precautions carefully.

- Be sure to insert the batteries with correct positive (⊕) and negative (⊖) orientations.
- Use batteries of the same type. Never use different types of batteries together.
- If the remote control is not used for a long time (more than a month), remove the batteries to prevent them from leaking.
- If the batteries leak, wipe away the leakage inside the battery compartment and replace the batteries with new ones.
- Do not use batteries of types other than those specified. Do not mix new batteries with old ones or use different types of batteries together.
- Do not heat or disassemble batteries. Never throw batteries into fire or water.
- Do not carry or store batteries with other metallic objects. The batteries could short circuit, leak or explode.
- Never recharge a battery unless it is confirmed to be a rechargeable type.

## **WARNING**

### **DO NOT INGEST BATTERY, CHEMICAL BURN HAZARD**

- This product contains a coin/ button cell battery. If the coin/button cell battery is swallowed, it can cause severe internal burns in just 2 hours and can lead to death.
- Keep new and used batteries away from children.
- If the battery compartment does not close securely, stop using the product and keep it away from children.
- If you think batteries might have been swallowed or placed inside any part of the body, seek immediate medical attention.

# Safety information

 <b>CAUTION</b> Follow the instructions below to avoid risk of personal injury or property damage.
Put the unit power into standby before doing any of the following. <ul style="list-style-type: none"><li>● Installing load cells</li><li>● Replacing batteries</li><li>● Connecting other external equipment</li></ul>
Never touch the connectors while the product is turned on.
When connecting to a power supply or signal input/output connector, be sure to wire them correctly after confirming the signal names and pin assignment numbers. Use shielded cables for signal input/output cables (load cell, external input/output). Conduct wiring in a place so that it will not be together or parallel with electrical wiring.
Avoid use in locations like the following. <ul style="list-style-type: none"><li>● Near a power line</li><li>● Where a strong electric or magnetic field is present</li><li>● Where static electricity or noise, (for example, from a relay) is generated</li></ul>
Do not install in the following environments. <ul style="list-style-type: none"><li>● Locations subject to temperatures exceeding the specified temperature and humidity ranges</li><li>● Locations subject to radiant heat from heat sources</li><li>● Locations with high salt or iron content</li><li>● Locations exposed to dirt and dust</li><li>● Locations subject to direct vibration or shock</li><li>● Locations subject to severe temperature changes</li><li>● Outdoor, or locations with an altitude of higher than 2000 m</li><li>● Locations where freezing or condensation might occur</li></ul>
Do not operate a damaged unit.
If the front panel is dirty, wipe it with a soft cloth lightly dampened with a solution of a neutral detergent and water. Then wipe it again with a slightly damp cloth. DO NOT use a chemically treated dust cloth, paint thinner, or other flammable solvents. Using any of them could damage the coating of the product.
If the product is used in a manner unintended by the manufacturer, the user's safety may be adversely affected.
Always attach the back cover when an electric current is present.
If subject to electromagnetic waves (from transceivers, mobile phones, amateur wireless transmissions, etc.), use metal pipes for the wiring or make other countermeasures using shielding.

## WARNING

This is a Class A product. In a domestic environment, this product may cause radio interference in which case the user may be required to take adequate measures.

## ATENCIÓN

Este es un producto de clase A. En un entorno no profesional, este aparato puede producir interferencias de radio, en cuyo caso el usuario será el responsable de tomar las medidas necesarias para solucionarlo.

## AVERTISSEMENT

Il s'agit d'un produit de Classe A. Dans un environnement domestique, cet appareil peut provoquer des interférences radio, dans ce cas l'utilisateur peut être amené à prendre des mesures appropriées.

## Warnung

Dies ist eine Einrichtung, welche die Funk-Entstörung nach Klasse A besitzt. Diese Einrichtung kann im Wohnbereich Funkstörungen verursachen ; in diesem Fall kann vom Betreiber verlangt werden, angemessene Maßnahmen durchzuführen und dafür aufzukommen.

## Model for USA

### Declaration of Conformity

Model number: TD-01 Portable

Trade name: TEAC

Responsible party: TEAC AMERICA, INC.

Address: 10410 Pioneer Blvd. Unit #1, Santa Fe Springs, California 90670, U.S.A.

Telephone number: 1-323-726-0303

This device complies with Part 15 of the FCC Rules. Operation is subject to the following two conditions: (1) this device may not cause harmful interference, and (2) this device must accept any interference received, including interference that may cause undesired operation.



### Information

This equipment has been tested and found to comply with the limits for a Class A digital device, pursuant to part 15 of the FCC Rules. These limits are designed to provide reasonable protection against harmful interference when the equipment is operated in a commercial environment. This equipment generates, uses, and can radiate radio frequency energy and, if not installed and used in accordance with the instruction manual, may cause harmful interference to radio communications. Operation of this equipment in a residential area is likely to cause harmful interference in which case the user will be required to correct the interference at his own expense.

### CAUTION

Changes or modifications not expressly approved by the party responsible for compliance could void the user's authority to operate the equipment.

## Model for Canada

Industry Canada's Compliance Statement:

This Class A digital apparatus complies with Canadian ICES-003.

CET APPAREIL NUMÉRIQUE DE LA CLASSE A EST CONFORME À LA NORME NMB-003 DU CANADA

## Model for Europe



This product complies with the European Directives request, and the other Commission Regulations.

## Model for UK

This product complies with the applicable UK regulations.



## For European Customers

### Disposal of electrical and electronic equipment and batteries and/or accumulators

- All electrical/electronic equipment and waste batteries/accumulators should be disposed of separately from the municipal waste stream via collection facilities designated by the government or local authorities.
- By disposing of electrical/electronic equipment and waste batteries/accumulators correctly, you will help save valuable resources and prevent any potential negative effects on human health and the environment.
- Improper disposal of waste electrical/electronic equipment and batteries/accumulators can have serious effects on the environment and human health because of the presence of hazardous substances in the equipment.
- The Waste Electrical and Electronic Equipment (WEEE) symbols, which show wheeled bins that have been crossed out, indicate that electrical/electronic equipment and batteries/accumulators must be collected and disposed of separately from household waste. If a battery or accumulator contains more than the specified values of lead (Pb), mercury (Hg), and/or cadmium (Cd) as defined in the Battery Directive (2006/66/EC, 2013/56/EU), then the chemical symbols for those elements will be indicated beneath the WEEE symbol.
- Return and collection systems are available to end users. For more detailed information about the disposal of old electrical/electronic equipment and waste batteries/accumulators, please contact your city office, waste disposal service or the shop where you purchased the equipment.



**Pb, Hg, Cd**

# Contents

Introduction .....	2	4-9. Setting menu list .....	27
Features .....	2	4-9-1. Function Menu .....	27
Included accessories .....	2	4-9-2. Calibration .....	27
Safety information .....	3	4-9-3. Condition Setting .....	28
Installing batteries .....	8	4-9-4. Comparison Setting .....	28
AA batteries .....	8	4-9-5. Hold Function Setting .....	28
Replacing batteries .....	8	4-9-6. Graph settings .....	28
Button cell battery .....	8	4-9-7. System settings 1 .....	28
Removing the button cell battery .....	8	4-9-8. System settings 2 .....	28
Installing a button cell battery .....	8	4-9-9. TEDS Settings .....	28
Turning the unit on/off .....	9	4-10. Setting value list .....	29
Turning the power on .....	9	4-10-1. Calibration .....	29
Putting the unit into standby .....	9	4-10-2. Condition Setting .....	30
1. Names and functions of parts .....	10	4-10-3. Comparison Setting .....	30
1-1. Front panel .....	10	4-10-4. Hold Function Setting .....	30
1-2. Top panel .....	11	4-10-5. Graph settings .....	31
1-3. Sensor signal input terminals .....	12	4-10-6. System settings 1 .....	31
1-4. Bottom panel .....	12	4-10-7. System settings 2 .....	32
1-5. Screen transition diagram .....	13	4-10-8. TEDS Settings .....	32
1-6. Home Screen .....	14	5. Calibration .....	33
1-6-1. Indicator value screen .....	14	5-1. Procedures shared by all calibration methods .....	34
1-6-2. Graph screen .....	15	5-1-1. Locking and unlocking calibration values .....	34
1-6-2-1. Snapshot .....	16	5-2. Equivalent input calibration .....	35
1-6-3. Bar meter screen .....	16	5-2-1. Sensor value memory .....	35
Hold display overview .....	17	5-2-2. Rated Output .....	36
1-7. Static Strain Disp. Mode .....	17	5-2-3. Rated Capacity .....	36
1-8. Simple indication .....	17	5-2-4. Zero Balancing .....	36
2. Shortcut menus .....	18	5-2-5. Select EU .....	36
2-1. Memory and list selection/display .....	18	5-2-6. Cal. Value Lock .....	36
2-1-1. Sensor value memory .....	18	5-3. Actual Load Calibration .....	36
2-1-2. Setting Memory .....	18	5-3-1. Sensor value memory .....	36
2-1-3. Indicator value list .....	18	5-3-2. Zero Balancing .....	37
2-1-4. Graph list .....	19	5-3-3. Rated capacity (load calibration) .....	37
2-2. Indicator recording mode .....	21	5-3-4. Select EU .....	38
2-2-1. Indicator recording mode .....	21	5-3-5. Max. Disp. Value .....	38
2-2-2. Overwrite oldest first .....	21	5-3-6. Cal. Value Lock .....	38
2-2-3. Showing the list of recorded indicator values .....	21	5-4. TEDS calibration .....	38
2-3. Recording graph data .....	21	5-4-1. Rated Output/Rated Capacity display .....	39
3. Making connections .....	22	5-4-2. Zero Balancing .....	39
3-1. Connecting with the terminal bank .....	22	5-4-3. Select EU .....	39
3-2. Connecting a strain gauge transducer .....	22	5-4-4. Cal. Value Lock .....	39
3-2-1. Notes about bridge voltage (applied voltage) .....	22	5-5. Sensor value memory .....	39
3-3. Interrupted wire checking .....	23	5-6. Select Min. Grid .....	40
4. Settings .....	24	5-7. Max. Disp. Value .....	40
4-1. Basic operation .....	24	5-8. Select EU .....	40
4-2. Selecting setting values from options .....	25	5-9. Sensor input logic .....	41
4-3. Inputting numerical setting values .....	25	5-10. Zero Balancing .....	41
4-4. Changing the decimal point position .....	26	5-11. Digital Zero .....	41
4-5. Lock .....	26		
4-6. Returning to the Home Screen .....	27		
4-7. Viewing the version .....	27		
4-8. Initializing all settings .....	27		

6. Condition Settings.....	42	11. System settings 2.....	61
6-1. Filter.....	42	11-1. Device number.....	61
6-1-1. Select Num. of Moving Avg.....	42	11-2. Date & time setting.....	61
6-1-2. Auto Digital Filter.....	42	11-2-1. Date display format.....	61
6-2. Motion Detect.....	43	11-2-2. Date & time setting.....	62
6-2-1. Time.....	43	11-3. Battery type.....	62
6-2-2. Width.....	43	11-4. Indicator recording mode.....	62
6-3. Zero Tracking.....	44	11-5. Recorded data deletion.....	62
6-3-1. Time.....	44	12. TEDS Settings.....	63
6-3-2. Width.....	44	12-1. TEDS Data.....	63
6-4. Digital Zero Offset.....	45	12-2. TEDS Data Change.....	64
6-5. Digital Zero.....	45	12-3. Restore TEDS Data.....	65
6-5-1. Enable Digital Zero.....	45	13. Error message list.....	66
6-5-2. Digital Zero Limit Value.....	45	14. Warranty explanation.....	67
6-5-3. Clear Digital Zero.....	45	15. Specifications.....	68
6-6. Select Data Output.....	46	16. External drawings.....	69
7. Comparison Setting.....	47	17. Block diagram.....	70
7-1. Comp. Value Setting.....	47		
7-2. Comp. Mode Setting.....	47		
7-3. Hysteresis.....	48		
7-4. Nearly Zero.....	49		
8. Hold Function Setting.....	50		
8-1. Hold Mode.....	50		
8-1-1. Sample and hold.....	51		
8-1-2. Peak hold.....	51		
8-1-2-1. No zone definition.....	51		
8-1-2-2. Zone definition used.....	52		
8-1-3. Bottom hold.....	52		
8-1-3-1. No zone definition.....	52		
8-1-3-2. Zone definition used.....	53		
8-2. Zone Definition.....	54		
8-3. Auto Zero.....	54		
9. Graph settings.....	55		
9-1. Time axis setting (X).....	55		
9-2. Indicator value axis setting (Y).....	55		
9-3. Trigger mode.....	55		
9-4. Trigger.....	55		
9-4-1. Trigger polarity.....	55		
9-4-2. Trigger level.....	56		
9-4-3. Trigger position.....	56		
10. System settings 1.....	57		
10-1. Setting Memory.....	57		
10-2. D/A Converter.....	57		
10-2-1. D/A output.....	57		
10-2-2. D/A Zero.....	57		
10-2-3. D/A Full Scale.....	58		
10-2-4. D/A Max. Voltage.....	58		
10-2-5. D/A CAL TEST.....	59		
10-3. Lock.....	59		
10-3-1. Cal. Value Lock.....	59		
10-3-2. Setting value lock.....	59		
10-4. Brightness.....	59		
10-4-1. Brightness.....	59		
10-4-2. Backlight dimmer.....	60		
10-5. Auto power off.....	60		
10-6. Languages.....	60		
10-7. Reset to the Factory Settings.....	61		

# Installing batteries

Remove the back cover and insert the batteries.  
Close the cover after inserting the batteries

 **Misuse of batteries could cause them to rupture or leak, which might result in fire, injury or the staining of nearby materials. Please read and observe the precautions on page 3 carefully.**

## AA batteries

Insert four AA batteries with their +/- oriented as shown in the case.

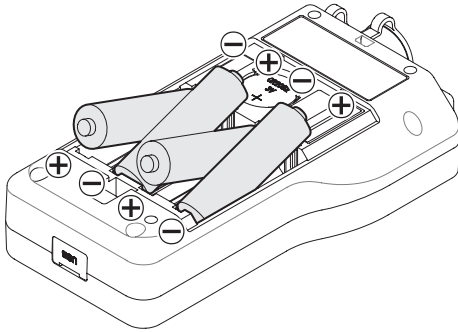

## Replacing batteries

When replacing the AA batteries, replace all 4 of them with new ones.  
Dispose of the used batteries according to the instructions on them or requirements set by your local municipality.

- Continuous operation time on battery power is approximately 24 hours (when the sensor load is 350  $\Omega$  and EVOLTA alkaline batteries are used).
- Set the battery type using the "Battery type" item of "System settings 2" (page 62).

## Button cell battery

The button cell battery is used to back up the clock.

Replace the button cell battery if the clock display shows that it is January 1, 2000 after the power is turned on, except for the first time you start the unit after purchase.

- When the unit is shipped new, a button cell battery is already installed to allow you to check operation of the unit. This battery is provided for checking operation and might not last very long.

## Removing the button cell battery

Insert a fine-tipped rod into the right side of the button cell battery holder to unlock the battery.

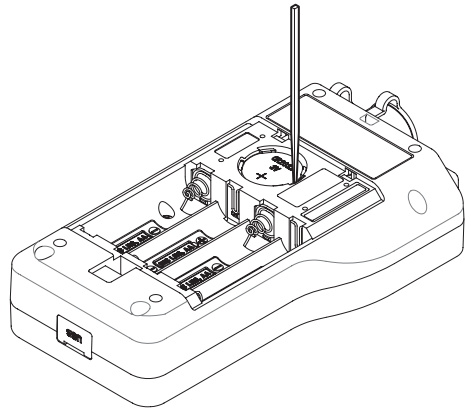

## Installing a button cell battery

Insert the button cell battery into the left side of the button cell battery holder, and press the right side of the battery.

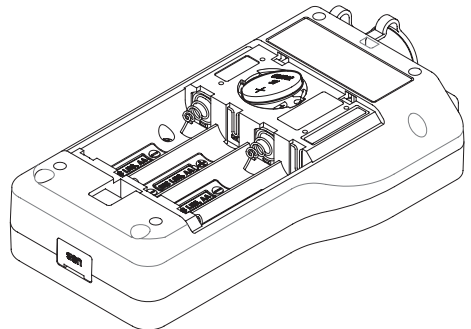



# Turning the unit on/off

## Turning the power on

When the unit is in standby, press the READ/⏻ button until the backlight lights.

After the unit starts and "Starting up..." appears on the display, the Home Screen opens (page 14)

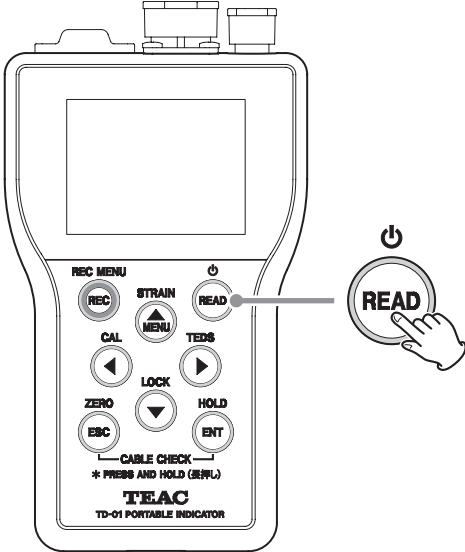

## Putting the unit into standby

When the unit is on, press the READ/⏻ button until "Shutting down..." is shown.

After shutdown procedures complete, the unit will be in standby mode.

### ATTENTION

When the unit is using bus power, do not disconnect the USB cable or turn the bus power off during shutdown procedures. This could cause saved setting values to be erased.

# 1. Names and functions of parts

## 1-1. Front panel

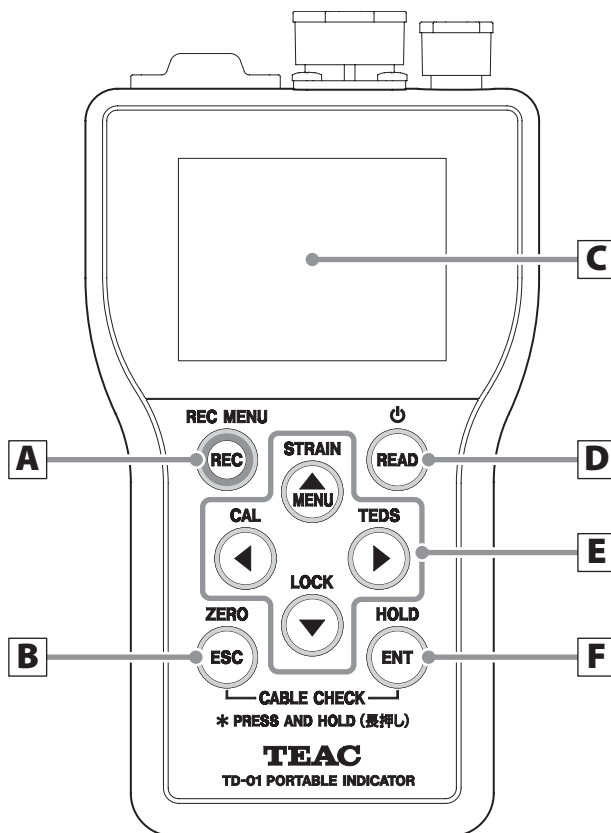

### A REC/REC MENU button

#### REC

When the indicator recording mode is set to “When REC key pressed”, the indicator value is recorded each time this button is pressed (page 21).

#### REC MENU

Press and hold this to open the indicator recording mode screen (page 21).

### B ESC/ZERO button

When holding, this button clears the hold value. Press when a setting screen is open to move up one level.

When Cal. Value Lock is OFF, press and hold to use the Zero Balancing function (page 41).

When Cal. Value Lock is ON, press this to forcibly set the indicator value to zero (Digital zero function).

- Press and hold the ESC and ENT buttons simultaneously to check for interrupted wires.

### C Display

This shows indicator and setting values. If the sensor input is abnormal or the indicator value cannot be shown, one of the following overflow messages will be shown.

–LOAD: A/D converter minus over  
LOAD: A/D converter plus over

## 1. Names and functions of parts

- FULL: display minus over (less than the minimum display value)
- FULL: display plus over (greater than the maximum display value)
- OVER FULL: Input is outside the input range (negative value)
- OVER FULL: Input is outside the input range (positive value)

### D READ/⏻ button

Press to open the memory and list selection/display screen (page 18).

Press and hold to put the unit in standby or turn it off.

### E Setting buttons

#### MENU

Press when an indicator value or graph is shown to open the Function Menu (page 24).



Select setting items and change setting values.

Use when changing a setting value to change the value, symbol or decimal point position.



Change the screen shown (page 13).

Press when a setting screen is open to select setting items and setting value digits.

#### STRAIN

Press and hold the ▲ button to open static strain display.

#### LOCK

Press and hold the ▼ button to enable/disable the control lock function.

#### CAL

Press and hold the ◀ button to open the sensor value memory screen.

#### TEDS

When a TEDS sensor is connected, press and hold the ▶ button to open the TEDS calibration screen.

### F ENT/HOLD button

Press and hold to start operation of the hold function. Press and hold this button again to disable the hold function.

Press when changing a setting value to confirm the setting item or setting value and move to the next item.

### 1-2. Top panel

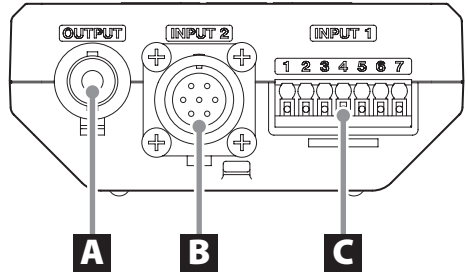

- Connector covers are attached to the connectors. Remove the connector covers to use the connectors.
- For explanation purposes, the illustration above does not show the connector covers.

### A D/A OUTPUT connector

The D/A output is linked to the indicator value.

Connect an external device with a load resistance of 2 kΩ or more.

### B Sensor signal input terminal (INPUT 2)

These connectors are for connecting strain gauge transducers and TEDS sensors.

Compatible plug:

PRC03-12A10-7M10.5 (made by Tajimi Electronics Co., Ltd.)

### C Sensor signal input terminal (INPUT 1)

Terminal bank for connecting strain gauge transducers and TEDS sensors.

# 1. Names and functions of parts

## 1-3. Sensor signal input terminals

Connect one sensor to either INPUT 1 or INPUT 2. Do not connect sensors to both inputs.

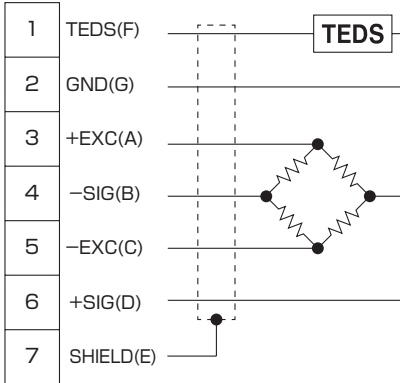

Signal name	Terminal bank terminal number (INPUT 1)	Round connector terminal number (INPUT 2)	Wire color
TEDS	1	F	Orange
GND	2	G	Green
+EXC	3	A	Red
-SIG	4	B	Black
-EXC	5	C	Blue
+SIG	6	D	White
SHIELD	7	E	Yellow

- The wire colors are those that we use in the strain gauge transducers that we make.

## 1-4. Bottom panel

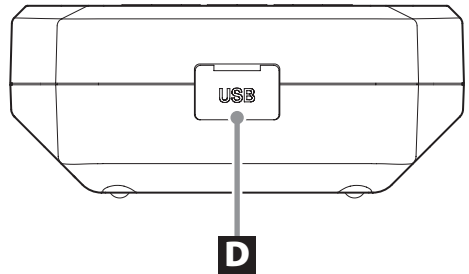

- Connector covers are attached to the connectors. Remove the connector covers to use the connectors.

### **D** USB port

This is a micro-B USB port.

Use to supply bus power to the unit and to transfer data with the dedicated app.

## 1-5. Screen transition diagram

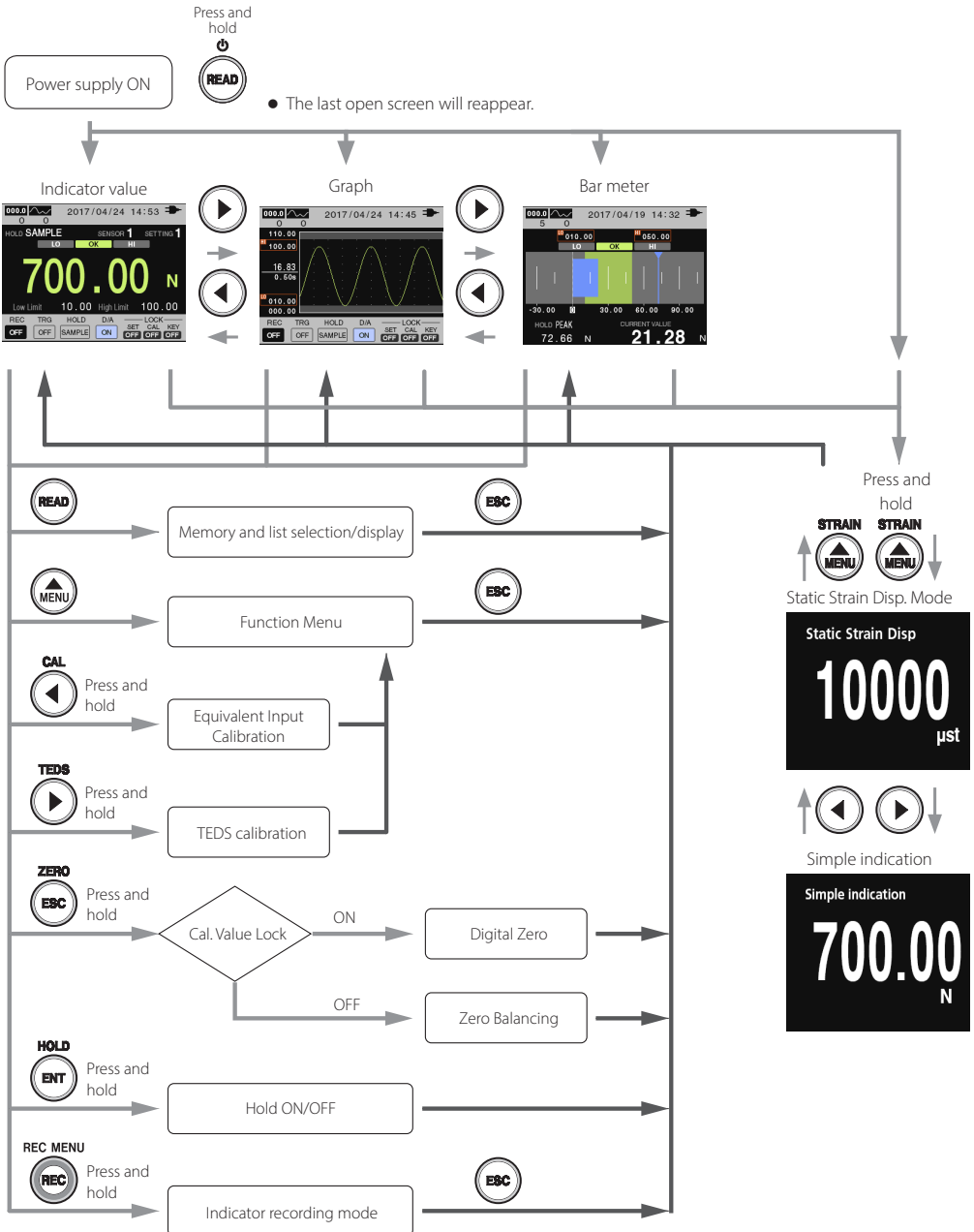

# 1. Names and functions of parts

## 1-6. Home Screen

The indicator value, graph or bar meter screen is shown after the unit is turned on. (The last open screen will reappear.)

Use the ◀ and ▶ buttons to change screen views.

### ATTENTION

The screen will open about 6 seconds after the unit is turned on.

### 1-6-1. Indicator value screen

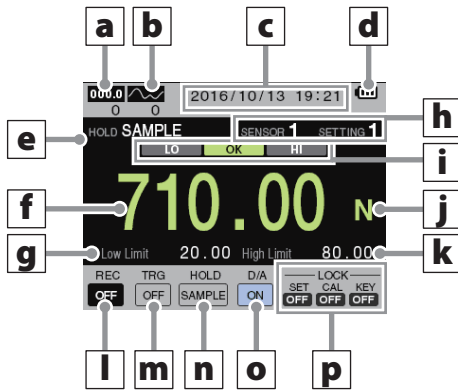

#### a Number of recorded indicator values

This is the number of recorded indicator values (page 18).

#### b Number of recorded graphs

This is the number of recorded data graphs (page 19).

#### c Current time

See "11-2 Date & time setting" on page 61 for details about the date display format and time and date settings.

#### d Power status

: Operating on bus power from the USB port.

: Operating on batteries

- When the battery indicator becomes red, the batteries are almost out of power. Stop using the unit, and change the batteries. If the batteries run out of power while data is being written, the saved data might become unreadable.

#### e Hold Function Setting

This is the currently selected hold setting (page 50).

When the bar meter screen is open, red indicators light while being held and orange indicators light during zone definition.

#### f Indicator value

#### g Low limit value

This is the set low limit value (page 47).

#### h Setting value memory

##### SENSOR

Selected sensor value memory number (page 18)

##### SETTING

Selected setting value memory number (page 18)

#### i Judgment type

##### HI

This lights to show high limit judgment for indicator values higher than the setting value.

##### OK

This lights to show OK judgment when the indicator value is equal to or higher than the low limit and equal to or less than the high limit.

##### LO

This lights to show low limit judgment for indicator values lower than the setting value.

### NOTE

Judgment display operation changes according to the Comp. Pattern, Comp. Output Pattern and Hysteresis settings.

The above example is of operation when the Comp. Pattern setting is LO/OK/HI, the Comp. Output Pattern is "Standard Output" and the Hysteresis setting is 0.

## 1. Names and functions of parts

### j Unit

This is the set position (page 40).

### k High limit value

This is the set high limit value (page 47).

### l REC

Indicator recording mode (page 21).

OFF: No recording

KEY: When REC key pressed

AUTO: When stability detected

ZONE: When hold stops

#### ATTENTION

Setting this to “When stability detected” (AUTO) or “When hold stops” (ZONE) will put the unit into recording standby without starting recording. In this state, pressing the REC button will start recording and make the indicator blue. Press this again to return the unit to recording standby.

### m Trigger mode (TRG)

This shows whether the trigger mode is ON or OFF (page 55).

### n HOLD indicator

This shows the hold setting (page 50).

Press and hold the ENT/HOLD button to change the hold setting.

### o D/A output

This shows whether output is ON or OFF (page 57).

### p LOCK settings

This shows the lock status.

SET: Setting Value Lock (page 59)

CAL: Cal. Value Lock (page 59)

KEY: Control lock

#### NOTE

There are two control lock types.

#### Press and hold ▲+▼

This is indicated on the front panel. This cannot be used to unlock when control lock has been set by pressing and holding ▲+▼.

#### Press and hold ▲+▼

This is not indicated on the front panel, so it can be used to prevent unlocking when not desired.

Press and hold ▲+▼ to unlock this control lock.

This can also be used to unlock when control lock has been set by pressing and holding ▼.

### 1-6-2. Graph screen

This graph shows the indicator value as the vertical axis and the time as the horizontal axis.

The current value is plotted at the right edge and the graph scrolls from right to left.

The top and the bottom of the screen are the same as on the indicator value screen.

For explanations of each part, see “1-6-1 Indicator value screen” on page 14.

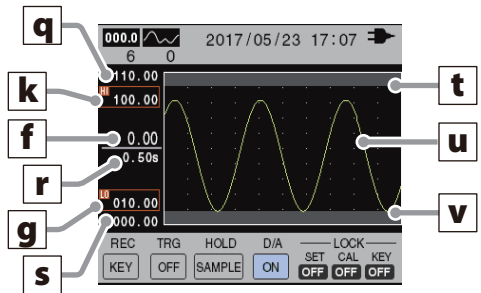

### q Maximum vertical axis value

This is the maximum value on the vertical axis (page 55).

### r Horizontal axis width

This is the width of the horizontal axis (page 55).

- Use the ▼ button to change the time axis.

### s Minimum vertical axis value

This is the minimum value on the vertical axis (page 55).

### t High limit value line

This line corresponds to the high limit value. The area higher than the high limit value line is gray (page 47).

Continued on the next page →

## 1. Names and functions of parts

### u Waveform

Values between the low limit and the high limit are shown in green.

Values above the high limit or below the low limit are shown in red.

### v Low limit value line

This line corresponds to the low limit value. The area lower than the the low limit value line is gray (page 47).

#### 1-6-2-1. Snapshot

Press the ENT button to stop the waveform screen display in its current state.

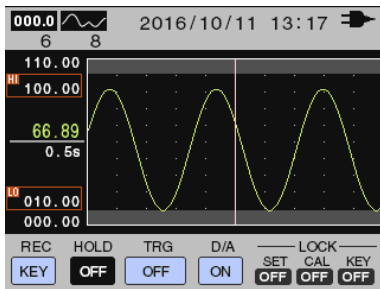

When paused, the cursor appears and the indicator values are shown in green.

Use the ◀ and ▶ buttons to move the cursor so you can check the load at the cursor position.

- The starting position of the cursor on the horizontal axis is the “trigger position” (page 56).
- When the display is stopped, holds cannot be started or stopped using the front panel buttons.
- When the display is stopped, a Δ will be shown in the horizontal axis width (□), and the time from the left edge of the graph to the cursor will also be shown. The time resolution depends on the horizontal axis time setting of the graph (page 21).

Press the ENT button again to resume the waveform screen display.

### 1-6-3. Bar meter screen

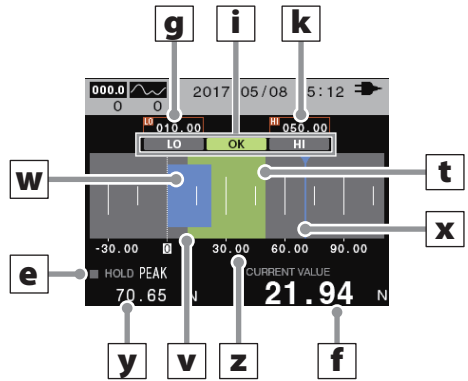

- The indicator value shown on the bar meter screen is the same as the value shown on the indicator value screen.

### w Bar meter

The bar meter shows the indicator value.

### x Hold bar

The hold value is retained when peak hold or bottom hold is selected. Press ESC to reset it.

### y Hold value

This shows the hold value.

### z Scale

The parameter scale can be changed as desired using the “Manual” item for the “Indicator value axis setting (Y)” on the “Graph settings” page.



# 1. Names and functions of parts

## Hold display overview

On the Bar meter screen, the hold value is always shown regardless of whether hold is on or off. This has no effect, however, on values recorded according to the indicator recording mode.

- Press the ESC button to reset the hold value.

**When the OK range is exceeded, the background becomes orange.**

Display example

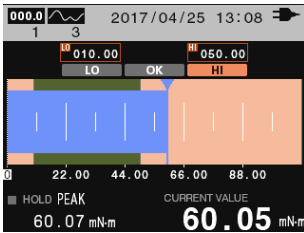

**The meter becomes red when input occurs in the negative direction.**

Display example

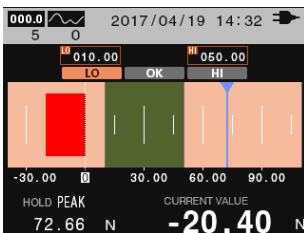

## 1-7. Static Strain Disp. Mode

Set whether to show the input signal with the strain amount unit ( $\mu\text{st}$ ).

Use when checking sensor output and unsteadiness in indicator values, including for sensors and cables, and when making adjustments for discrepancies.



Press and hold the STRAIN button to exit static strain mode.

### NOTE

Static strain is shown using 1-gauge method with a gauge factor of 2.0.

When using a sensor with a common gauge factor of 2.0, there is a relationship of  $1 \text{ mV/V} = 2000 \mu\text{st}$ .

## 1-8. Simple indication

Only the indicator value and unit are shown.



## 2. Shortcut menus

### 2-1. Memory and list selection/display

Press the READ button to open the following screen.

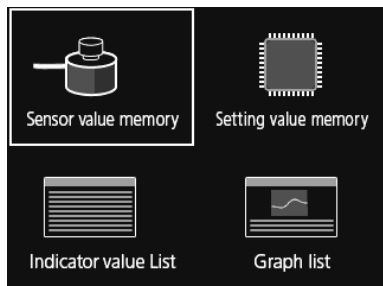

#### 2-1-1. Sensor value memory

Use this to select the sensor value memory.

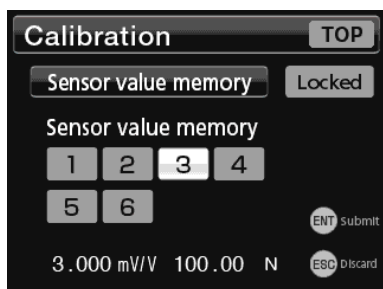

This is the same setting screen as Calibration → Sensor value memory. See “5-2-1 Sensor value memory” on page 35

#### 2-1-2. Setting Memory

Select the setting value memory.

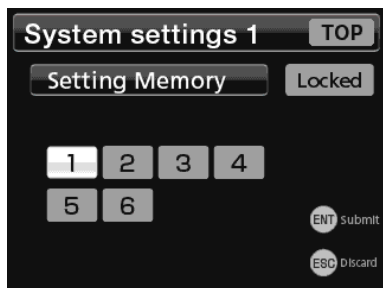

This is the same setting screen as System settings 1 → Setting memory. See “10-1 Setting Memory” on page 57.

### 2-1-3. Indicator value list

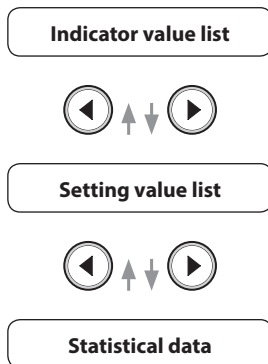

This shows a list of recorded indicator values  
A maximum of 300 indicator values can be saved.

NO.	Date	h : m	Mode	Sensor	Indicator value	>
073	JAN.13	04:07	2	1	17.50	N
074	JAN.13	04:07	2	1	19.07	N
075	JAN.13	04:07	3	1	29.58	N
076	JAN.13	04:08	3	1	21.51	N
077	JAN.13	04:08	3	1	24.35	N
078	JAN.13	04:08	3	1	24.66	N
079	JAN.13	04:08	3	1	25.16	N
080	JAN.13	04:09	3	1	29.88	N
081	JAN.13	04:09	1	1	23.60	N

Use the ◀ and ▶ buttons to scroll through this screen.

< NO.	h : m : s	Hold	Low Limit	Hi Limit
073	04:07:37	---	10.00	100.00
074	04:07:40	---	10.00	100.00
075	04:07:59	SAMPLE	10.00	100.00
076	04:08:06	SAMPLE	10.00	100.00
077	04:08:36	PEAK	10.00	100.00
078	04:08:41	PEAK	10.00	100.00
079	04:08:55	PEAK	10.00	100.00
080	04:09:09	PEAK	10.00	100.00
081	04:09:39	---	10.00	100.00

#### NO.

Recording number

#### Date h : m

Date and time of recording

h: hour

m: minute

### Mode

Indicator recording mode

1: When REC key pressed (KEY)

2: When stability detected (AUTO)

3: When hold stops (ZONE)

### Sensor

Sensor value memory number

### Indicator value

Indicator value

### h:m:s

Time of recording

h: hour m: minute s: second

### Hold

Hold value during zone definition recording

### Low Limit

Low limit value

### Hi Limit

High limit value

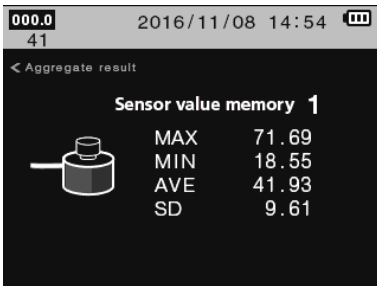

### NOTE

Use the ▲ and ▼ buttons to view different statistical data for sensor value memory numbers.

### Deleting data



When the indicator value list is open, press and hold the REC and ESC buttons at the same time to delete the most recently recorded data.

For other ways to delete data, see "11-5 Recorded data deletion" on page 62.

### 2-1-4. Graph list

#### Graph list



#### Graph analysis



#### Layered display of graphs

This shows a list of recorded data graphs.

A maximum of 8 data graphs can be saved.

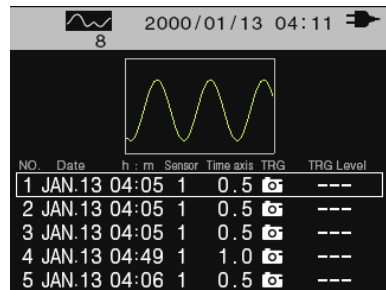

### NO

Recording number

### Date h : m

Date and time of recording

h: hour

m: minute

### Sensor

Sensor value memory number

### Time axis

Horizontal axis time display width (seconds)

### TRG

Trigger type

Camera: Snapshot when the trigger turns off

SLOPE ↑: Rising trigger when trigger on

SLOPE ↓: Falling trigger when trigger on

### TRG LEVEL

Level when trigger is on

## 2. Shortcut menus

### Deleting data



When the graph list is open, press and hold the REC and ESC buttons at the same time to delete the most recently recorded data.

For other ways to delete data, see "11-5 Recorded data deletion" on page 62.

### Graph analysis

Use the ▲ and ▼ buttons to select the graph data, and press the ENT button.

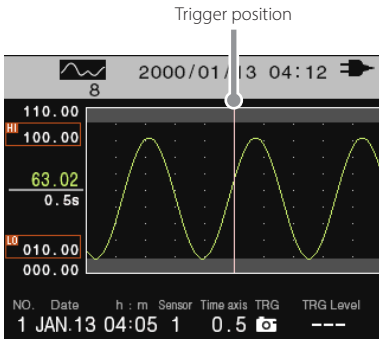

The cursor appears at the trigger position (page 56).

Use the ◀ and ▶ buttons to move the cursor so you can check the load at the cursor position.

- A Δ will be shown in the horizontal axis width (□), and the time from the left edge of the graph to the cursor will also be shown. The time resolution depends on the horizontal axis time setting of the graph (page 21).

Press the ESC button to return to the graph list screen.

### NOTE

On the graph analysis screen, if the recorded graph was in the middle of hold measurement, the hold line appears along with the hold name and hold value at the bottom right of the graph.

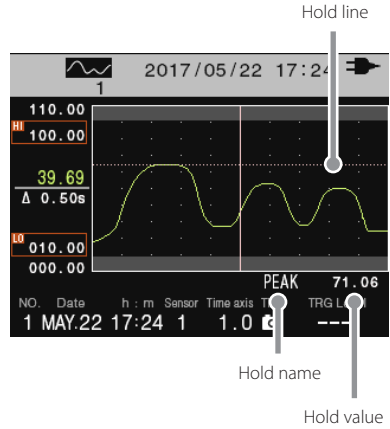

### Layered display of graphs

Press the ENT button when the graph analysis screen is open.

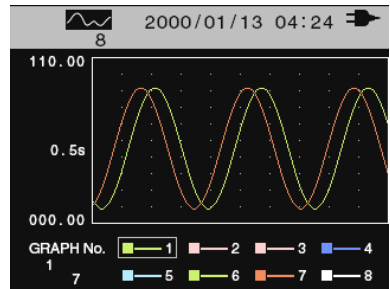

The selection position moves to the graph number (GRAPH No.).

Use the ◀ and ▶ buttons to select a graph that you want to show layered with others and press the ENT button.

You can select multiple layered graphs.

If you want to remove a layered graph, select the number of that graph, and press the ENT button.

Press the ESC button to return to the graph analysis screen.

### ATTENTION

Graphs with different scales cannot be layered together.

### NOTE

When a graph is displayed, press and hold the ◀ or ▶ button to move horizontally in the selected graph.

## 2-2. Indicator recording mode

### 2-2-1. Indicator recording mode

Press and hold the REC button to open the indicator recording mode screen. This is the same setting screen as System settings 2 → Indicator recording mode.

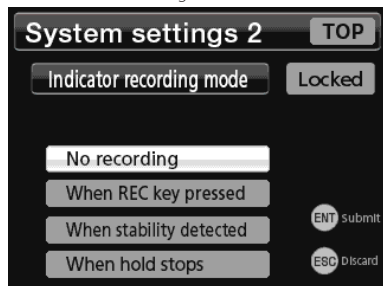

#### No recording (OFF)

No indicator values or graph data will be recorded.

#### When REC key pressed (KEY)

Indicator values will be recorded when the REC button is pressed down.

#### When stability detected (AUTO)

Indicator values will be recorded when stability is detected. For stability detection methods, see “6-2 Motion Detect” on page 43.

#### When hold stops (ZONE)

Indicator values will be recorded when hold goes from ON to OFF.

## 2-2-2. Overwrite oldest first

### Overwrite oldest first

#### ON

When the quantity of data that can be saved reaches its limit, the oldest data will be erased and new data will be saved.

#### OFF

When the quantity of data that can be saved reaches its limit, new data will not be saved.

#### ATTENTION

If “When stability detected (AUTO)” or “When hold stops (ZONE)” is set, pressing the REC button once will start recording. Pressing it again will stop recording.

## 2-2-3. Showing the list of recorded indicator values

See “2-1-3 Indicator value list” on page 18 to check the recorded indicator values.

## 2-3. Recording graph data

When the following conditions are met, you can press the REC button to record graph data.

- The indicator recording mode is not set to “No recording”
- A graph screen is shown and graph display is paused (page 16)

See “2-1-4 Graph list” on page 19 to check the recorded graph data.

#### ATTENTION

If you press the REC button when graph display is not stopped, indicator recording mode will be activated.

The TD-01 Portable always measures with 1000/sec sampling. Depending on the horizontal axis time setting, sampled graph data will be processed as follows before being saved.

Horizontal axis [s]	Recorded data
0.25	Every sample value
0.50	Peak and bottom values for every 2 samples
1.00	Peak and bottom values for every 4 samples
5.00	Peak and bottom values for every 20 samples
10.00	Peak and bottom values for every 40 samples
30.00	Peak and bottom values for every 120 samples

- On graph screens, peaks and bottoms are shown connected, and values are shown at middle points.
- Through TdDataPicker, peaks and bottoms can be read separately.

# 3. Making connections

## 3-1. Connecting with the terminal bank

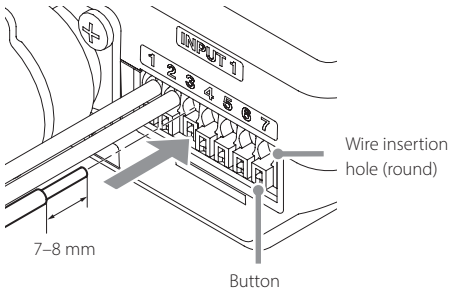

- 1** Remove 7-8 mm of the covering from the wire being connected, and twist it so that the tip does not come apart.

Suitable wiring is 0.2-1.5 mm<sup>2</sup> (24-16 AWG).

- 2** Press the white button beneath the wire insertion hole with your finger or a flat-blade screwdriver, for example.

This will open the metal cover over the wire hole.

- 3** Insert the wire into the hole so that the tip does not come apart.

- 4** Release the white button.

- 5** Pull the wire gently to confirm that it is securely clamped into the hole.

## 3-2. Connecting a strain gauge transducer

### ATTENTION

Incorrect connections or settings could cause damage to sensors.

### 3-2-1. Notes about bridge voltage (applied voltage)

The bridge voltage of this unit is fixed at 2.5 V.

If the permitted excitation voltage for a sensor is lower than the 2.5V, the sensor could be damaged.

### Connecting a TEDS sensor or one with 4 wires

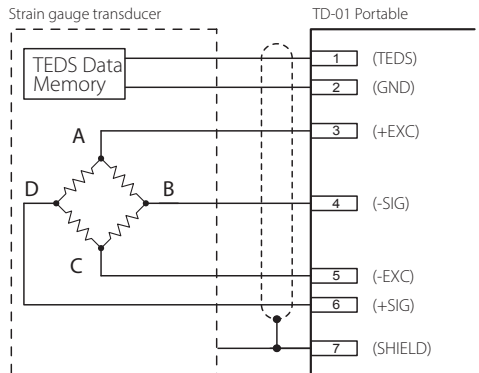

If not using the TEDS function, terminals 1 and 2 can be left open.

### Usable sensor characteristics

- Output between +SIG and -SIG:  $\pm 5.0\text{mV/V}$  or less
- Voltage (current) between +EXC and -EXC: DC 2.5 V  $\pm 5\%$  (30 mA maximum current)

### ATTENTION

Do not connect sensors that do not meet the rated output (output between +SIG and -SIG) and the permitted maximum excitation voltage (voltage between +EXC and -EXC) specifications.

### 3-3. Interrupted wire checking

Press and hold the ESC and ENT buttons to check for interrupted wires and show the results on the display.

If the possibility of an interruption is detected, the location of the possible interruption will be shown in red.

Interruptions can occur not only in strain gauges, but also in load cell cables. Connectors might not be connected properly and wiring might also be incorrect.

- Press the ESC button to return to the previous screen.

Appearance when there are no wiring interruptions

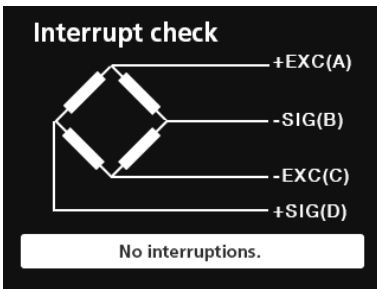

Example of appearance when there are wiring interruptions

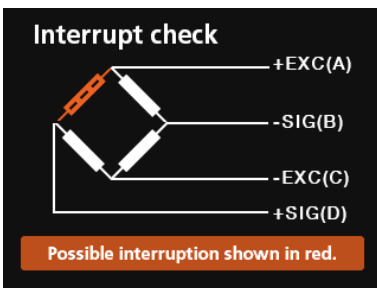

# 4. Settings

## 4-1. Basic operation

### 1 Press the MENU button to open the Function Menu.

- The buttons at the top right can be used to change the display language.

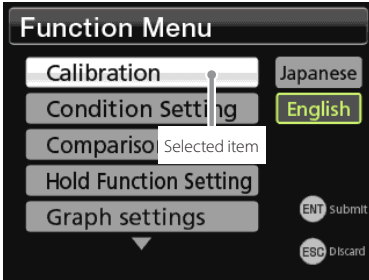

### 2 Use the ▲ and ▼ buttons to select the setting item, and press the ENT button to open the setting screen.

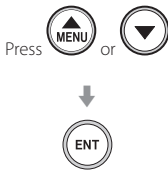

If there are too many selections to be shown on one screen, ▲/▼ will be shown at the top/bottom of the list. Move to the ▲ or ▼ to open the next screen.

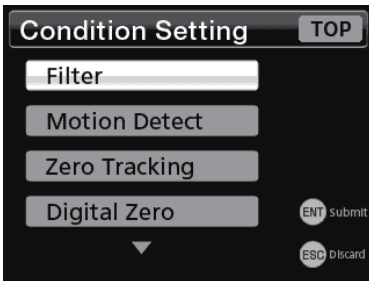

The following screen appears when you select Calibration → Equivalent Input Calibration.

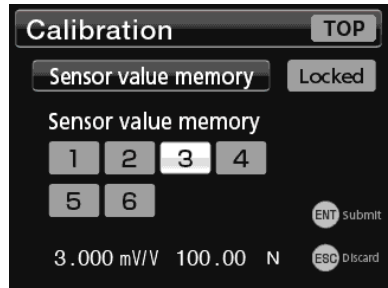

### 3 Changing a series of setting values.

Depending on the menu item, setting screens might appear in a series. When you press the ENT button to confirm a setting value, the next setting screen will open. The setting screens for the lowest level of settings under Calibration, Condition Setting and Hold Function Setting in “4-9 Setting menu list” on page 27 open in series.

If you do not need to change a setting value, press the ENT button to move to the next setting screen.

For example, in the case of Equivalent Input Calibration, the following setting screens appear one after another.

- Sensor value memory
- Rated Output
- Rated Capacity
- Zero Balancing
- D/A Max. Voltage
- Select EU
- Cal. Value Lock

After settings are complete, the Function Menu opens.

- Press the ESC button to return to the higher level screen.



## 4-2. Selecting setting values from options

The current value has a white background.  
Other options have gray backgrounds.

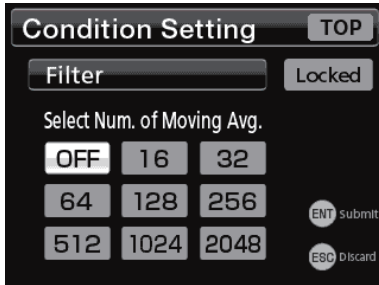

Use the ◀ and ▶ buttons to change the selected option, and press the ENT button. When there are multiple selections, pressing the ▶ button when an option at the right end of a line is selected will select the option at the left end of the next line.

A confirmed item will be shown with a green border.

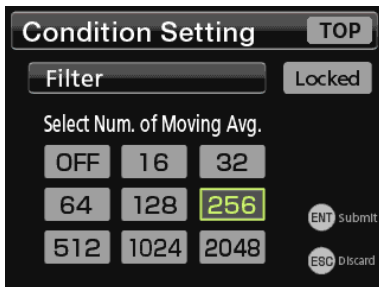

## 4-3. Inputting numerical setting values

The selected digit appears dark with a white background.



Use the ◀ and ▶ buttons to change the selection, and use the ▲ and ▼ buttons to change the value.

The symbol at the left edge can be switched between + and - by pressing either the ▲ or ▼ button.

When you press the ENT button to confirm, the characters turn green.



## 4. Settings

### 4-4. Changing the decimal point position

The decimal point position can only be changed for the Rated Capacity.

- 1 Move the cursor to the decimal point and press the ▲ button to show "0".

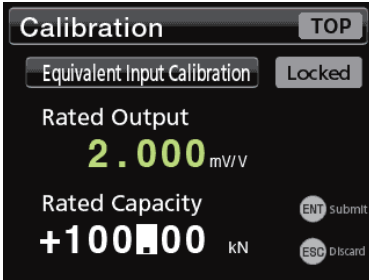

- 2 Move the cursor to the digit where you want to show the decimal point, and press the ▲ or ▼ button until the decimal point is shown.

Each time you press the ▲ or ▼ button, the display changes as follows.



If you press the ENT button when there are two decimal points, an error message appears. Remove one of the decimal points.

- 3 Press the ENT button to confirm the selection.

#### ATTENTION

When a TEDS sensor is connected, if the calibration value lock is not set to ON, the default value will be restored the next time the unit is turned on.

### 4-5. Lock

You can prohibit the changing of calibration and setting values.

When locked, "Locked" appears with a white background at the top right of the setting screen.

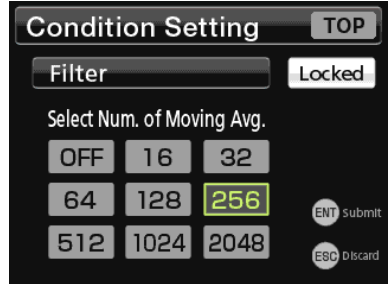

To change a setting value when locked, from the Function Menu, select System settings 1 → Lock, and disable locking for the calibration or setting values (page 34).

When not locked, "Locked" appears with a gray background at the top right of the setting screen.

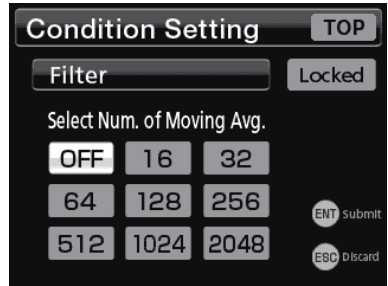

See "4-10 Setting value list" on page 29 for information about lock settings.

#### 4-6. Returning to the Home Screen

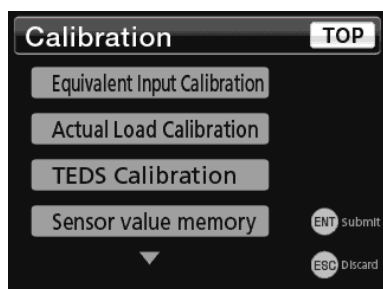

Use the ◀ and ▶ buttons to select TOP, and press the ENT button to return to the Home Screen.

#### 4-7. Viewing the version

**1** Press the MENU button to open the Function Menu.

**2** Press and hold the ◀ and ▶ buttons.

Press the ESC button to return to the Function Menu.

#### 4-8. Initializing all settings

You can initialize all the settings of this unit to their factory default values.

- If you want to initialize all the settings except the calibration values in the selected setting value memory, follow the procedures in “10-7 Reset to the Factory Settings” on page 61.

##### ATTENTION

The following procedure will initialize all the settings in the setting value memory, including calibration values.

**1** Follow the procedures in the previous section to show the version.

**2** Press the ENT button once. When “Initialize OK?” appears, press the ENT button again.

- Press the ESC button to cancel.

#### 4-9. Setting menu list

##### 4-9-1. Function Menu

Function Menu	
— Calibration	(page 33)
— Condition Setting	(page 42)
— Comparison Setting	(page 47)
— Hold Function Setting	(page 50)
— Graph settings	(page 59)
— System settings 1	(page 57)
— System settings 2	(page 59)
— TEDS Settings	(page 63)
— Help	

##### 4-9-2. Calibration

Calibration	
— Equivalent Input Calibration	(page 35)
— Sensor value memory	
— Rated Output	
— Rated Capacity	
— Zero Balancing	
— D/A Max. Voltage	
— Select EU	
— Cal. Value Lock	
— Actual Load Calibration	(page 36)
— Sensor value memory	
— Zero Balancing	
— Rated Capacity	
— D/A Max. Voltage	
— D/A Full Scale	
— Select EU	
— Max. Disp. Value	
— Cal. Value Lock	
— TEDS calibration	(page 38)
— Rated Output	
— Rated Capacity	
— Zero Balancing	
— Select EU	
— Cal. Value Lock	
— Sensor value memory	(page 39)
— Min. Grid	(page 40)
— Max. Disp. Value	(page 40)
— Select EU	(page 40)
— Sensor input logic	(page 41)

## 4. Settings

### 4-9-3. Condition Setting

Condition Setting	
Filter	(page 42)
Select Num. of Moving Avg.	
Auto Digital Filter	
Motion Detect	(page 43)
Time	
Width	
Zero Tracking	(page 44)
Time	
Width	
Digital Zero Offset	(page 45)
Digital Zero	(page 45)
Digital Zero Limit Value	
Clear Digital Zero	
Select Data Output	(page 46)

### 4-9-4. Comparison Setting

Comparison Setting	
Comp. Value Setting	(page 47)
High limit input (HI)	
Low limit input (LO)	
Comp. Mode Setting	(page 47)
Hysteresis	(page 48)
Nearly Zero	(page 49)

### 4-9-5. Hold Function Setting

Hold Function Setting	
Hold Mode	(page 50)
Zone Definition	(page 54)
Auto Zero	(page 54)

### 4-9-6. Graph settings

Graph settings	
Time axis setting (X)	(page 55)
Indicator value axis setting (Y)	(page 55)
Shown high limit value	
Shown low limit value	
Trigger mode	(page 55)
Trigger	(page 55)
Trigger polarity	
Trigger level	
Trigger position	

### 4-9-7. System settings 1

System settings 1	
Setting Memory	(page 57)
D/A Converter	(page 57)
D/A output	
D/A Zero	
D/A Full Scale	
D/A Max. Voltage	
D/A CAL TEST	
Lock	(page 59)
Cal. Value Lock	
Setting value lock	
Brightness	(page 59)
Backlight dimmer	
Auto power off	(page 60)
Languages	(page 60)
Reset to the Factory Settings	(page 61)

### 4-9-8. System settings 2

System settings 2	
Device number	
Date & time setting	
Date display format	
Date & time setting	
Battery type	
Indicator recording mode	
Overwrite oldest first	
Recorded data deletion	
Delete newest data	
Delete all	

### 4-9-9. TEDS Settings

TEDS Settings	
TEDS Data	(page 63)
TEDS Data Change	(page 64)
Restore TEDS Data	(page 65)

### 4-10. Setting value list

#### 4-10-1. Calibration

Item	Setting	Format	Unit display	Default value	Setting range/options	Cal. Value Lock	Setting value lock	Setting value memory
Equivalent Input Calibration	Sensor value memory	Options		1	1 to 6			
	Rated Output	Input	mV/V	3.000	0.300 to 5.000	✓		
	Rated Capacity	Input	Set unit	100.00	00000 to 99999	✓		
	Zero Balancing				Execute	✓		
	Select EU	Options		N	dN, N, kN, lbf, klf, g, kg, sht, ton, mN-m, N-m, kN-m, Pa, kPa, MPa, psi, mBar, Bar, m/s <sup>2</sup> , G, Gal, mm, $\mu$ st, none	✓		
Cal. Value Lock	Options		OFF	OFF, ON				
Actual Load Calibration	Sensor value memory	Options		1	1 to 6			
	Zero Balancing				Execute	✓		
	Rated Capacity	Input	Set unit	100.00	00000 to 99999	✓		
	Select EU	Options		N	dN, N, kN, lbf, klf, g, kg, sht, ton, mN-m, N-m, kN-m, Pa, kPa, MPa, psi, mBar, Bar, m/s <sup>2</sup> , G, Gal, mm, $\mu$ st, none	✓		
	Max. Disp. Value	Input	Set unit	110.00	00000 to 99999	✓		
Cal. Value Lock	Options		OFF	OFF, ON				
TEDS calibration	Rated Output	Display	mV/V		0.300 to 5.000	✓		
	Rated Capacity	Display	Automatic		00000 to 99999	✓		
	Zero Balancing		Set unit		Execute	✓		
	Select EU	Options		N	N, kN, kPa, MPa, g, kg, sht, ton, mN-m, N-m, kN-m, none	✓		
	Cal. Value Lock	Options		OFF	OFF, ON			
Sensor value memory				1	1 to 6	✓		
Min. Grid		Options		1	1, 2, 5, 10	✓		
Max. Disp. Value		Input	Set unit	110.00	00000 to 99999	✓		
Select EU		Options		N	dN, N, kN, lbf, klf, g, kg, sht, ton, mN-m, N-m, kN-m, Pa, kPa, MPa, psi, mBar, Bar, m/s <sup>2</sup> , G, Gal, mm, $\mu$ st, none	✓		
Sensor input logic		Options		Standard	Standard, Reversed	✓		

Calibration items will not be reset when the procedures in "10-7 Reset to the Factory Settings" on page 61 are conducted.

## 4. Settings

### 4-10-2. Condition Setting

Item	Setting	Format	Unit display	Default value	Setting range/options/operation	Cal. Value Lock	Setting value lock	Setting value memory
Filter	Select Num. of Moving Avg.	Options		16	OFF, 16, 32, 64, 128, 256, 512, 1024, 2048		✓	✓
	Auto Digital Filter	Options		ON	ON, OFF		✓	✓
Motion Detect	Time	Input	Seconds	1.5	0.0 to 9.9		✓	✓
	Width	Input	Set unit	000.20	00000 to 00999		✓	✓
Zero Tracking	Time	Input	Seconds	0.0	0.0 to 9.9		✓	✓
	Width	Input	Set unit	000.00	00000 to 00999		✓	✓
Digital Zero Offset		Input	Set unit	000.00	-19999 to 19999		✓	
Digital Zero	Digital Zero Limit Value	Input	Set unit	999.99	00000 to 99999		✓	
	Clear Digital Zero	Options		Skip	Execute, Skip		✓	
Select Data Output		Options		Displayed output	Hold value is output in coordination with display, input is output as is		✓	✓

### 4-10-3. Comparison Setting

Item	Setting	Format	Unit display	Default value	Setting range/options	Cal. Value Lock	Setting value lock	Setting value memory
Comp. Value Setting	High limit input (HI)	Input		100.00	-99999 to 99999		✓	✓
	Low limit input (LO)	Input		10.00	-99999 to 99999			
Comp. Mode Setting		Options		Compare Always	Compare Always, Compare During Stable, Compare Except Nearly Zero, Compare During Stable Except Nearly Zero, Compare During Held, Disable comparison		✓	✓
Hysteresis		Input	Set unit	000.00	00000 to 99999		✓	✓
Nearly Zero		Input	Set unit	001.00	00000 to 09999		✓	✓

### 4-10-4. Hold Function Setting

Item	Setting	Format	Unit display	Default value	Setting range/options	Cal. Value Lock	Setting value lock	Setting value memory
Hold Mode		Options		SAMPLE	OFF, SAMPLE, PEAK, BOTTOM		✓	✓
Zone Definition		Options		OFF	ON, OFF		✓	✓
Auto Zero		Options		OFF	ON, OFF		✓	✓

### 4-10-5. Graph settings

Item	Setting	Format	Unit display	Default value	Setting range/options	Cal. Value Lock	Setting value lock	Setting value memory
Time axis setting (X)		Options	s	0.25	0.25, 0.5, 1.0, 5.0, 10.0, 30.0		✓	✓
Indicator value axis setting (Y)		Options		Auto	Auto, Manual		✓	✓
	Displayed high limit value	Input		110.00	-99999 to 99999		✓	✓
	Displayed low limit value	Input		000.00	-99999 to 99999		✓	✓
Trigger mode		Options		OFF	OFF, ON		✓	✓
Trigger	Trigger polarity	Options		SLOPE↑	SLOPE↑, SLOPE↓		✓	✓
	Trigger level	Input		50.00	-99999 to 99999		✓	✓
	Trigger position	Options	%	50	0, 10, 20, 30, 40, 50, 60, 70, 80, 90, 100		✓	✓

### 4-10-6. System settings 1

Item	Setting	Format	Unit display	Default value	Setting range/options	Cal. Value Lock	Setting value lock	Setting value memory
Setting value memory		Options		1	1 to 6		✓	
D/A Converter	D/A output	Options		ON	ON, OFF			
	D/A Zero	Input	Set unit	000.00	-99999 to 99999		✓	
	D/A Full Scale	Input	Set unit	100.00	-99999 to 99999		✓	
	D/A Max. Voltage	Options	V	10V	1, 2		✓	
Lock	D/A CAL TEST	Input	V					
	Cal. Value Lock	Options		OFF	OFF, ON			
Brightness	Setting value lock	Options		OFF	OFF, ON			
	Brightness	Options		Standard	OFF, Dark, Normal, Bright		✓	
Auto power off	Backlight dimmer	Input	Second	00	00 (disabled) to 60			
		Options		OFF	OFF, 2 min., 5 min., 10 min., 30 min.		✓	
Languages		Options		Japanese	Japanese, English		✓	
Reset to the Factory Settings		Options		OFF	Execute, Skip			

## 4. Settings

### 4-10-7. System settings 2

Item	Setting	Format	Unit display	Default value	Setting range/options	Cal. Value Lock	Setting value lock	Setting value memory
Device number		Input		0000	0000 (number only)			
Date & time setting	Date display format	Options		[YYYY/MM/YY], [MM/DD/YYYY]	[YYYY/MM/DD], [DD/MM/YYYY], [MM/DD/YYYY]			
	Date & time setting	Input			YYYY/MM/DD HH:MM (depends on display format)			
Battery type		Options		Alkaline	Alkaline/NiMH			
Indicator recording mode		Options			No recording (OFF), When REC key pressed (KEY), When stability detected (AUTO) (record at time stability reached; disabled near zero), When hold stops (ZONE) (record at instant HOLD stopped)			
	Overwrite oldest first	Options		OFF	ON, OFF			
Recorded data deletion	Delete newest data	Options		Skip	Execute, Skip			
	Delete all	Options		Skip	Execute, Skip			

### 4-10-8. TEDS Settings

Item	Setting	Format	Unit display	Default value	Setting range/options	Cal. Value Lock	Setting value lock	Setting value memory
TEDS Data		Display	Capacity unit, mV/V, Ω, V, Year/ Month/ Date	/	Serial number, Rated capacity, Rated output, Bridge Element Impedance, Max. Exc. Level, Calibration Date			
TEDS Data Change	Accept Changing	Input		00000	00000 to 99999		✓	
	Calibration Date Input	Input	Year: Month: Date	-: -	Year/Month/Date		✓	
	Writing Cal. Data			/	Write		✓	
Restore TEDS Data	Accept Changing	Input		00000	00000 to 99999		✓	
	Writing Restore Data			/	Write		✓	



Connecting the unit with a strain gauge transducer and setting how the indicator values will be shown is called "calibration". The following three calibration methods can be used with the unit.

## 1. Equivalent input calibration

This calibration method does not depend on actual loads. It only requires the input of the strain gauge transducer rated output (mV/V) and the rated capacity (value you want shown). Use this to calibrate easily when an actual load cannot be applied.

Examples:

Weight

100kN rated capacity, 2.001mV/V rated output

Pressure

10.00MPa rated capacity, 2.002mV/V rated output

Torque

15.00N-m rated capacity, 2.502mV/V rated output

In this manner, by recording values from test results tables, the gain can be determined automatically and shown.

## 2. Actual Load Calibration

This calibration method measures the values of actual loads on the strain gauge transducer.

By applying an actual load that is as close as possible to the maximum measured value, calibration with less error is possible.

## 3. TEDS calibration

This calibration method uses the strain gauge transducer rated output (mV/V) and rated capacity that are recorded in TEDS memory.

Note, however that equipment with TEDS memory includes both 1kbit and 4kbit devices, but the unit only supports 4kbit.

## Sensor check before calibrating

After connecting a sensor and turning the unit on, calibration is not possible if the indicator value is unstable or an error appears. If this occurs, press and hold the STRAIN button to enable static strain mode, and check the indicator value. In this mode, the sensor output itself is shown as a strain amount unit ( $\mu\text{st}$ ), so input between 0 and  $\pm 5.0$  mV/V will be shown as a value from 0 to  $\pm 10000$   $\mu\text{st}$ .

A strain gauge transducer should have written test results with contents such as the following.

Rated capacities: weight, pressure, etc. (unit: kN, MPa, etc.)

Rated output: voltage (unit: mV/V)

Linearity: %R.O.

Hysteresis: %R.O.

Maximum excitation voltage: V (bridge voltage)

Input terminal resistance:  $\Omega$

Output terminal resistance:  $\Omega$

Zero balance: %R.O.

- The data necessary for equivalent input calibration are rated capacity and rated output.
- Some of this data is written to the internal memory of the TEDS sensor.

## 5. Calibration

### 5-1. Procedures shared by all calibration methods

The three calibration methods are equivalent input calibration, actual load calibration and TEDS calibration. All the calibration methods have the same procedures before and after calibration.

An overview of the calibration procedures is shown below.

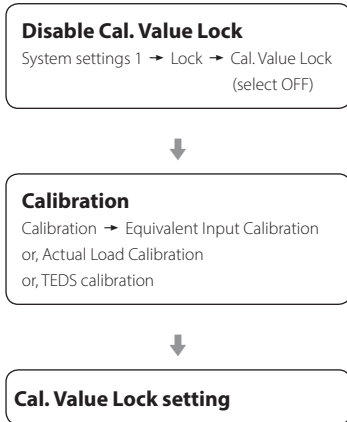

First, we will explain the procedures to be conducted before and after calibration. Then, we will explain the procedures for equivalent input calibration, actual load calibration and TEDS calibration.

#### 5-1-1. Locking and unlocking calibration values

Usually, the unit is used with Cal. Value Lock set to ON. Before calibration, Cal. Value Lock must be set to OFF. After calibration, set Cal. Value Lock to ON again.

**1** Press the MENU button to open the Function Menu.

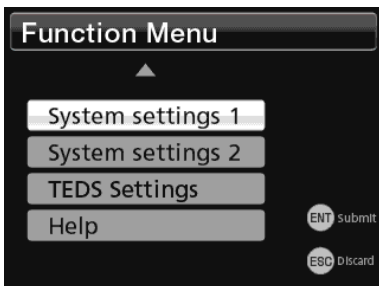

**2** Use the ▲ ▼ buttons to change the selection, and select in order System Settings 1 → Lock

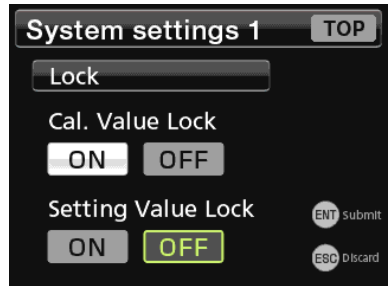
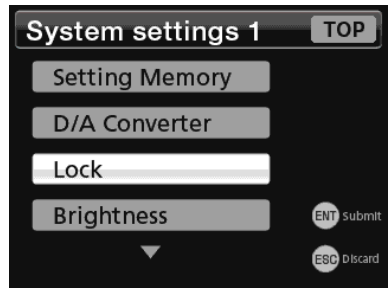

**3** Use the ◀ ▶ buttons to select OFF or ON.

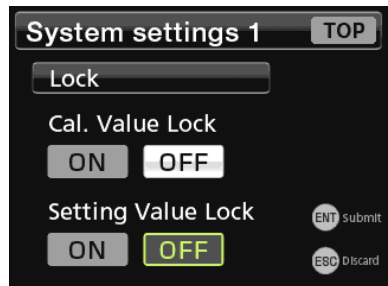

- 4** Press the ENT button to confirm the selection.

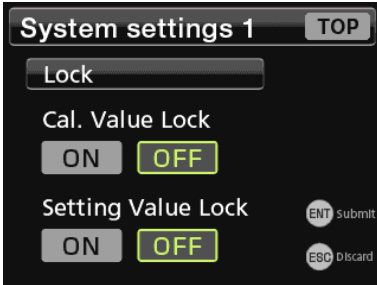

- 5** Press the ESC button to exit setting mode.

### ATTENTION

- The ZERO button function depends on the Cal. Value Lock setting. When Cal. Value Lock is ON, press the ZERO button to use the Digital Zero function. When Cal. Value Lock is OFF, press it to use the Zero Balancing function.
- In order to prevent accidental changes to the calibration value, set Cal. Value Lock to ON after calibration.

### NOTE

See "4-10 Setting value list" on page 29 for information about settings that cannot be changed when Cal. Value Lock is ON.

## 5-2. Equivalent input calibration

This method determines the calibration value by recording rated output and rated capacity values from a test results table. Use this to calibrate easily when an actual load cannot be applied.

An overview of the equivalent input calibration procedures is shown below.

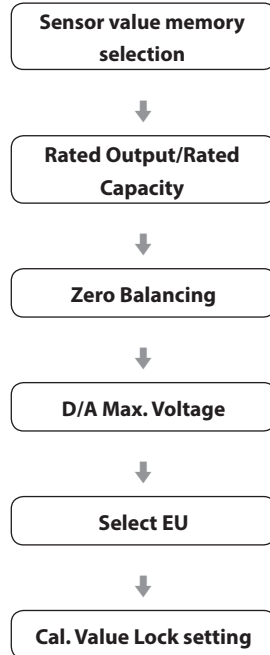

- See "10-2 D/A Converter" on page 57 for information about D/A settings.

### 5-2-1. Sensor value memory

This unit can save six types of calibration values for each connected sensor.

Select the memory number for saving the calibration value.

## 5. Calibration

### 5-2-2. Rated Output

Input range: 0.300–5.000 mV/V

Set the rated output of the strain gauge transducer being used.

### 5-2-3. Rated Capacity

Set the rated capacity of the strain gauge transducer being used.

#### NOTE

The decimal point position set here will be used as the indicator value decimal point position.

#### ATTENTION

When using D/A, the rated capacity is set as the D/A Full Scale value.

### 5-2-4. Zero Balancing

With no load on the sensor, press the ENT button.

During zero balancing, a pop-up appears to show that it is in progress. When zero balancing completes, the setting screen for the next procedure appears.

To skip zero balancing, select Skip.

- If a calibration error appears, conduct countermeasures according to the error message.

### 5-2-5. Select EU

Options: dN, N, kN, lbf, klbf, g, kg, sht, ton, mN·m, N·m, kN·m, Pa, kPa, MPa, psi, mBar, Bar, m/s<sup>2</sup>, G, Gal, mm, μst, none

Select the unit that corresponds to the indicator value.

### 5-2-6. Cal. Value Lock

To prevent unintended changes to the calibration value, Cal. Value Lock should usually be set to ON.

## 5-3. Actual Load Calibration

Calibrate by applying an actual load to the sensor.

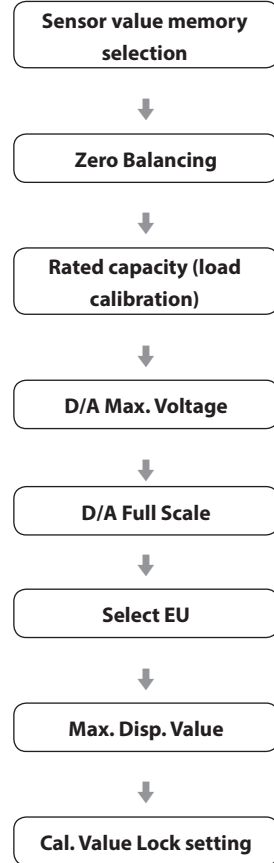

### 5-3-1. Sensor value memory

This unit can save six types of calibration values for each connected sensor.

Select the memory number for saving the calibration value.

### 5-3-2. Zero Balancing

With no load on the sensor, press the ENT button.

During zero balancing, a pop-up appears to show that it is in progress. When zero balancing completes, the setting screen for the next procedure appears.

To skip zero balancing, select Skip.

- If a calibration error appears, conduct countermeasures according to the error message.

### 5-3-3. Rated capacity (load calibration)

- 1 Set the rated capacity and press the ENT button.

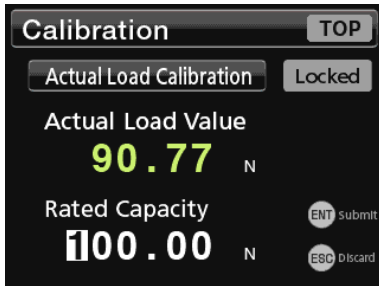

- 2 With an actual load applied to the sensor, press the ENT button.



This shows the load calibration results.

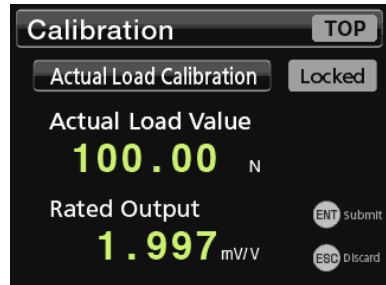

Check the load calibration results. If there are no problems, press the ENT button to confirm them and proceed to the next step.

If there is a problem, press the ESC button and restart from step 2.

- If a calibration error appears, conduct countermeasures according to the error message.

#### ATTENTION

The Rated Capacity is set to the D/A Full Scale value.

#### NOTE

The decimal point position set here will be used as the indicator value decimal point position.

- 3 Make the D/A setting.

With the "10-2-2. D/A Zero" value as the reference, set the span for the indicator values output to D/A.

When the value has the "10-2-3. D/A Full Scale" setting value added, the "10-2-4. D/A Max. Voltage" setting value voltage is output.

#### NOTE

For information about D/A settings, see "10-2 D/A Converter" on page 57

## 5. Calibration

### 5-3-4. Select EU

Select the unit that corresponds to the indicator value.

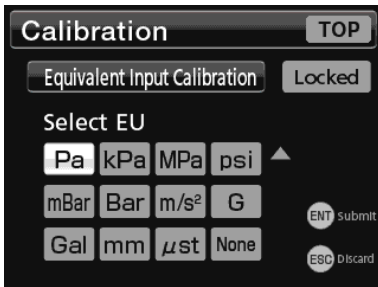
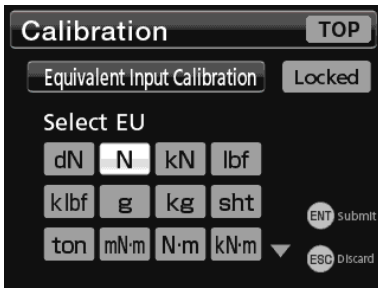

Options: dN, N, kN, lbf, k lbf, g, kg, sht, ton, mN·m, N·m, kN·m, Pa, kPa, MPa, psi, mBar, Bar, m/s<sup>2</sup>, G, Gal, mm, μst, none

### 5-3-5. Max. Disp. Value

Set the highest displayed value (page 40).

### 5-3-6. Cal. Value Lock

To prevent unintended changes to the calibration value, Cal. Value Lock should usually be set to ON.

### 5-4. TEDS calibration

A TEDS sensor has calibration information, including rated output and rated capacity, stored in its memory. TEDS calibration reads this calibration information to automatically record calibration values.

- Press and hold the TEDS button to open the TEDS calibration screen without needing to select the Function Menu.

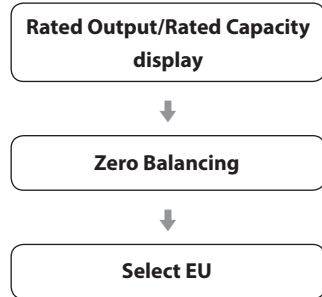

- When conducting TEDS calibration, sensor value memory is not overwritten.

#### ATTENTION

- The TD-01 Portable does not store calibration values read from TEDS. If Cal. Value Lock is ON, calibration values will not be read from TEDS sensors when the power is turned on. Turn Cal. Value Lock OFF to apply the calibration values of TEDS sensors every time.
- To use it with Cal. Value Lock ON, open the equivalent input calibration screen (sensor value memory screen), select the sensor value memory you want to save, and press the ENT button to show the equivalent calibration value. Press the ENT button again to save the calibration value.

### 5-4-1. Rated Output/Rated Capacity display

After reading the TEDS data, the Rated Output/Rated Capacity is shown.

#### Rated capacity digit shown during TEDS calibration

TEDS sensor Rated Capacity	Unit	Indicator value
1	N, kN	01.000
2	N, kN	02.000
3	N, kN	03.000
4	N, kN	04.000
5	N, kN	05.000
10	N, kN	010.00
20	N, kN	020.00
30	N, kN	030.00
40	N, kN	040.00
50	N, kN	050.00
100	N, kN	0100.0
200	N, kN	0200.0
300	N, kN	0300.0
400	N, kN	0400.0
500	N, kN	0500.0

#### NOTE

- TEDS data is automatically read when the power is turned on.
- The rated capacity decimal point position set here will be used as the indicator value decimal point position.
- The Max. Disp. Value is set as 110% of the Rated Capacity.

#### ATTENTION

The bridge voltage of this unit is fixed at 2.5 V.  
The bridge voltage will be 2.5 V regardless of the maximum safe excitation voltage of the sensor.

### 5-4-2. Zero Balancing

With no load on the sensor, press the ENT button.  
During zero balancing, a pop-up appears to show that it is in progress. When zero balancing completes, the setting screen for the next procedure appears.

To skip zero balancing, select Skip.

- If a calibration error appears, conduct countermeasures according to the error message.

### 5-4-3. Select EU

Options: dN, N, kN, lbf, klpf, g, kg, sht, ton, mN·m, N·m, kN·m, Pa, kPa, MPa, psi, mBar, Bar, m/s<sup>2</sup>, G, Gal, mm,  $\mu$ st, none  
Select the unit that corresponds to the indicator value.

- If a sensor with TEDS built in is connected, the read unit will be set.

### 5-4-4. Cal. Value Lock

To prevent unintended changes to the calibration value, Cal. Value Lock should usually be set to ON.

#### ATTENTION

If Cal. Value Lock is ON, automatic calibration will not occur when the unit is turned on.

### 5-5. Sensor value memory

Use this to select the sensor value memory.

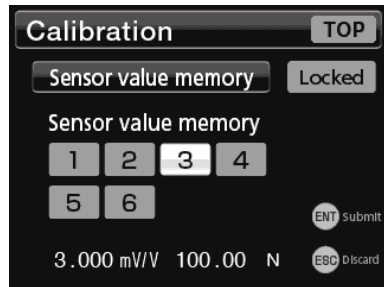

Set setting value memory settings using System settings 1 (page 57) Equivalent Input Calibration and Actual Load Calibration.

Calibration values saved in the selected sensor value memory are shown at the bottom of the screen.

## 5. Calibration

### 5-6. Select Min. Grid

Set the minimum digital change of the indicator value.

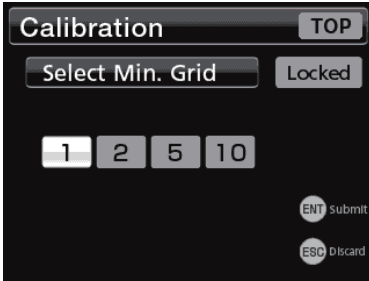

Options: 1, 2, 5, 10

### 5-7. Max. Disp. Value

Set the highest displayed value.

The default value is set at 110% of the Rated Capacity.  
If this value is exceeded, "±FULL: Plus Value Over (Over Max. Disp. Value)" appears in a pop-up message.



#### ATTENTION

The input value will be checked with a value converted to match the input signal.

### 5-8. Select EU

Select the indicator value unit.

Select the unit that corresponds to the indicator value.

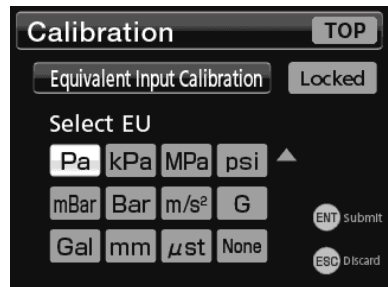
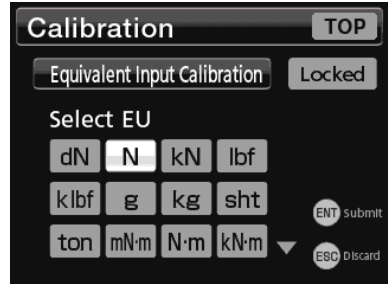

Options: dN, N, kN, lbf, kIbf, g, kg, sht, ton, mN-m, N-m, kN-m, Pa, kPa, MPa, psi, mBar, Bar, m/s<sup>2</sup>, G, Gal, mm, μst, none

#### NOTE

The display unit is shown next to the indicator value, but it has no effect on internal calculations.

For example, the calibration value will not change even if the display unit is changed from "N" to "kN".



### 5-9. Sensor input logic

The sensor input logic can be reversed artificially. Normally, "Standard" should be used.

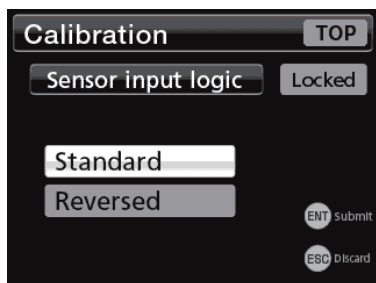

#### NOTE

- "Reversed" does not electrically reverse the input.
- After changing this setting, always conduct zero balancing or reset digital zero.

### 5-10. Zero Balancing

You can conduct Zero Balancing calibration even without resetting the calibration value.

#### 1 Set Cal. Value Lock to OFF.

See "5-1-1 Locking and unlocking calibration values" on page 34.

#### 2 With no load on the sensor, press and hold the ZERO button.

During zero balancing, a pop-up appears to show that it is in progress.

If a calibration error appears, conduct countermeasures according to the error message.

#### 3 Set Cal. Value Lock to ON.

### 5-11. Digital Zero

The current indicator value becomes zero. When Cal. Value Lock is set to ON, press and hold the ZERO button.



- The range for Digital Zero is the range set by Digital Zero Limit.
- Digital Zero is cleared by putting the unit into standby or using Clear Digital Zero.

#### ATTENTION

- This only functions when Cal. Value Lock is ON and Enable Digital Zero is ON.
- When Cal. Value Lock is OFF, this function is replaced by Zero Balancing.

# 6. Condition Settings

## 6-1. Filter

### 6-1-1. Select Num. of Moving Avg.

Set the moving average number for the measured data.

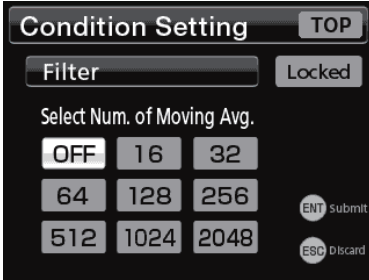

Options: OFF, 16, 32, 64, 128, 256, 512, 1024, 2048

#### NOTE

The moving average filter only affects the display. It does not affect graph data and hold measurements.

### 6-1-2. Auto Digital Filter

When the input signal is not changing, the unit can temporarily set the filter's moving average number to 1024, reducing indicator value unsteadiness.

This function has no effect on measured values. It is only used for the display of indicator values and bar meters and does not function during graph display or hold execution.

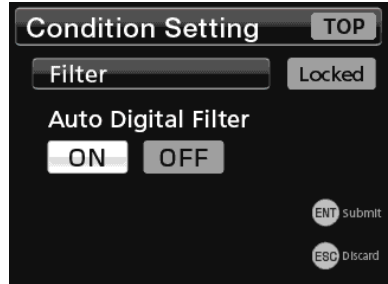

Options: ON, OFF

### 6-2. Motion Detect

Set the parameters used to detect stability.

The indicator value is judged to be stable if a difference less than the set width occurs between the current indicator value and the indicator value 100 mSec before, and this continues for the set time.

The Motion Detect function is closely related to the comparison mode. See "7-2. Comp. Mode Setting" for details.

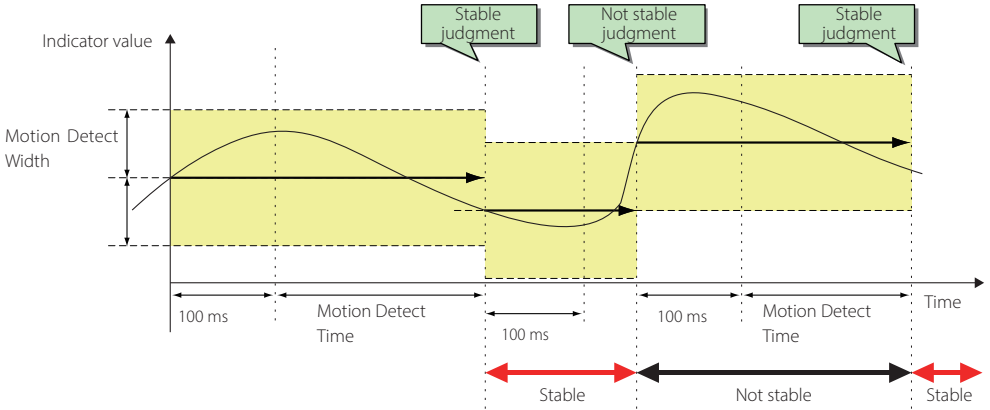

#### 6-2-1. Time



#### 6-2-2. Width



## 6. Condition Setting

### 6-3. Zero Tracking

This function automatically tracks drift and other gradual changes to the zero point.

With Zero Tracking, when the zero point moves no more than the set width, the indicator value is automatically adjusted to zero each set time interval.

This only functions when Cal. Value Lock is ON and Enable Digital Zero is ON.

Zero Tracking will not function if its Time is set to 0.0 seconds and its Width is set to 0.0.

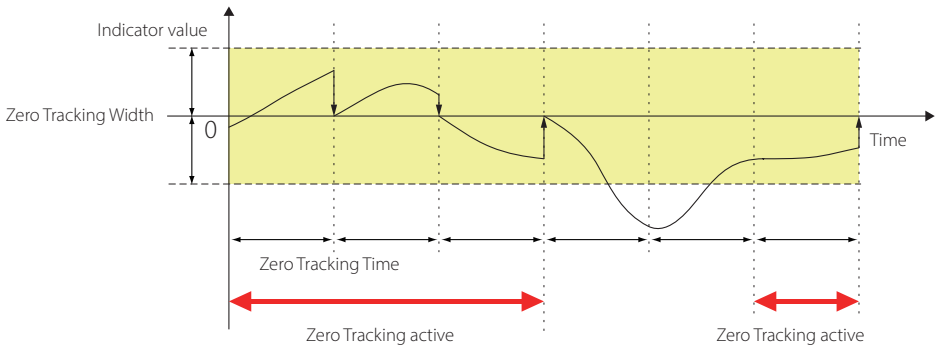

#### 6-3-1. Time

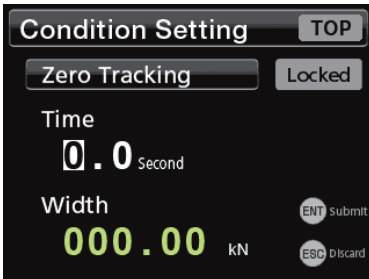

#### 6-3-2. Width

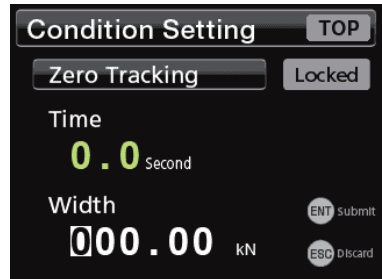

### 6-4. Digital Zero Offset

The set value is subtracted from the measured value (digital zero).

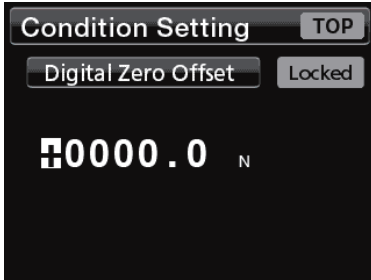

### 6-5. Digital Zero

#### 6-5-1. Enable Digital Zero

When Enable Digital Zero is set to OFF, the Digital Zero function will not be executed when you press and hold the ZERO button.

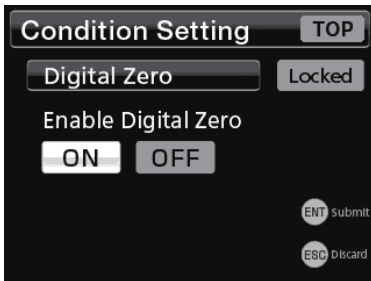

#### 6-5-2. Digital Zero Limit Value

Set the range for Digital Zero capture. (The setting value unit is the same as for the indicator value.)

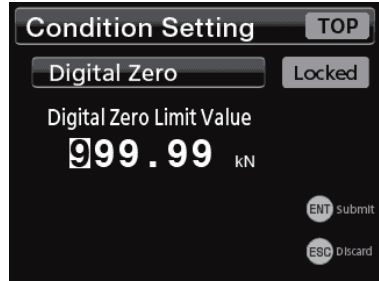

#### ATTENTION

If the current sensor input value exceeds the Digital Zero Limit setting value, "Digital Zero Limit error" appears and the indicator value does not become zero.

Even when Enable Digital Zero is set to ON, if Cal. Value Lock is set to OFF, the zero function will not be executed even when the ZERO button is pressed and held.

#### NOTE

If you execute the Clear Digital Zero function, the current sensor input value is shown with the Zero Balancing value as zero.

#### 6-5-3. Clear Digital Zero

The display adjustment that has been made with Digital Zero is reverted so that the unadjusted value is shown again.

When Zero Balancing has been conducted, the value is shown as zero.

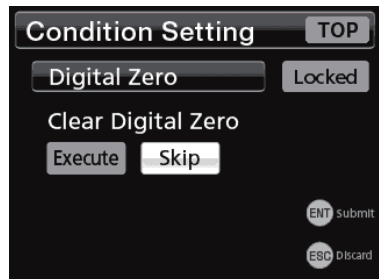

## 6. Condition Setting

---

### 6-6. Select Data Output

Select the data output from the D/A Converter.

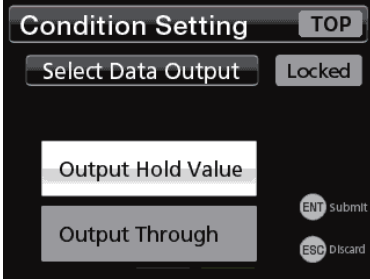

Select Data Output has the following two options.

- The hold value is output in coordination with the display.
- The input is output as is.

## 7. Comparison Setting

### 7-1. Comp. Value Setting

Use this function to set the high limit and low limit values, compare them with indicator values, and turn judgment display ON for each one.

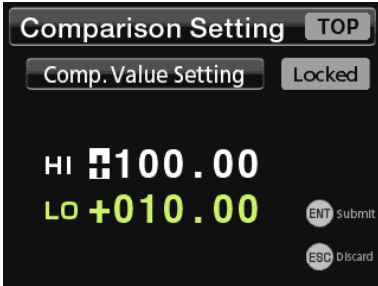

HI: high limit value

LO: low limit value

#### ATTENTION

If the condition that the low limit value be less than the high limit value is not met, an error message will appear and the setting value will not be confirmed. Input values that meet the above condition, and press the ENT button.

### 7-2. Comp. Mode Setting

Set the conditions for judging high limit and low limit.

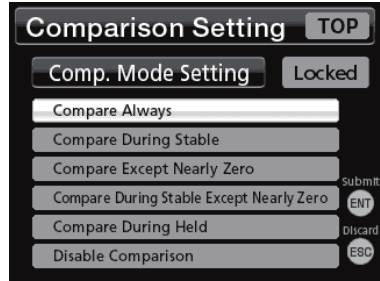

#### NOTE

Compare During Stable, Compare Except Nearly Zero and Compare During Stable Except Nearly Zero comparison modes are closely related to Motion Detect and Nearly Zero functions. See "6-2. Motion Detect" and "7-4. Nearly Zero" for details.

## 7. Comparison Setting

### 7-3. Hysteresis

This function applies a width to switching from ON to OFF for high limit and low limit judgment display.

If the indicator value fluctuates near a value, causing judgment display to chatter between ON and OFF, adjustment of the hysteresis value can prevent this chattering.

The operation of hysteresis changes as follows according to the Comp. Pattern Setting.

For limit boundary values that are greater than the OK position, it operates in the negative direction. For limit boundary values that are less than the OK position, it operates in the positive direction.

When the Comp. Pattern Setting is LO/OK/HI, hysteresis activates for the high limit value when an indicator value decreases.

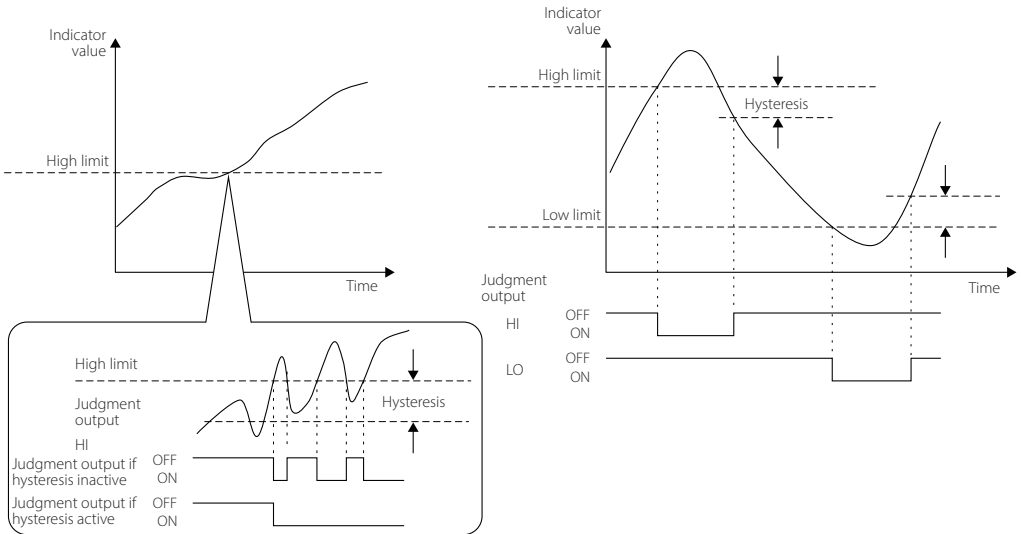

Judgment display conditions (when Comp. Output Pattern is set to Standard Output)

Judgment type	Status	Condition
HI	OFF → ON	High limit value < indicator value
	ON → OFF	Indicator value ≤ (high limit value – hysteresis setting value)
LO	OFF → ON	Indicator value < low limit value
	ON → OFF	(Low limit value + hysteresis setting value) ≤ indicator value

#### ATTENTION

Set the hysteresis setting value so that it meets the following conditions.

Low limit value < (high limit value – hysteresis setting value)

#### NOTE

- The same Hysteresis Width setting is used with high limit and low limit values.
- If set to "0", hysteresis will be disabled.





### 7-4. Nearly Zero

Set the range in which indicator values are evaluated as being nearly zero.



#### NOTE

The Nearly Zero judgment result is closely related to high limit and low limit judgment display.

See "7-2 Comp. Mode Setting" on page 47 for details.

# 8. Hold Function Setting

---

## 8-1. Hold Mode

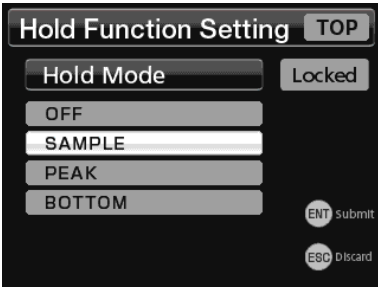

Hold Mode has four settings.

**OFF**

No hold

**SAMPLE**

Sample and hold

**PEAK**

Peak hold

**BOTTOM**

Bottom hold

**NOTE**

Press and hold the ENT button to turn hold on/off. The hold status is shown at the bottom of the display.

### 8-1-1. Sample and hold

Press and hold the ENT button to hold the indicator value.

Press and hold the ENT button to hold the indicator value, and press and hold it again to stop holding the value.

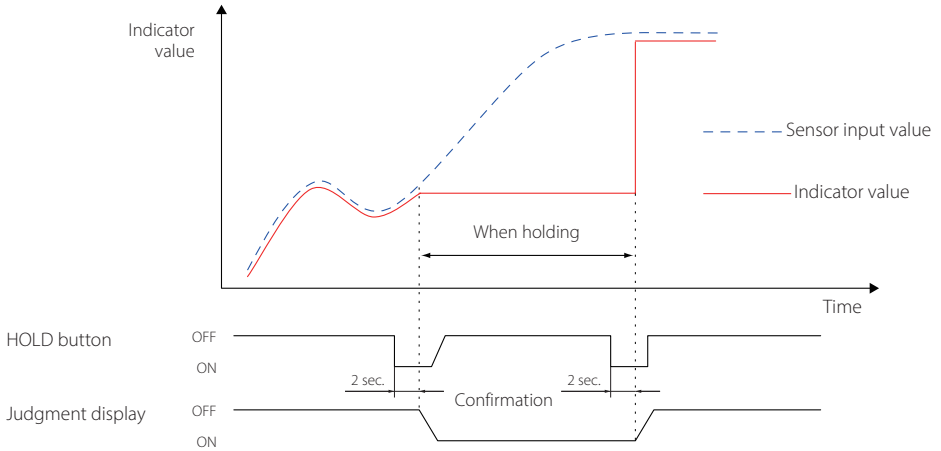

- Judgment display output behavior depends on the comparison mode. The above illustration shows operation when set to Compare During Held.
- Zone Definition cannot be used with the sample and hold mode.
- When using the sample and hold mode, you cannot use the ESC button.

### 8-1-2. Peak hold

#### 8-1-2-1. No zone definition

After pressing and holding the ENT button to turn hold on, the maximum value (peak value) in the indicator value positive direction is shown held. Press and hold the ENT button again to turn hold off, clearing the peak hold.

When holding, the peak value is also reset by pressing the CLEAR (ESC) button.

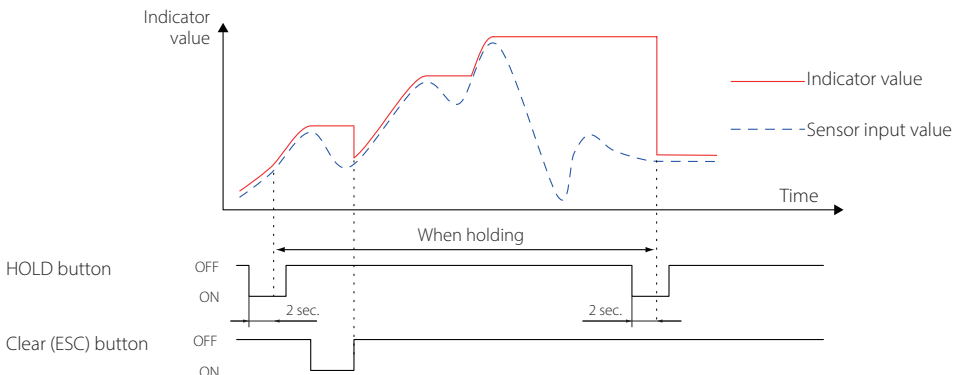

## 8. Hold Function Setting

### 8-1-2-2. Zone definition used

The indicator value when the hold operation completes continues to be shown. When holding, the peak value is reset by pressing the CLEAR (ESC) button.

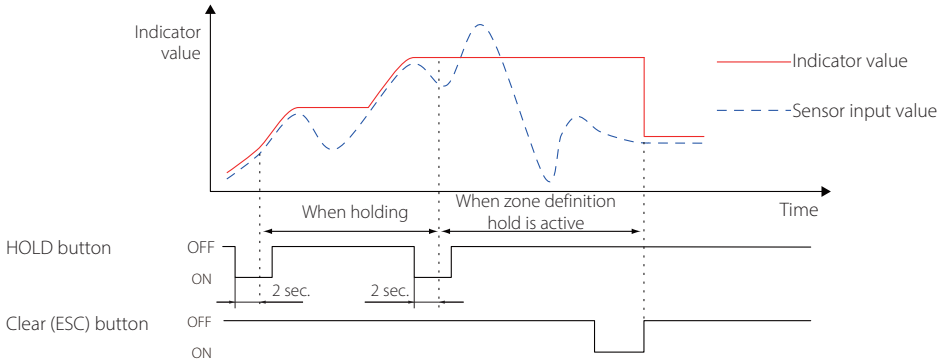

### 8-1-3. Bottom hold

#### 8-1-3-1. No zone definition

Press and hold the ENT button to turn hold on and hold and display the minimum (bottom) indicator value. Press and hold the ENT button again to turn hold off, clearing the bottom hold.

When holding, the bottom value is also reset by pressing the CLEAR (ESC) button.

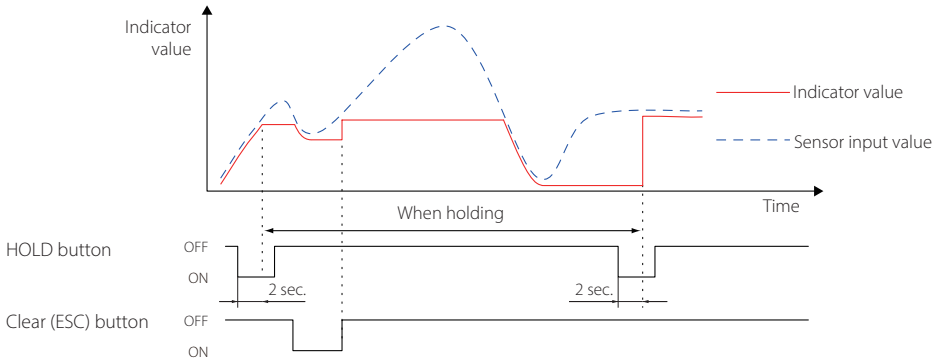

### 8-1-3-2. Zone definition used

The indicator value when the hold operation completes continues to be shown.  
When holding, the bottom value is reset by pressing the CLEAR (ESC) button.

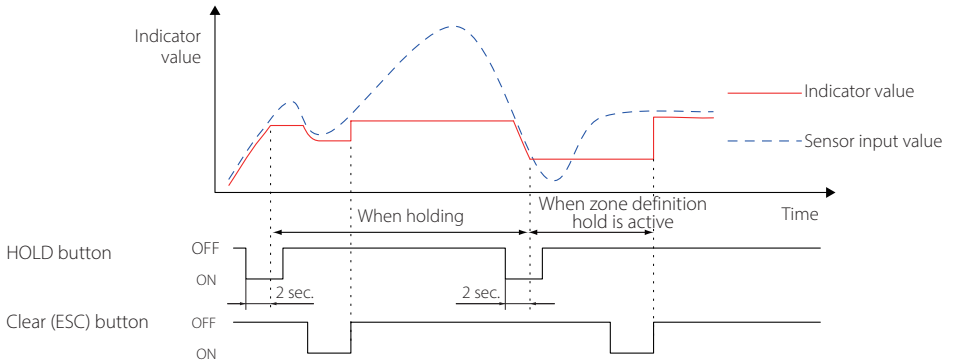

## 8. Hold Function Setting

### 8-2. Zone Definition

When set to ON, the indicator value will continue to be shown after the hold ends.

Pressing the CLEAR (ESC) button will clear the held value.

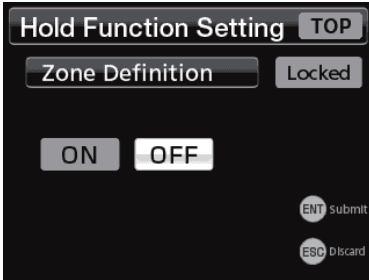

Options: ON, OFF

### 8-3. Auto Zero

Set whether or not to automatically execute a Digital Zero when a hold starts (ON/OFF).

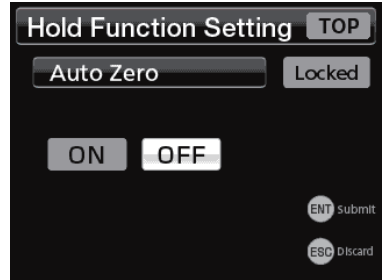

ON: automatically execute the Digital Zero function when a hold starts

OFF: do not automatically execute the Digital Zero function when a hold starts

## 9-1. Time axis setting (X)

Set the width of the time axis.

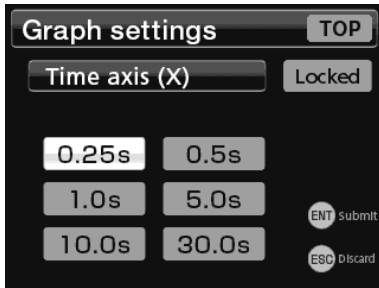

## 9-2. Indicator value axis setting (Y)

Set the range of indicator values displayed.

- This is reflected simultaneously by the bar meter horizontal axis.

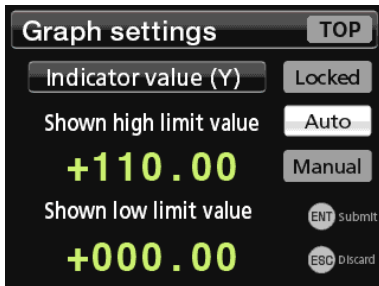

### Auto

The display range is from 0 to the maximum value of 110%

### Manual

If you select "Manual", the following setting items can be input so you can set the display range.

### Shown high limit value

This is the maximum value on the graph's vertical axis.

### Shown low limit value

This is the minimum value on the graph's vertical axis.

## 9-3. Trigger mode

Enable/disable trigger operation

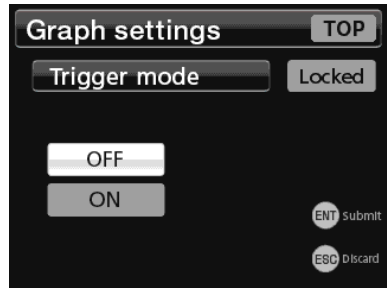

### OFF

Trigger disabled

### ON

Trigger enabled

## 9-4. Trigger

### 9-4-1. Trigger polarity

Set the direction of indicator value change for trigger operation.

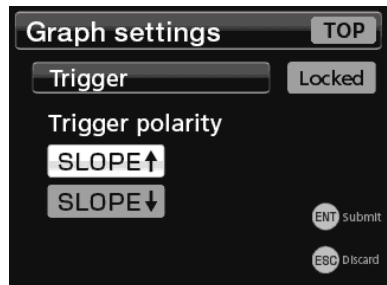

### SLOPE ↑

Trigger operation occurs when the input signal changes from a value lower than the trigger level to higher than it.

### SLOPE ↓

Trigger operation occurs when the input signal changes from a value higher than the trigger level to lower than it.

## 9. Graph settings

---

### 9-4-2. Trigger level

Set the indicator value level that causes trigger operation.

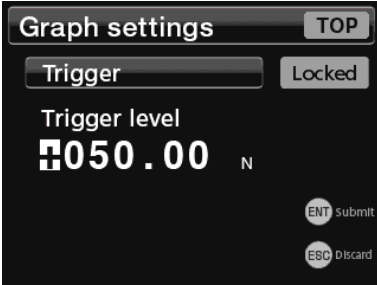

The trigger point is when the indicator value reaches the set trigger level value from the direction set by the trigger polarity.

### 9-4-3. Trigger position

This sets the display position of the cursor.

0% is the left end of the X axis and 100% is the right end.

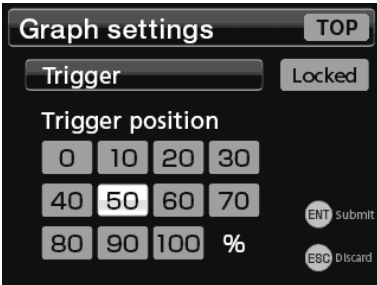



# 10. System settings 1

## 10-1. Setting Memory

You can save up to 6 memories with setting values and switch among them.

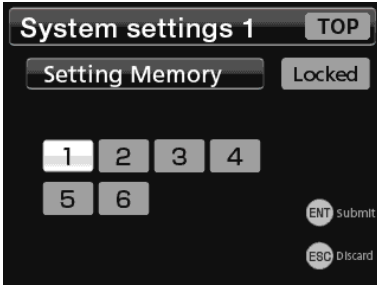

The setting currently in use is selected. Move the selection and press the ENT button to change the setting.

- There are no setting value saving or loading menu operations.
- You cannot copy between setting memories.

When shipped from the factory, memory 1 to 6 are set at default values.

See the setting value list for the setting values that can be saved in memories 1 to 6.

### ATTENTION

Putting the unit in standby while writing setting values will not only cause the values to not be recorded, it might also corrupt the memory. Do not put the unit into standby when a setting screen is open.

## 10-2. D/A Converter

The D/A Converter allows for analog output that corresponds to the unit indicator value.

The analog output range can be set to either  $\pm 1V$  or  $\pm 2V$  voltage output.

You can achieve analog output from zero (0 V) to full scale ( $\pm 1 V$  or  $\pm 2 V$ ) according to the digital values set using D/A Zero and D/A Full Scale settings.

The conversion speed is 1000 times/second.

Connect an external device with a load resistance of 2 k $\Omega$  or more.

### 10-2-1. D/A output

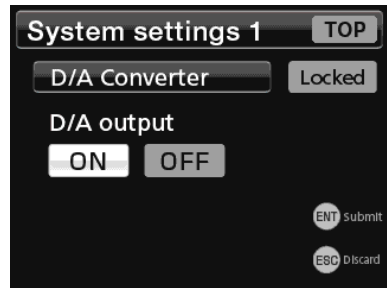

#### ON

Output enabled

#### ATTENTION

With static strain display, analog output will be zero.

#### OFF

Output disabled

### 10-2-2. D/A Zero

Set the indicator value that you want to output for D/A Zero (0V voltage).

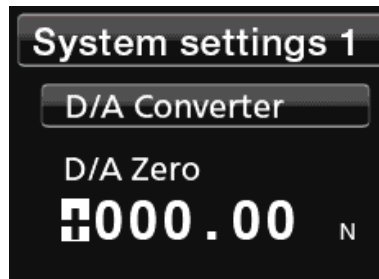

## 10. System settings 1

### 10-2-3. D/A Full Scale

With the "10-2-2. D/A Zero" value as the reference, set the span for the indicator values output to D/A.

When the "10-2-2. D/A Zero" and "10-2-3. D/A Full Scale" setting values are added, the "10-2-4. D/A Max. Voltage" setting value is output.

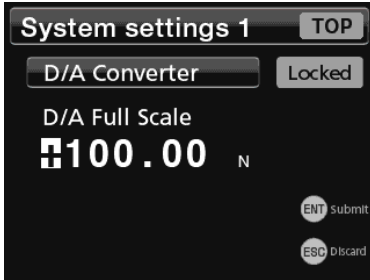

The following is an example of when "10-2-4. D/A Max. Voltage" is set to 1 V.

Setting example 1

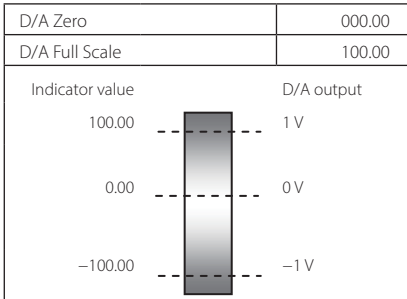

Setting example 2

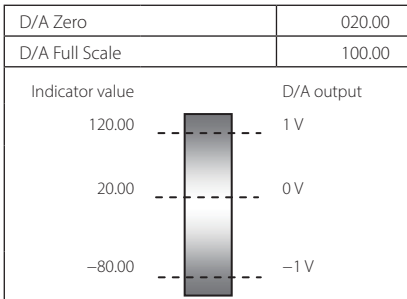

Setting example 3

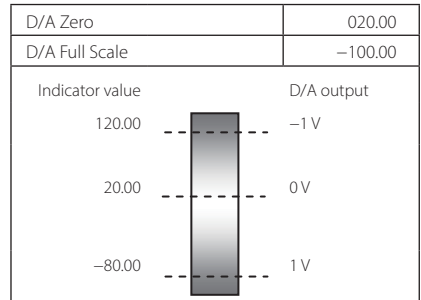

Setting example 4

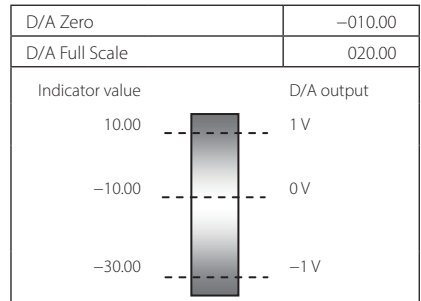

#### ATTENTION

If calibration is conducted, when the rated capacity is confirmed, it will be set as the D/A Full Scale value.

### 10-2-4. D/A Max. Voltage

Set the maximum D/A voltage. The load also uses the same output voltage range. For example, when set to 1V, +1 V will be output when the "10-2-2. D/A Zero" and "10-2-3. D/A Full Scale" setting values are added.

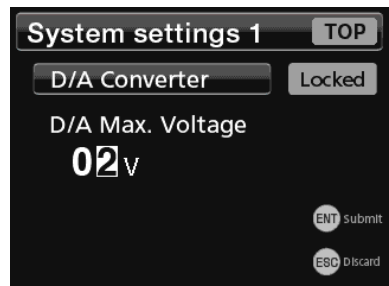

10-2-5. D/A CAL TEST

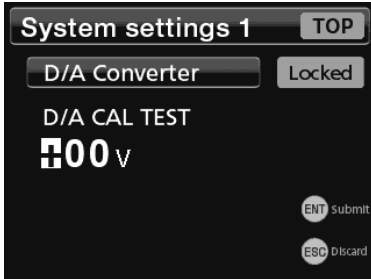

When the D/A CAL TEST screen is open, the voltage value shown on the display is output from the D/A. The D/A output changes each time a setting is changed.

10-3. Lock

10-3-1. Cal. Value Lock

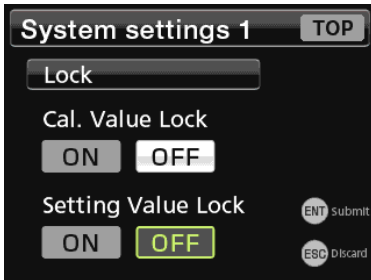

See "4-10 Setting value list" on page 29 for information about settings that cannot be changed when Cal. Value Lock is ON.

10-3-2. Setting value lock

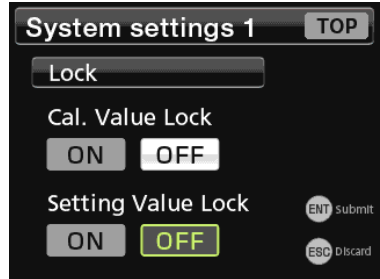

See "4-10 Setting value list" on page 29 for information about settings that cannot be changed when Setting Value Lock is ON.

10-4. Brightness

Adjust the brightness of the LCD screen backlight and the time until it dims.

10-4-1. Brightness

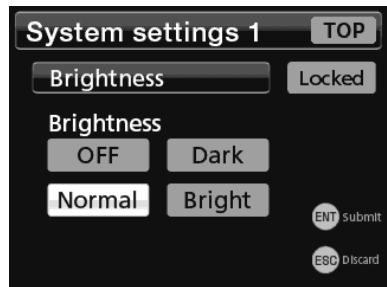

Select Bright, Normal, Dark or OFF.

**NOTE**

Even when set to OFF, the backlight will light at normal brightness for 5 seconds whenever you press a button. Button operations are only enabled when the backlight is lit.

## 10. System settings 1

### 10-4-2. Backlight dimmer



This can be used to set the time until the backlight dims after the last button press (in 1-second intervals up to 60 seconds).

- Set it to 0 seconds to disable dimming.

#### NOTE

When dimmed, the backlight will light at the original brightness level whenever a button is pressed.

### 10-5. Auto power off

Set the amount of time without any button operations until the unit enters standby.

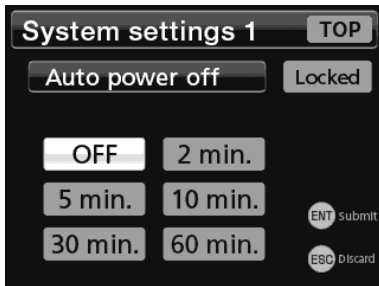

Select OFF, 2 min., 5 min., 10 min., 30 min or 60 min.

- When the unit is connected by USB (using bus power), the backlight will turn off, but the unit will not enter standby.

### 10-6. Languages

You can select the language used for display. The options are Japanese and English.



## 10. System settings 1

### 10-7. Reset to the Factory Settings

You can restore settings to their default values (initialize them).

Select **Execute** and press the ENT button.

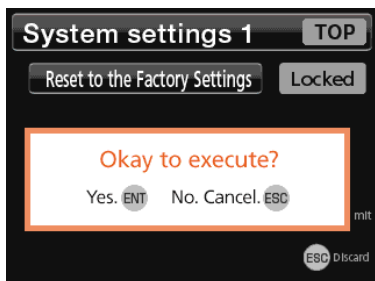
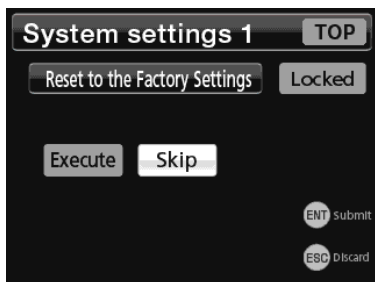

After resetting to defaults completes, the Home Screen opens.

#### NOTE

Only the current Setting Memory is reset.  
Items in "4-10-1 Calibration" on page 29 are not reset.

#### ATTENTION

Always put the unit into standby once after executing the "Reset to the Factory Settings" command.

## 11. System settings 2

### 11-1. Device number

You can give this unit a unique number.

Do this when using multiple TD-01 Portable units, for example.



### 11-2. Date & time setting

Set the unit's built-in clock.

The clock time is shown on the Home Screen and saved with recorded data.

#### 11-2-1. Date display format

Select the date display format.

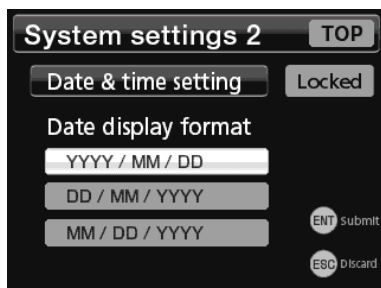

[YYYY/MM/DD]

[DD/MM/YYYY]

[MM/DD/YYYY]

- The abbreviations are as follows.  
YYYY: 4-digit AD year  
MM: 2-digit month  
DD: 2-digit day

## 11. System settings 2

### 11-2-2. Date & time setting

Set the current date and time.



- Press the ENT button after setting all items.

### 11-3. Battery type

Set the type of AA batteries. This is used to estimate remaining battery charge.

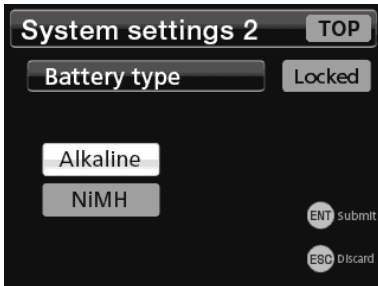

#### Alkaline

Using alkaline batteries

#### NiMH

Using NiMH batteries

### 11-4. Indicator recording mode

See "2-2 Indicator recording mode" on page 21.

### 11-5. Recorded data deletion

Saved indicator values and graph data can be deleted.

You can select which data is deleted first using "Indicator" and "Graph" at the top right of the screen.

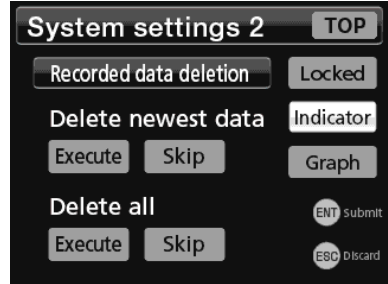

#### Delete newest data

Select "Execute" to delete the most recently saved data.

#### Delete all

Select "Execute" to delete all data.

A confirmation screen will open if you select "Execute". Press the ENT button to delete.

Press the ESC button to cancel deletion.

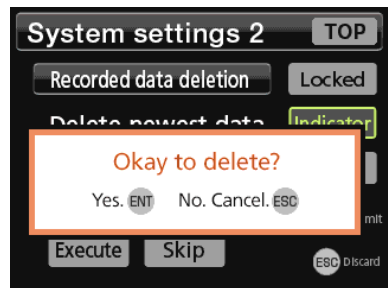

## 12. TEDS Settings

By connecting a sensor that supports IEEE1451.4 Transducer Electronic Data Sheets (TEDS) to the unit, the Rated Output stored in the sensor can be loaded and this can be applied to calibration of the indicator with this function.

In addition, the value calibrated by the unit itself can be loaded to the TEDS sensor or its original value can be restored.

This function supports functions with TEDS sensors as shown below.

Note, however that equipment with TEDS memory includes both 1kbit and 4kbit devices, but the unit only supports 4kbit.

TEDS standard			
IEEE 1451.4 (V0.9)	IEEE1451.4 (V1.0)		
	Template ID		
	Bridge Sensors (33)	Strain Gauge (35)	Other
-	✓	✓	-

- ✓ TEDS calibration supported
- Not supporte

### 12-1. TEDS Data

Select TEDS Data to show the following items.

- Serial number
- Rated capacity
- Rated capacity unit
- Rated output
- Bridge Element Impedance
- Max. Exc. Level
- Calibration Date

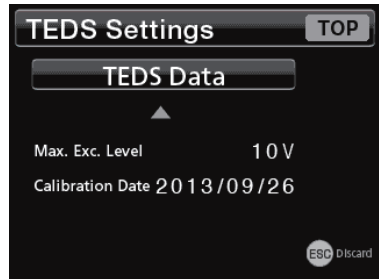
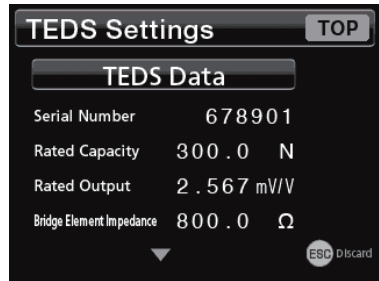

Press the ESC button to exit TEDS data display mode.

## 12. TEDS Settings

### 12-2. TEDS Data Change

The current calibration values (rated capacity, rated capacity unit and rated output) and calibration date will be written to the TEDS memory.

Only units supported by the TEDS specification will be written.

- 1 Press the MENU button to open the Function Menu, and select in order TEDS Settings → TEDS Data Change.

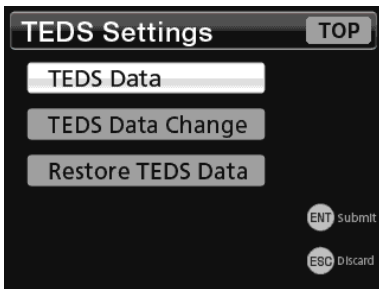

- 2 Input 00015 and press the ENT button twice.

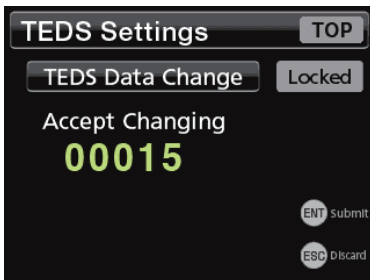
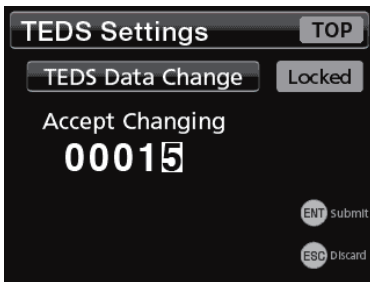

#### NOTE

- This value must be input to prevent accidental data change.
- Press the ESC button to cancel and exit setting mode.

- 3 Input the calibration date, and press the ENT button twice.

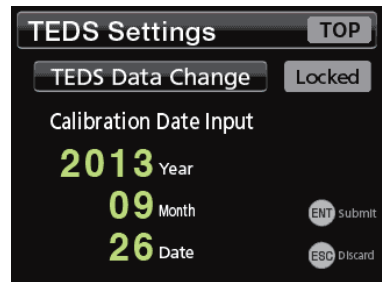

While the calibration value is being written, "Writing Cal. Data" appears.

After the calibration value has been written, TEDS Settings appears and is ready for button input.

Press the ESC button to exit setting mode.



### 12-3. Restore TEDS Data

Use this to restore the factory default calibration value of a sensor to which data was written using the TEDS Data Change procedures above.

- 1 Press the MENU button to open the Function Menu, and select in order TEDS Settings → Restore TEDS Data.

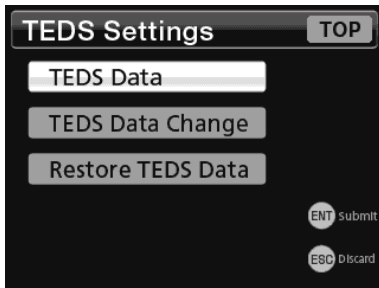

- 2 Input "00015".

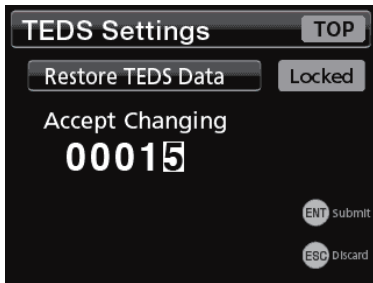

#### NOTE

- This value must be input to prevent accidental data change.
- Press the ESC button to cancel and exit setting mode.

- 3 Press the ENT button to restore the data from the TEDS memory. "Executing" appears while this occurs.

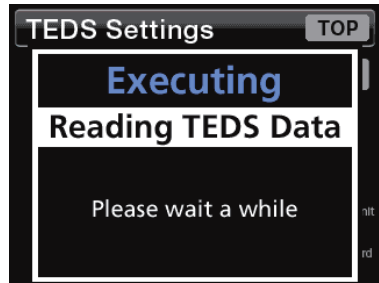

When writing the TEDS memory restoration data completes, the rated output (mV/V) and rated capacity are shown so you can check the values.

#### NOTE

Press the ESC button to cancel and exit setting mode.

- 4 Press the ENT button to write the data to the TEDS memory. "Writing TEDS data" appears while this occurs.

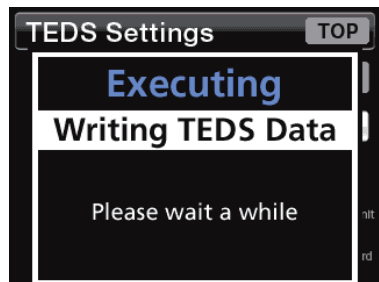

## 13. Error message list

Message	Explanation
LOAD	ADC plus over
-LOAD	ADC minus over
FULL	Display plus over (greater than maximum display value)
-FULL	Display minus over (less than minimum display value)
OVER FULL	Input is exceeding maximum input range (5.2 mV/V)
-OVER FULL	Input is less than minimum input range (-5.2 mV/V)
ZERO OVER	Zero balancing range exceeds regulated values
ZERO ERROR	Zero-adjusting failed within specified time
OUTPUT CAL OVER	Sensor output exceeds calibration range
OUTPUT CAL SHORT	Sensor output does not achieve calibration range
MINUS INPUT	Sensor input is negative
TEDS READ ERROR	A valid TEDS sensor is not connected
PARAMETER ERROR	Irregular setting value exists
R.O. SET OVER	Rated output exceeds the set range (greater than 5.0 mV/V)
R.O. SET SHORT	Rated output below the set range (less than 0.3 mV/V)
ZERO LIMIT OVER	Digital Zero Limit exceeded
ERROR	An error has occurred
DA OVER	DA output is outside output range
DA -OVER	DA output is outside output range
SYSTEM ERROR	A system error has occurred
INVALID OPERATION	Operation is invalid
MEMORY FULL	Memory for saving data is full. Delete data or enable overwriting using "System settings 2".

Message	Explanation
Zero Balancing	Please wait a while
Executing Digital Zero	Please wait a while
Reading TEDS data	Please wait a while
WRITING DATA	Do not operate the unit until writing completes.

## 14. Warranty explanation

---

- The warranty period for this device is one year from the date of purchase.
- Be aware that repairs will require payment in the following cases even during the warranty period.
  - 1) Malfunction or damage due to misuse
  - 2) Malfunction or damage caused by modifications or repairs conducted by any party other than our or a service person designated by our company
  - 3) Malfunction or damage caused by dropping, transportation or similar handling after product delivery
  - 4) Malfunction or damage caused by fire, earthquake, water, lightning or other natural disaster
  - 5) Malfunction or damage caused by external factors, including power supplies and equipment environmental conditions, that deviate from the operation requirements of this product
  - 6) Malfunction or damage if the product was not purchased from our company or an agent designated by our company
- We offer paid service after the conclusion of the warranty period. For details, please contact the retailer where you purchased the unit or a contact on the back cover of this manual.
- Be aware that our company will bear no responsibility for any secondary damages resulting from the operation of this device or related to data.
- Be aware that our company will bear no responsibility if data recorded by this device is deleted as a result of misoperation or unexpected incident, for example.
- Information is given about products in this manual only for the purpose of example and does not indicate any guarantees against infringements of third-party intellectual property rights and other rights related to them. TEAC Corporation will bear no responsibility for infringements on third-party intellectual property rights or their occurrence because of the use of these products.

## 15. Specifications

Compatible sensors		Strain gauge transducer
Signal input terminals		Round connector (NDIS7P)/terminal bank (connect only one at a time)
Excitation Voltage		DC, 2.5 V $\pm$ 5% (30mA maximum current)
Signal input range		$\pm$ 5 mV/V
Equivalent input/ TEDS	Calibration range	0.3 mV/V – 5.0 mV/V
	Calibration precision	Within 0.1% F.S. (when using a 1m standard TEAC $\Phi$ 8, 6-core shielded cable with 350 $\Omega$ impedance, when 5mV/V)
Precision	Linearity	Within 0.01% F.S. + 1 digit (when 5mV/V)
	Zero drift	Within 0.5 $\mu$ V/ $^{\circ}$ C (input conversion value)
	Gain drift	0.005%/ $^{\circ}$ C or less
A/D conversion		1000 times/second, 24-bit
Digital filter		Moving average (select from OFF, 16, 32, 64, 128, 256, 512, 1024, 2048)
D/A output	Output connector	BNC
	Output voltage	$\pm$ 2.0 V
	Resolution	70.16 $\mu$ V typ
	Linearity	0.02% F.S. or less
	Zero drift	0.1 mV/ $^{\circ}$ C or less
	Gain drift	0.003%/ $^{\circ}$ C or less
TEDS function		IEEE1451.4 class 2 mix mode interface
Display	Display	2.4" color TFT LCD
	Display modes	Setting screens, indicator value digital display, graph display, recorded data list display, static strain display
	Languages	Japanese/English
Indicator value	Display range	–99999 to 99999
	Decimal point	Display position selectable
Displayed items	Calibration settings	Zero calibration/span calibration (TEDS calibration, actual load calibration, equivalent input calibration)
	Function settings	High limit, low limit, comparison mode, hysteresis, nearly zero, moving average, motion detect, zero tracking, digital zero, digital zero offset, zone definition, hold mode, control lock, minimum grid, digital zero limit, clear digital zero, select data output, D/A converter
Hold functions		Sample hold, peak hold, bottom hold, zone definition hold (peak, bottom)
Data recording	Indicator value	300 maximum Recorded contents: ID number, date and time, recording mode, sensor value memory number, indicator value
	Graph recording	8 maximum Recorded contents: ID number, date and time, sensor value memory number, trigger mode, graph waveform
Power supply		4 alkaline or NiMH AA batteries USB bus power (built-in Micro-USB B connector)
Operating temperature range		0 $^{\circ}$ to 40 $^{\circ}$ C
Storage temperature range		–20 $^{\circ}$ to 60 $^{\circ}$ C
Operating humidity range		85% RH or less (without condensation)
Applicable standards		CE marking, VCCI (Class A), FCC (Class A), UKCA marking
External dimensions (W $\times$ H $\times$ D)		Approximately 85 mm $\times$ 140 mm $\times$ 35 mm (without protrusions)
Weight		About 320 g (including batteries)

- Specifications and appearance are subject to change without notice.
- Weight and dimensions are approximate.
- Illustrations in this document might differ slightly from production models.

## 16. External drawings

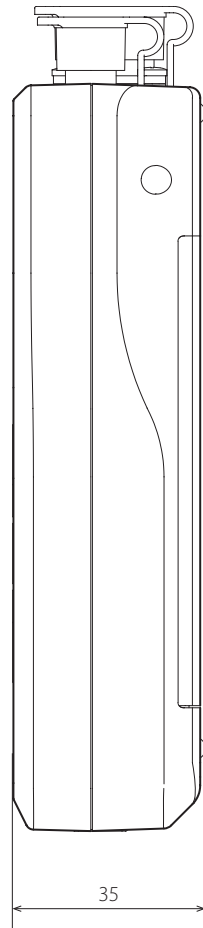
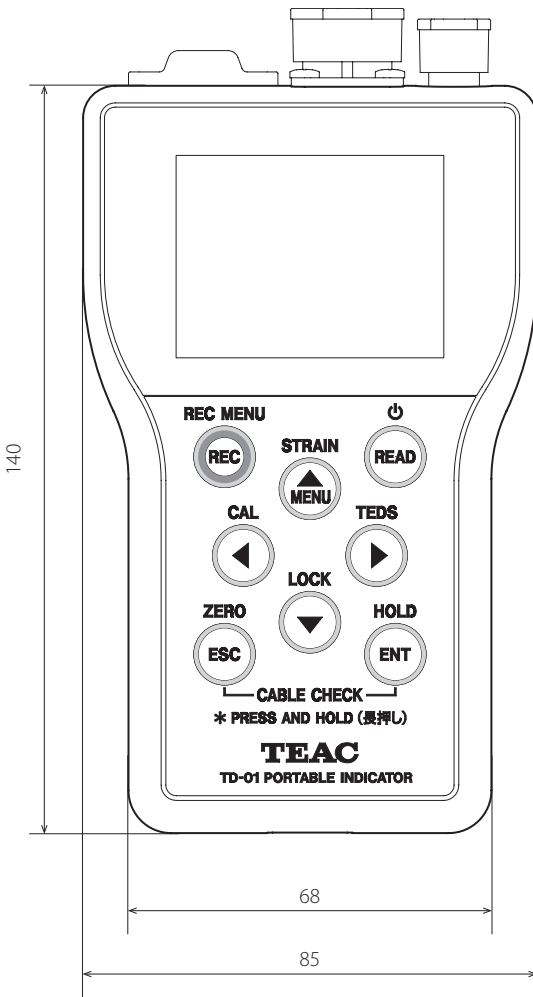
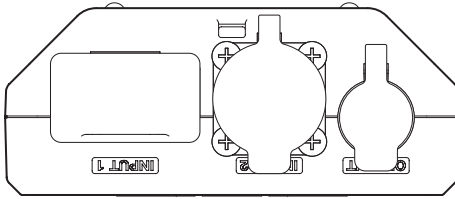

Dimensions in millimeters (mm)

# 17. Block diagram

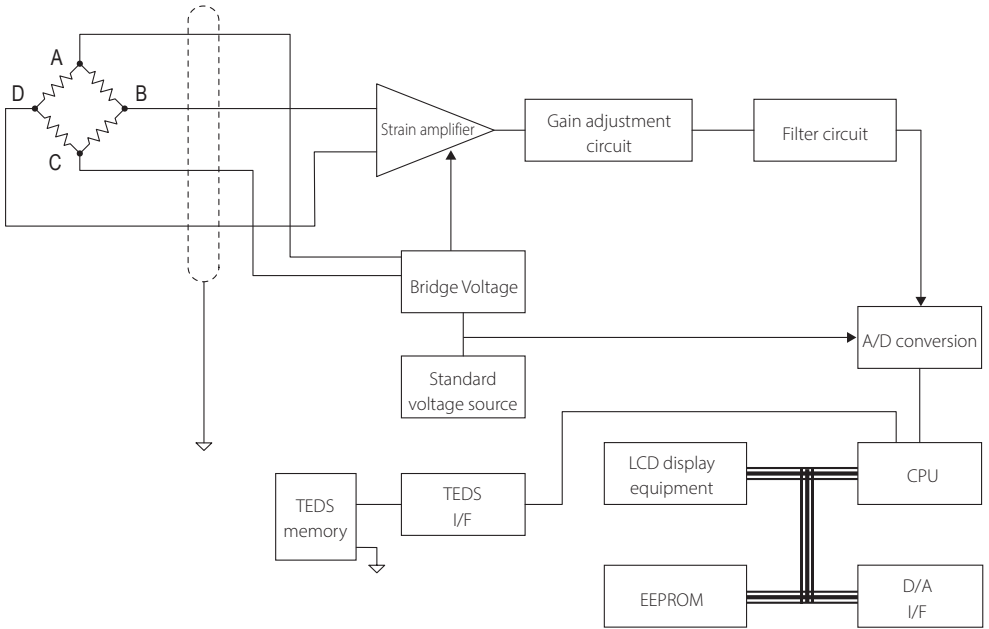



# TEAC

---

TEAC CORPORATION	1-47 Ochiai, Tama-shi, Tokyo 206-8530, Japan	Phone: +81-42-356-9154
TEAC AMERICA, INC.	10410 Pioneer Blvd. Unit #1, Santa Fe Springs, California 90670, U.S.A.	Phone: +1-323-726-0303
TEAC EUROPE GmbH. (EU Importer)	Bahnstrasse 12, 65205 Wiesbaden-Erbenheim, Germany	Phone: +49-(0)611-7158-349
TEAC UK Limited (UK Importer)	Luminous House, 300 South Row, Milton Keynes, Buckinghamshire, MK9 2FR, UK	Phone: +44-1923-797205
TEAC SALES & TRADING (ShenZhen) CO., LTD.	Room 817, Xinian Center A, Tairan Nine Road West, Shennan Road, Futian District, Shenzhen, Guangdong Province 518040, China	Phone: +86-755-88311561-2

---